

---

Masters Theses

Student Theses and Dissertations

---

Spring 2007

## Diversity techniques for signal-strength based indoor location determination

Anil Ramachandran

Follow this and additional works at: [https://scholarsmine.mst.edu/masters\\_theses](https://scholarsmine.mst.edu/masters_theses)



Part of the [Computer Engineering Commons](#)

Department:

---

### Recommended Citation

Ramachandran, Anil, "Diversity techniques for signal-strength based indoor location determination" (2007). *Masters Theses*. 6824.

[https://scholarsmine.mst.edu/masters\\_theses/6824](https://scholarsmine.mst.edu/masters_theses/6824)

This thesis is brought to you by Scholars' Mine, a service of the Missouri S&T Library and Learning Resources. This work is protected by U. S. Copyright Law. Unauthorized use including reproduction for redistribution requires the permission of the copyright holder. For more information, please contact [scholarsmine@mst.edu](mailto:scholarsmine@mst.edu).



DIVERSITY TECHNIQUES FOR SIGNAL-STRENGTH  
BASED INDOOR LOCATION DETERMINATION

by

ANIL RAMACHANDRAN

A THESIS

Presented to the Faculty of the Graduate School of the

UNIVERSITY OF MISSOURI-ROLLA

In Partial Fulfillment of the Requirements for the Degree

MASTER OF SCIENCE IN COMPUTER ENGINEERING

2007

Approved by

---

Jagannathan Sarangapani, Advisor

---

Can Saygin

---

Scott Christopher Smith

© 2007

Anil Ramachandran

All Rights Reserved

## **PUBLICATION THESIS OPTION**

This thesis consists of the following two articles that have been submitted for publication as follows:

Pages 1-52 are intended for submission to the ACM TRANSACTIONS ON SENSOR NETWORKS.

Pages 53-93 are intended for submission in INTERNATIONAL JOURNAL OF DISTRIBUTED SENSOR NETWORKS.

## ABSTRACT

Diversity techniques have been found in the literature to be suitable for compensating channel uncertainties such as multipath fading. In this thesis, we exploit spatial and frequency diversity techniques for improving accuracy in locating stationary and mobile objects in the indoor environment. First, spatial and frequency diversity techniques are introduced for small scale and temporal variation compensation of received signal strength and it is demonstrated analytically that it in fact enhances location accuracy. A novel metric is introduced in selection combining in order to achieve location accuracy through the addition of diversity upon two of the available location determination schemes. The results are evaluated experimentally against the case where there is no diversity for reception by using low cost wireless RF devices such as motes. An asset location tracking system is then devised to both improve accuracy and predict asset movement. Spatial diversity on the order of twice the wavelength and frequency diversity in terms of channel spacing of 55 MHz are evaluated and shown to provide a reduction in location determination error of 36% and 20%, respectively, when compared to a system without diversity. Finally, results from frequency diversity are compared against the spatial diversity techniques in terms of improvement in location accuracy, transmitter power consumption, and hardware and processing costs.

## ACKNOWLEDGMENTS

I am extremely grateful to my advisor, Dr. Sarangapani, for the encouragement and guidance he has given me and the extreme patience he has shown in my completing this work. He has also given me sufficient freedom to explore avenues of research while correcting my course and guiding me at all times. I thank Dr. Saygin and Dr. Smith, my committee members, for the help and support they have provided throughout my Masters' degree program. I should especially mention Kainan Cha, Maheswaran Thiagarajan, James Fonda, and Dr. Maciej Zawodniok, without whose help, this effort and its successful completion would not have been possible. Special thanks go to all members of the IMS and AutoID research groups who have stood by me at all times. I express my gratitude to Al Salour, Douglas Trimble, and Bryan Dods of Boeing for financial support during my program, the opportunity to work with Boeing on their RTLS solutions and the valuable experience I gained from it.

On a personal note, I thank my roommates at Rolla and the Keralite community here who have been supportive in all my ventures. Last, but at the top of my list, I thank my parents S. Ramachandran and Dr. Lakshmi Ramachandran, and my sister Archana Ramachandran, for the tremendous encouragement and support I have received throughout my life which has enabled me to face the challenges and achieve success.

## TABLE OF CONTENTS

	Page
PUBLICATION THESIS OPTION.....	iii
ABSTRACT.....	iv
ACKNOWLEDGMENTS .....	v
LIST OF ILLUSTRATIONS.....	ix
LIST OF TABLES.....	xi
 PAPER	
1. Accuracy Improvement Using Spatial Diversity For Signal Strength Based WLAN Location Determination Systems.....	1
ABSTRACT.....	1
I. INTRODUCTION .....	2
II. BACKGROUND .....	7
A. Definitions.....	7
B. Overview of Spatial Diversity.....	8
III. PROPOSED METHODOLOGY .....	11
A. Source of Location Determination Errors .....	11
B. Spatial Diversity and Location Determination.....	15
C. Number of Receivers.....	22
D. Location Determination Algorithm.....	25
1) Probabilistic technique .....	25
2) Deterministic technique.....	27
E. Diversity and Combining .....	27
F. Tracking, Averaging and Prediction .....	29
IV. EXPERIMENTAL RESULTS AND ANALYSIS .....	38



A.	Testbed and Implementation .....	38
B.	Algorithm Pseudocode .....	40
C.	Asset Location Tracking and Averaging.....	41
D.	Results and Analysis .....	42
1)	Spatial diversity and location determination accuracy.....	42
2)	Comparison of HORUS vs. spatial diversity.....	47
3)	Location tracking, averaging and prediction.....	48
V.	CONCLUSIONS.....	51
	REFERENCES .....	51
2.	Use of Frequency Diversity in Signal Strength Based WLAN Location Determination Systems.....	56
	ABSTRACT.....	56
I.	INTRODUCTION .....	57
II.	BACKGROUND .....	62
A.	Definitions.....	62
B.	Overview of Frequency Diversity .....	63
III.	PROPOSED METHODOLOGY .....	66
A.	Source of Location Determination Errors .....	66
B.	Frequency Diversity and Location Determination .....	67
C.	Number of Receivers.....	68
D.	Location Determination Algorithm.....	69
1)	Probabilistic technique .....	69
2)	Deterministic technique.....	70
3)	Diversity and combining .....	70
E.	Location Update Rate and Power Consumption .....	72
F.	Tracking, Averaging and Prediction .....	75

IV. EXPERIMENTAL RESULTS AND ANALYSIS .....	77
A. Testbed and Implementation .....	77
B. Algorithm Pseudocode .....	80
C. Asset Location Tracking and Averaging.....	80
D. Results and Analysis .....	81
1) Frequency and spatial diversity and location determination accuracy.....	81
2) Location update rate and power consumption.....	85
3) Location tracking, averaging and prediction.....	86
V. CONCLUSIONS.....	89
REFERENCES .....	90
VITA.....	94

## LIST OF ILLUSTRATIONS

Figure	Page
<b>PAPER 1</b>	
1.	Normalized correlation coefficient between fading envelopes as function of separation between the antennas..... 9
2.	(a) Two locations <i>A</i> and <i>B</i> and a single receiver <i>i</i> (b) probability density functions of signal strength received from each location at the receiver..... 12
3.	Probability Density Functions of RSSI from locations A and B (a) at Receiver 1 and (b) at Receiver 2..... 14
4.	Reduction in error area from spatial diversity ..... 19
5.	(a) Hardware implementation of spatial diversity and proposed selection combining approach (b) software implementation ..... 28
6.	Layered representation of the proposed method of selection combining ..... 29
7.	Calculation of averaged cumulative <i>x</i> and <i>y</i> motion for nine time units ..... 33
8.	Averaging of located coordinates to report position (lag of 9 units) ..... 35
9.	UMR G4-SSN embedded wireless sensor networking platform ..... 38
10.	UMR-SLU G4-SSN motes arranged for creating spatial diversity with a separation of 25 cms ..... 38
11.	Floor plan of ERL third floor..... 39
12.	Floor plan of ERL second floor ..... 40
13.	Probabilistic technique- offgrid points - (a) cumulative distribution function of location error (b) location error as a function of number of receivers ..... 43
14.	Probabilistic technique, ongrid points - (a) cumulative distribution function of location error (b) location error as a function of number of receivers ..... 43
15.	Deterministic technique, offgrid points - (a) cumulative distribution function of location error (b) location error as a function of number of receivers ..... 44

16.	Deterministic technique, ongrid points - (a) cumulative distribution function of location error (b) location error as a function of number of receivers .....	45
17.	Successful detection of mobile and stationary assets .....	49
18.	Accuracy levels of averaging and prediction techniques for mobile assets....	49
19.	Accuracy levels of averaging and prediction techniques for stationary nodes .....	50
 PAPER 2		
1.	(a) Timer-based implementation of frequency diversity and proposed selection combining approach (b) dual receiver implementation .....	71
2.	Layered representation of the proposed method of selection combining .....	71
3.	UMR G4-SSN embedded wireless sensor networking platform .....	77
4.	Floor plan of ERL third floor.....	79
5.	Floor plan of ERL second floor .....	79
6.	Deterministic technique (a) cumulative distribution function of location error (b) location error as a function of number of receivers.....	82
7.	Probabilistic technique - (a) cumulative distribution function of location error (b) location error as a function of number of receivers.....	83
8.	Battery lifetime vs. location update interval .....	85
9.	Successful detection of mobile and stationary assets .....	87
10.	Accuracy levels of averaging and prediction techniques for mobile assets ( Deterministic technique).....	87
11.	Accuracy levels of averaging and prediction techniques for mobile assets (Probabilistic technique). .....	88

## LIST OF TABLES

Table	Page
<b>PAPER 1</b>	
I :	Pseudocode for probabilistic location determination ..... 40
II :	Pseudocode for deterministic location determination ..... 41
III :	Performance comparison with and without spatial diversity and number of receivers ..... 46
IV:	Summary of location determination error levels ..... 46
<b>PAPER 2</b>	
I	Pseudocode for probabilistic location determination ..... 80
II	Pseudocode for deterministic location determination ..... 80
III :	Performance comparison with and without diversity and number of receivers ..... 84
IV:	Summary of location determination error levels ..... 84

## PAPER 1

### Accuracy Improvement Using Spatial Diversity For Signal Strength Based WLAN Location Determination Systems<sup>1</sup>

Anil Ramachandran and S. Jagannathan\*

Embedded Systems and Networking Laboratory

Department of Electrical and Computer Engineering

University of Missouri-Rolla

**ABSTRACT**— The literature indicates that spatial diversity can be utilized to compensate channel uncertainties such as multipath fading. Therefore, in this paper, spatial diversity is exploited for accuracy improvement in locating stationary and mobile objects in the indoor environment. First, space diversity technique is introduced for small scale and temporal variation compensation of received signals and demonstrated analytically that it in fact enhances location accuracy. A novel metric is introduced for selection combining in order to improve location accuracy through the addition of spatial diversity upon two of the available location determination schemes. The results are evaluated experimentally against a single antenna system for reception by using low cost wireless RF devices such as motes. Alternatively, the impact of the number of location determination devices in a probabilistic WLAN network based on pre-profiling of signal strength is analyzed and it is demonstrated analytically that location accuracy improves with the number of receivers used. An asset location tracking system is then devised to both improve accuracy and predict asset movement. Spatial diversity in terms of the antenna spacing of  $2\lambda$  is evaluated and shown to provide a reduction in location determination error between 30 % and 40 % when compared to a single antenna system. Finally, it is shown that it is cheaper to create diversity compared to increasing the number of locating devices.

**Key words**—Indoor Geo-location, WLAN Location Determination, Spatial Diversity, Location Accuracy.

---

<sup>1</sup> Research supported in part by an Air Force Research Laboratory Grant FA8650-04-C-704.

## I. INTRODUCTION

In industrial and service sectors, real-time locating, tracking of assets and personnel is fast becoming a necessity. Several technologies have been developed and implemented with varying degrees of success. While efforts started with infrared and ultrasonic technologies [1], [2], it was recognized that use of radio frequency (RF) technologies, being easily scalable and deployable, was the option of choice [3], [4] due to low cost and minimal safety concerns because of the absence of wiring. Subsequently, different location determination schemes in the RF domain were developed, which include time of arrival (TOA), time difference of arrival (TDOA), angle of arrival (AOA), and received signal strength (RSSI) etc. [5], [6].

Built-in RF networks now exist in most indoor environments for communication and networking applications and therefore it would be advantageous to utilize the same networks for location determination in the manufacturing shop floor, buildings and other places. Towards this end, time and angle based systems have been developed but they ([5],[6]) are difficult to implement because they require specialized hardware. Signal strength based systems, on the other hand, can be used on all RF networks without additional hardware and are therefore being addressed by many researchers as a cost effective solution for location determination.

The fundamental premise of signal strength-based location determination is that received signal strength indicator (RSSI) at a receiver is a function of the location of the transmitter and thus can be used to identify the location of objects or assets. Therefore, for the past few years, considerable interest has evolved in using RSSI for location determination. RSSI-based location determination systems are classified into

infrastructure and client based systems depending upon where the location determination occurs. In a client-based system, the tracked object measures signal strength received from various access points and using prior information about the position of the access points and pre-profiled data, location determination is performed. RADAR and HORUS are examples of the client based system. RADAR was developed as a deterministic location determination system based on average signal strength received from each reference location [7]. On the other hand, HORUS [8] uses a probabilistic algorithm for location determination.

It is important to notice that, in the client-based location determination system, each tracked object computes its own location. While this option has the advantage of distributed computation, each tracked object platform must have sufficient computational power to identify its location. This might be difficult to implement in power constrained devices such as active RTLS tags which are normally being used for indoor location determination environments, for instance, on a manufacturing shop floor. In addition, the requirements on prior storage are also large. Another issue is that it is difficult to make location information on all assets available in a centrally available interface. There is also a security issue in allowing each device to find its own location since each device would then be aware of coordinates of the area and the radio map.

By contrast, in infrastructure-based location determination, the asset tags / mobile units either report the received signal strength vectors or they act as transmitters and the received signal strength from them are recorded at sniffers placed around the area. The location computation is performed on a central server and is made accessible globally. Such an option enables the use of power constrained transmitter tags to remain in very-



low-power standby modes and transmit their information periodically. Therefore, an infrastructure-based system is addressed in [9]. The work in this paper refers to an infrastructure based system because the current trends in industrial applications warrant the need for such a technology since it minimizes security concerns. We consider the system in which the electronics on the tracked asset act as a transmitter sending its own identity periodically, where the frequency varies depending on how often the application requires updated location information. Additionally, in the available works such as RADAR and HORUS, the effect of the number of receivers on location accuracy is not discussed and analytical justification is not included. By contrast, in the proposed work, we analytically prove that accuracy improves with the number of receivers even though this may be costly. Therefore, we show that by using spatial diversity the cost is minimized while achieving the desired location accuracy.

One of the major challenges facing WLAN location determination is that signal strength of received radio signals is a dynamic parameter and varies widely with changes in the environment due to fading, shadowing etc. [10]. These factors include both small-scale and temporal effects, and such variation puts a limit on the resolution achievable by the location determination system. The developers of HORUS suggest a small scale compensation method [11] based on observing the determined location of each object and perturbing the signal strength vector to better suit a reference location. However, there are several issues with such an approach applied to an infrastructure based system. First, the object has to be located either continuously or often to detect unexpected changes in location. Unfortunately, tags attached to assets for tracking in manufacturing shop floor environments are often energy-constrained and do not transmit frequently [12], making

the perturbation based continuous tracking a practically unviable solution. Second, the suggested perturbation technique is not based on any true physics of radio communication. Finally, the computational overhead due to the perturbation technique is significantly high. By contrast, a novel approach based on space diversity and modified selection combining is introduced in order to overcome the above limitations.

Diversity has been a well-researched topic in the field of communications with the view of combating fading. It involves combining multiple uncorrelated signal envelopes in order to obtain a signal with a higher signal to noise ratio (SNR). Several methods for signal combining have been developed [13] targeting SNR improvement. For location determination, achieving higher SNR does not automatically result in better accuracy unless consistent received signal strength is achieved.

In the proposed work, it is demonstrated that spatial diversity can be employed to effectively reduce the variation in received signal strength values and as a result, improved accuracy is achieved in location determination. A new combining method is introduced and is shown to reduce variance in signal strength when used with spatial diversity. The combination of spatial diversity and the proposed combining is shown to enhance the location accuracy of objects or assets. The impact of the number of receivers on location determination accuracy is analyzed and it is shown that diversity techniques provide an effective method for compensating small scale and temporal variations and locating objects accurately. It is shown that, for a given number of receivers, a system using spatial diversity with the proposed combining will perform better than one without diversity. Experimental results using wireless UMR motes are included and demonstrate highly satisfactory performance, which indeed verifies our theoretical conjecture.

The paper is organized as follows. Section II presents the background on spatial diversity. Section III presents the proposed methodology, analytical results and the implementation. Section IV presents and discusses hardware results. Section V concludes the paper and discusses avenues for future work.

## II. BACKGROUND

In order to proceed, the following definitions are required. Subsequently, an overview of spatial diversity is discussed.

### A. Definitions

*RSSI (Received Signal Strength Indication)*: The average received signal strength at a given receiver during the reception of a packet, expressed in dBm, is known as *RSSI*.

*Diversity*: The use of multiple signal sources in order to improve the quality of the received signal is known as *diversity*. The different signal sources are referred to as *diversity branches*.

*Spatial Diversity*: An antenna configuration of two or more signal sources that are physically spaced apart (spatially diverse) to combat signal fading is known as *Spatial Diversity*.

*Uncorrelated fading envelopes*: When a diversity scheme is capable of ensuring minimal correlation between the received signal strength values from multiple input signal sources (multiple antennas in case of spatial diversity), such a scheme is said to result in *uncorrelated fading envelopes*. When the input channels in a diversity scheme are uncorrelated, effective mitigation of fading can be accomplished.

*Selection Combining*: The method of selecting one out of multiple signal sources in a diversity scheme by using SNR (select the one with higher SNR) as a criterion is known as *Selection Combining*.

In the proposed approach, the SNR criterion is replaced by *RSSI* (select the one with higher *RSSI*) since *RSSI*, and not SNR, is a representative function of transmitter location.

### ***B. Overview of Spatial Diversity***

The variations in signal strength can be classified into large-scale, small-scale and temporal variations [8]. Signal strength dependent location determination is based on large-scale variations of signal strength with distance, since this allows distinction between different locations. Small-scale variations in signal strength are caused by asset movements of the order of a fraction of a wavelength and are detrimental to accuracy in location determination. Additionally, temporal variations happen over time due to human activity and environmental changes. In other words, the source of error in both small-scale and temporal variations in terms of significant reduction in received signal strength is caused by destructive fading occurring at the receiver from multiple paths. To combat such fading of wireless signals, multiple uncorrelated fading channels are employed at each receiver.

Motivation for use of diversity techniques stems from the fact that the probability of simultaneous deep fading occurring on two uncorrelated fading envelopes (resulting from spatial diversity) is much lower than the probability of a deep fading occurring on a single branch system [15]. Thus, employing a new selection combining approach on top of any diversity technique which assures sufficiently uncorrelated channels will reduce the variance in signal strength owing to small scale factors which appears to be the major source of location determination errors.

The normalized correlation coefficient  $\rho(\xi)$  between the two fading envelopes from the input sources provided by spatial diversity is expressed as a function of antenna separation [16] as

$$\rho(\xi) \cong J_0^2(2\pi\xi) \tag{1}$$

where  $\xi$  is the separation between two vertical monopole antennas expressed in terms of multiples of the wavelength in use, in our case 2.4 GHz, and  $J_0$  is the Bessel function of the first kind and order zero [17]. Based on this derivation, the normalized correlation coefficient between the fading envelopes drops with antenna separation  $k$  as depicted in Fig. 1.

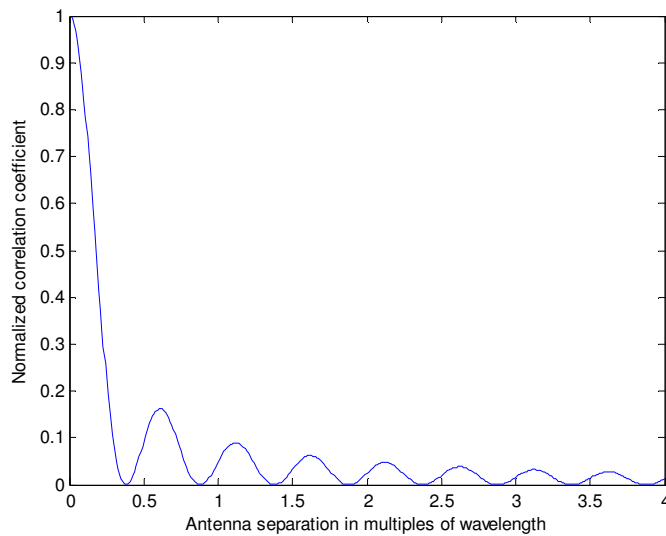

Fig. 1. Normalized correlation coefficient between fading envelopes as function of separation between the antennas

From Fig. 1, it is clear that for a separation of  $2\lambda$  between the antenna elements, the correlation coefficient is around 0.025 and hence the fading envelopes can be shown to be uncorrelated. Further, in [18] experimental results at 1800 MHz indicate that  $2\lambda$  is an acceptable value of separation to ensure almost totally uncorrelated channels.

Hence, in the proposed work, spatial separation of  $2\lambda$  (25 cms for 2.4 GHz) is used to ensure uncorrelated fading channels. Section III shows how the proposed selection combining, employed with a two-branch diversity system, lowers the variation in received signal strength. Consequently, it will be proven that reduced variance in signal strength renders improved location accuracy.

### III. PROPOSED METHODOLOGY

We prove that use of selection combining over two uncorrelated channels results in reduced variance in signal strength provided the selection combining is performed by using the appropriate metric and in an adequate manner. Alternatively, it is demonstrated that by increasing the number of receivers the accuracy can be further enhanced but with an increased cost. Based on this line of thought, actual implementation details of spatial diversity are given. RSSI values from the transmitter are used to arrive at an estimate of its location. An asset location tracking system is developed to determine whether the located asset is moving or stationary. Averaging of consecutive estimated locations of the transmitter is performed to improve location accuracy. For mobile assets, a prediction scheme is developed to identify future location of the asset for tracking applications. First, the source of errors in locating objects is discussed.

#### *A. Source of Location Determination Errors*

The work described in [14] discusses location accuracy for identifying two given points referred to in Fig. 2 (a) as Location  $A$  and  $B$  with one receiver. Let us consider this basic system for error analysis. Initially, a transmitter is placed at location  $A$  and made to transmit repeatedly for a period of time, during which the RSSI values observed at the receiver are recorded. These values are now stored as a signal strength distribution with probability density function (PDF)  $f_A$ . Similarly, the transmitter is placed at location  $B$  and made to transmit for the same period of time and the observed RSSI values at the receiver are stored as a probabilistic distribution with the PDF  $f_B$ . This completes the offline phase. In the online phase, the receiver is placed at location  $A$  and made to



transmit. Let us assume this transmission is collected at the receiver with a RSSI value of  $S_A$ . Now, based on the stored signal strength distributions at the receiver from a transmitter placed at locations  $A$  and  $B$ , the likelihood of the transmission having originated from a transmitter located at  $A$  or  $B$  can be evaluated. Let  $f_A(S_A)$  and  $f_B(S_A)$  be the values on the PDFs  $f_A$  and  $f_B$ , respectively, at the RSSI value of  $S_A$ . Now, if  $f_B(S_A) > f_A(S_A)$  for the observed RSSI value of  $S_A$ , then the location determination system would wrongly decide that the transmission has originated from location  $B$ . Such a case is shown as example in Fig. 2 (b). The integral of  $f_A(S_A)$  over the range of  $S_A$  for which  $f_B(S_A) > f_A(S_A)$  gives the probability of wrong identification of a transmission from location  $A$  as if it is originating from the location  $B$ . This probability is expressed by the shaded area in Fig. 2 (b).

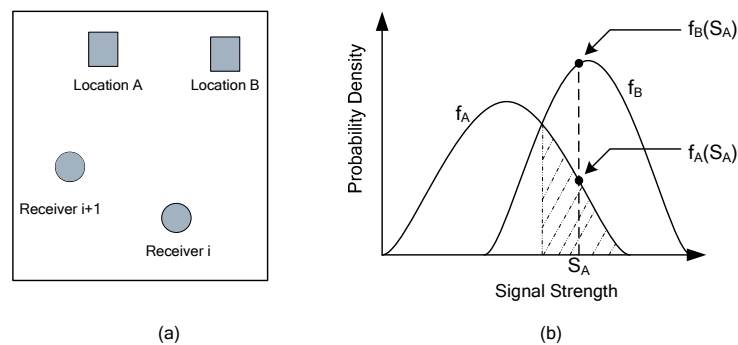

Fig. 2. (a) Two locations  $A$  and  $B$  and a single receiver  $i$  (b) probability density functions of signal strength received from each location at the receiver

This probability can be mathematically expressed as

$$P_1^{A \rightarrow B} = P(f_A(S_A) < f_B(S_A)) \quad (2)$$

where  $P_1^{A \rightarrow B}$  is the probability of wrongly identifying a transmission arriving from location  $A$  as if it is arriving from location  $B$  while using one receiver for distinction,  $S_A$ , the observed RSSI from location  $A$ , is a random variable obeying the PDF  $f_A$  of the RSSI,  $f_A(S_A)$  is the value of the PDF  $f_A$  at the RSSI value  $S_A$ ; and  $f_B(S_A)$  is the value of the PDF  $f_B$  at the RSSI value  $S_A$ .

Now let us add one more receiver to the scenario. In the offline phase, the RSSI values from a transmitter at both locations  $A$  and  $B$  observed at both receivers are individually recorded and stored as PDFs. Let  $f_A^1$  and  $f_B^1$  represent the PDFs of observed RSSI values at receiver 1 from locations  $A$  and  $B$ , respectively, and  $f_A^2$  and  $f_B^2$  be the PDFs of observed RSSI values at receiver 2 from locations  $A$  and  $B$ , respectively. These are depicted in Fig. 3. The receivers are assumed to be linked to a central server through a backbone network. The RSSI values are brought to the server for building and storing the distributions as well as computing the location in the online phase.

In the online phase, the transmitter is placed at location  $A$  and made to transmit. Let the observed signal strength values at receivers 1 and 2 be  $S_A^1$  and  $S_A^2$  respectively. These values follow the PDFs  $f_A^1$  and  $f_A^2$  respectively. Here,  $f_A^1(S_A^1)$  and  $f_B^1(S_A^1)$  are the values of the PDFs  $f_A^1$  and  $f_B^1$  at the observed RSSI value  $S_A^1$  at receiver 1 and  $f_A^2(S_A^2)$  and  $f_B^2(S_A^2)$  are the values of the PDFs  $f_A^2$  and  $f_B^2$  at the observed RSSI value  $S_A^2$  at receiver 2.

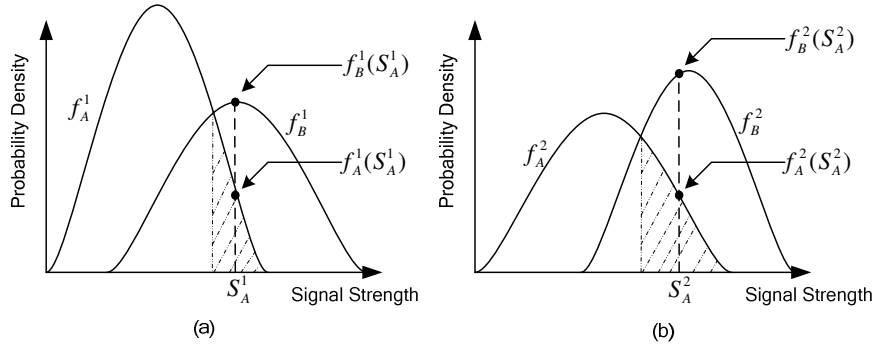

Fig. 3. Probability Density Functions of RSSI from locations A and B (a) at Receiver 1 and (b) at Receiver 2

Unlike the single receiver case, here, the product of  $f_B^1(S_A^1)$  and  $f_B^2(S_A^2)$  has to be greater than the product of  $f_A^1(S_A^1)$  and  $f_A^2(S_A^2)$  for the transmission from location A to be wrongly identified as if it is originating from location B. This probability can be represented mathematically as

$$P_2^{A \rightarrow B} = P(f_A^1(S_A^1) \cdot f_A^2(S_A^2) < f_B^1(S_A^1) \cdot f_B^2(S_A^2)) \quad (3)$$

where  $P_2^{A \rightarrow B}$  is the probability of wrongly identifying a transmission from location A as being originated from location B.

Now, the scenario is scaled to  $k$  receivers which are assumed to be linked to the central server. In the offline phase, the transmitter is placed at both of the reference locations and made to transmit for a period of time. The received RSSI values on the  $k$  receivers are brought to the central server and RSSI PDFs are computed for both reference grid locations at each receiver. These PDFs are labeled as  $f_A^i$  and  $f_B^i$  where  $i=1 \dots k$  is the receiver number and  $f_A^i$  represents the PDF of the RSSI from a

transmitter placed at location  $A$  observed at receiver  $i$  and  $f_B^i$  represents the PDF of the RSSI from a transmitter placed at location  $B$  observed at receiver  $i$ . In the online phase, the transmitter is placed at location  $A$  and made to transmit. RSSI values  $S_A^i$  are received at receivers  $i=1 \dots k$ , where  $S_A^i$  follows PDF  $f_A^i$ . By induction from (3), the probability of wrongly identifying a transmission originating from location  $A$  as if it is originating from location  $B$  can now be expressed as

$$P_k^{A \rightarrow B} = P \left( \prod_{i=1}^k f_A^i(S_A^i) < \prod_{i=1}^k f_B^i(S_A^i) \right) \quad (4)$$

where  $P_k^{A \rightarrow B}$  is the probability of wrongly identifying a transmission from location  $A$  as if it is coming from location  $B$  with  $k$  receivers in use;  $S_A^i$  is the RSSI observed at receiver  $i$  from location  $A$ ;  $f_A^i(S_A^i)$  is the value of the PDF  $f_A^i$  at the RSSI value  $S_A^i$ ; and  $f_B^i(S_A^i)$  is the value of the PDF  $f_B^i$  at the RSSI value  $S_A^i$ . Equation (4) quantifies probability of erroneous identification in a probabilistic location determination system. This equation helps in further analysis of the location error with and without spatial diversity and to understand the impact of number of receivers on the location accuracy, which are presented in subsequent sections. Next we present analytical results with our proposed scheme with spatial diversity where we demonstrate that spatial diversity enhances location accuracy and minimizes error.

## ***B. Spatial Diversity and Location Determination***

**Lemma 3.1** (*Variance Reduction with Spatial Diversity*): For an indoor transmitter and receiver location pair with Rayleigh distribution of signal strength, the variance in the signal strength distribution is reduced when the proposed selection combining approach

with highest RSSI being the criterion is employed on two uncorrelated fading envelopes, compared with using a single input source.

*Proof:* Let the PDFs of RSSI from a given transmitter location for the two uncorrelated fading channels be given by  $f_1$  and  $f_2$ , and the cumulative distribution functions (CDF) by  $F_1$  and  $F_2$ . But since the spatially diverse antennas providing the uncorrelated fading channels are closely located, we assume that these two antennas share similar probability distributions of RSSI for a given transmitter location. Hence,

$$f_1(S) = f_2(S); F_1(S) = F_2(S); \forall S \quad (5)$$

It is to be noted that though the distributions are similar, the signal strength at any given time from the distributions resulting from the antennas inputs is completely independent and uncorrelated (different) due to separation between them. At any given time  $t$ , let  $S_1(t)$  and  $S_2(t)$  represent the observed RSSI values on the two independent uncorrelated channels. By application of the proposed selection combining approach where the antenna with higher instantaneous RSSI is selected at all times, we now evolve a new RSSI parameter  $S_{select}(t)$  from the RSSI values observed on the two antennas where

$$S_{select}(t) = \max(S_1(t), S_2(t)) \quad (6)$$

Let the PDF and CDF of this resulting RSSI parameter  $S_{select}(t)$  from the proposed selection combining be given by  $f_{new}$  and  $F_{new}$  respectively. By definition of the cumulative distribution function, if  $F$  represents the CDF of a random variable  $x$ , for any value  $x_i$ ,  $F(x_i)$  represents the probability that the random variable  $x$  is less than  $x_i$ . Hence by definition, the CDF  $F_{new}(S)$  represents the probability that  $S_{select}(t)$  is less than  $S$ .

Since,  $S_{select}(t)$  is the maximum of  $S_1(t)$  and  $S_2(t)$ , it follows that both  $S_1(t)$  and  $S_2(t)$  have to be less than  $S$ . Therefore,

$$F_{new}(S) = F_1(S) \cdot F_2(S) = (F_1(S))^2 \quad (7)$$

where  $F_{new}(S)$  is the cumulative distribution function of RSSI of the new parameter from the proposed selection combining approach and  $F_1(S)$  is the CDF of RSSI on either of the input sources.

It has been shown in the literature that indoor propagation follows a Rayleigh model and results in a Rayleigh distribution of received signal strength [19]. Let us assume, therefore without loss of generality, that the RSSI distributions on the input sources follow a Rayleigh distribution with a scale factor of  $s$ . Then the cumulative distribution function [20] can be defined as

$$F_1(S) = 1 - e^{-\frac{S^2}{2s^2}} \quad (8)$$

Substituting (8) into (7) results in

$$F_{new}(S) = (F_1(S))^2 = 1 - 2e^{-\frac{S^2}{2s^2}} + e^{-\frac{S^2}{s^2}} \quad (9)$$

Differentiating (9) yields

$$f_{new}(S) = 2f_s(S) - f_{s/\sqrt{2}}(S) \quad (10)$$

where  $f_{s/\sqrt{2}}(S)$  is the PDF of the Rayleigh distribution with the scale parameter of  $s/\sqrt{2}$  and  $f_s(S)$  is the PDF of the Rayleigh distribution with a scale parameter of  $s$  which is the same as  $f_1(s)$ . The original distribution with a scale parameter of  $s$  and probability density function  $f_1(s) = f_s(s)$  has a variance of  $\sigma_1^2 = s^2 \cdot \left(2 - \frac{\pi}{2}\right) = 0.4292 \cdot s^2$  while the

probabilistic distribution of the evolved RSSI parameter from the proposed selection combining method with probability density function  $f_{new}(S) = 2f_s(S) - f_{s/\sqrt{2}}(S)$  can be shown to have variance of  $\sigma_{new}^2 = s^2 \cdot \frac{(12 + (4\sqrt{2} - 9) \cdot \pi)}{4} = 0.3743 \cdot s^2$ . Since the scale parameter of the Rayleigh distribution,  $s$ , is a real number, it is obvious that  $f_{new}(S)$  has a lower variance than  $f_1(S)$ . Thus, the proposed method of selection combining of two uncorrelated fading channels with similar signal strength probability distributions results in a lower variance with a factor of approximately 13% compared to the single branch case. ■

**Theorem 3.1** (*Improved Location Determination with Spatial Diversity*): For a given number of receivers, use of spatial diversity renders improved location accuracy for a pre-profiling based probabilistic WLAN location determination system.

Proof: Let us consider a simple location identification system again with two locations  $A$  and  $B$  and a single receiver  $i$ . Let the signal strength distributions from both locations  $A$  and  $B$  be profiled at receiver  $i$  in the offline phase as detailed in Section III A. Let these distributions have probability density functions  $f_A^i$  and  $f_B^i$ , as shown in Fig. 4. Let the mean of  $f_A^i$  be  $\mu_A^i$  and its standard deviation be  $\sigma_A^i$ . Similarly, let the mean of  $f_B^i$  be  $\mu_B^i$  and its standard deviation be  $\sigma_B^i$ . Let us initially assume  $\mu_A^i < \mu_B^i$  (The opposite case is also handled later). We define  $S(f_A^i = f_B^i)$  as the value of RSSI at which  $f_A^i(S) = f_B^i(S)$ .

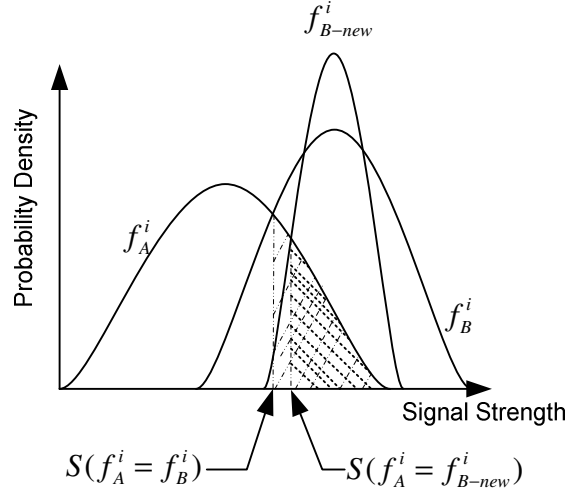

Fig. 4. Reduction in error area from spatial diversity

As derived in Section III A, the probability that a transmission from location  $A$  is wrongly identified as originating from location  $B$  using only the single receiver  $i$  in the online phase is given by the probability of obtaining an RSSI value  $S_A^i$  from location  $A$  at receiver  $i$ , for which the condition  $f_B^i(S_A^i) > f_A^i(S_A^i)$  is satisfied. It can be seen from Fig. 4 that the range of  $S_A^i$  over which  $f_B^i(S_A^i) > f_A^i(S_A^i)$  is given by  $S(f_A^i = f_B^i) < S_A^i < \infty$ . The probability of observing an RSSI value in this range at receiver  $i$  from a transmitter placed at location  $A$  is given by the integral of  $f_A^i(S)$  over this interval. The integral is given as

$$P^{A \rightarrow B} = \int_{S(f_A^i = f_B^i)}^{\infty} f_A^i(S) \cdot dS \quad (11)$$

where  $P^{A \rightarrow B}$  represents the probability of identification of a transmitter at location  $A$  as if it is at location  $B$  based on the previously recorded signal strength distributions from



locations  $A$  and  $B$  at receiver  $i$ ,  $S(f_A^i = f_B^i)$  represents the RSSI value at the receiver where the PDFs from locations  $A$  and  $B$  are equal to each other, and  $f_A^i(S)$  represents the PDF of the RSSI distribution at the receiver from location  $A$ .

Now, consider that by a suitable method (in our case, spatial diversity and the proposed selection combining approach), the variance of the signal strength distribution at the receiver  $i$  from location  $B$  is reduced to  $\sigma_{B-new}^i$  and the PDF corresponding to this distribution is  $f_{B-new}^i$  as shown in Fig. 4 where

$$\sigma_{B-new}^i < \sigma_B^i \quad (12)$$

We also define the RSSI value at which the PDF  $f_{B-new}^i$  meets  $f_A^i$  as  $S(f_A^i = f_{B-new}^i)$ .

Now,

$$S(f_A^i = f_{B-new}^i) > S(f_A^i = f_B^i) \quad (13)$$

On similar lines as in (11), the probability of wrongly identifying a transmission from location  $A$  as originating from location  $B$  can be derived as

$$P_{new}^{A \rightarrow B} = \int_{S(f_A^i = f_{B-new}^i)}^{\infty} f_A^i(S) \cdot dS \quad (14)$$

where  $P_{new}^{A \rightarrow B}$  is the probability of identification of location  $A$  as location  $B$  based on the new signal strength distribution from a transmitter at location  $B$  at receiver  $i$  with reduced variance. But, from (13) and since  $f_A^i(S)$  is always positive,

$$P_{new}^{A \rightarrow B} < P^{A \rightarrow B} . \quad (15)$$

Now consider the second case where  $\mu_1 > \mu_2$ . The error is given by

$$P^{A \rightarrow B} = \int_{-\infty}^{S(f_A^i = f_B^i)} f_A^i(S) \bullet dS \quad (16)$$

Once again, we assume that the signal strength distribution at the receiver  $i$  from location  $B$  is by suitable means (in our case, Spatial diversity), altered to  $f_{B-new}^i$  with variance  $\sigma_{B-new}^i$  where

$$\sigma_{B-new}^i < \sigma_B^i \quad (17)$$

Then it follows that

$$S(f_A^i = f_{B-new}^i) > S(f_A^i = f_B^i) \quad (18)$$

The error now becomes

$$P_{new}^{A \rightarrow B} = \int_{-\infty}^{S(f_A^i = f_{B-new}^i)} f_A^i(S) \bullet dS \quad (19)$$

But from (18) and since  $f_A^i(S)$  is always positive,  $P_{new}^{A \rightarrow B} < P^{A \rightarrow B}$ . Thus for both  $\mu_1 > \mu_2$  and  $\mu_1 < \mu_2$ , the probability of location  $A$  being wrongly identified as location  $B$  is shown to be reduced if the variance of the RSSI distribution from location  $B$  is reduced. Similarly, it can be shown that reducing the variance of  $f_A(S)$  will reduce the probability of wrongly identifying a transmission from an object at location  $B$  as originating from location  $A$ . Thus, reduction in variance of both distributions is proven to effectively reduce location determination error.

Lemma 3.1 indicates that the proposed method of selection combining of two uncorrelated input sources from application of spatial diversity reduces the variance of the received signal strength distributions. On the other hand, Theorem 3.1 shows that by

using spatial diversity, the accuracy of determining location of an asset equipped with a transmitter is enhanced. Hence, use of spatial diversity with proposed method of selection combining is shown to reduce error in location determination in signal strength based systems. ■

Next we present how increasing the number of receivers will indeed enhance the location accuracy.

### C. Number of Receivers

**Theorem 3.2** (*Location Accuracy with Number of Receivers*): For a pre-profiled signal strength based probabilistic WLAN location determination system, the location accuracy with  $k+1$  receivers is better than the location accuracy with  $k$  receivers for all  $k > 0$ .

*Proof:* Consider first the simple case of a system with two locations  $A$  and  $B$  and  $k$  receivers. As derived in (4), the probability  $P_k^{A \rightarrow B}$  of a transmission originating from a transmitter at location  $A$  being wrongly identified as originating at location  $B$  in this system with  $k$  receivers is given by

$$P_k^{A \rightarrow B} = P \left( \prod_{i=1}^k f_A^i(S_A^i) < \prod_{i=1}^k f_B^i(S_A^i) \right) \quad (20)$$

where  $f_A^i$  is the PDF of the pre-profiled RSSI distribution at receiver  $i$  from a transmitter at location  $A$  obtained in the offline phase,  $f_B^i$  is the PDF of the pre-profiled RSSI distribution at receiver  $i$  from a transmitter at location  $B$  obtained in the offline phase,  $S_A^i$  is the RSSI value received from location  $A$  at receiver  $i$  in the online phase,  $f_A^i(S_A^i)$  is the value of the probability density function  $f_A^i$  at RSSI value of  $S_A^i$ , and  $f_B^i(S_B^i)$  is the

value of the probability density function  $f_B^i$  at RSSI value of  $S_A^i$ . Now, consider adding a receiver to the system resulting in  $k+1$  receivers. The probability of a transmitter located at  $A$  being wrongly identified as at  $B$  is given by

$$P_{k+1}^{A \rightarrow B} = P \left( \prod_{i=1}^{k+1} f_A^i(S_A^i) < \prod_{i=1}^{k+1} f_B^i(S_A^i) \right) \quad (21)$$

where  $P_{k+1}^{A \rightarrow B}$  is the probability of wrongly identifying a transmission from location  $A$  as if it is coming from location  $B$  with  $k+1$  receivers in use. Let  $S_A^{k+1}$  be the observed RSSI value at receiver  $k+1$  from location  $A$  in the online phase, and thus also a random variable following the distribution with PDF  $f_A^{k+1}$ . Since  $S_A^{k+1}$  follows the distribution with PDF  $f_A^{k+1}$ , it can be proved that

$$E(f_B^{k+1}(S_A)) \leq E(f_A^{k+1}(S_A)) \quad (22)$$

From (20) through (22), it follows that

$$P_{k+1}^{A \rightarrow B} \leq P_k^{A \rightarrow B} \quad (23)$$

Hence, for a system with two locations, the probability of a location being identified wrongly as the other reduces with an increase in the number of receivers. Now, consider a system with  $l$  locations  $A_1, A_2, A_3 \dots A_l$  and  $k$  receivers. In this system, when a transmission is observed, the measured RSSI values at each receiver are conveyed to and compiled at a central server. For each reference point, the probability of the transmission having originated at that point is calculated. This probability is given by the product of individual probabilities of observing the measured RSSI values at each receiver individually when the transmitter is at the specific location. Finally, the reference point with the maximum probability is selected as the estimated location of the

transmitter. For a transmission from location  $A_i$  to be correctly identified with  $k$  receivers in the system, the estimated probability of receiving the observed set of RSSI values at the  $k$  receivers must be greater than the estimated probability of receiving them from any of the reference locations  $A_j; j \in 1, 2, \dots, l; j \neq i$ . This is mathematically given as

$$P_k^{A_i \rightarrow A_i} = \prod_{j \in 1, 2, \dots, l; j \neq i} (1 - P_k^{A_i \rightarrow A_j}) \quad (24)$$

where  $P_k^{A_i \rightarrow A_j}$  is the probability of identifying location  $A_i$  as  $A_j$  with  $k$  receivers in the system. The above equation states that the probability of correct identification is the product of complement of the probability of all possible wrong identifications.

Now, by adding a receiver to the system, the probability of correct identification becomes

$$P_{k+1}^{A_i \rightarrow A_i} = \prod_{j \in 1, 2, \dots, l; j \neq i} (1 - P_{k+1}^{A_i \rightarrow A_j}) \quad (25)$$

where  $P_{k+1}^{A_i \rightarrow A_j}$  is the probability of identifying location  $A_i$  as  $A_j$  with  $k+1$  receivers. But for any  $j; j \in 1, \dots, l, j \neq i$ ,

$$P_{k+1}^{A_i \rightarrow A_j} \leq P_k^{A_i \rightarrow A_j} \quad (26)$$

Hence

$$\prod_{j \in 1, 2, \dots, l; j \neq i} (1 - P_{k+1}^{A_i \rightarrow A_j}) > \prod_{j \in 1, 2, \dots, l; j \neq i} (1 - P_k^{A_i \rightarrow A_j}) \quad (27)$$

Therefore,

$$P_{k+1}^{A_i \rightarrow A_i} \geq P_k^{A_i \rightarrow A_i} \quad (28)$$

Hence, it is proven that the probability of a location being correctly identified improves with an increase in the number of receivers. ■

The theorems presented above show that the accuracy improves both with spatial diversity and increasing the number of receivers. Next the proposed location determination schemes are introduced, which are built upon the known schemes, deterministic and probabilistic methods, from the literature.

#### ***D. Location Determination Algorithm***

Both probabilistic and deterministic techniques from the literature are evaluated with and without spatial diversity. Further, the application of diversity and the proposed method of selection combining on top of either technique is discussed.

##### **1) Probabilistic technique**

A simplified version of HORUS [8], which is a probabilistic technique, is considered in this work. A grid is initially constructed to provide the reference points for profiling. The coordinates of these reference points on the grid are measured and recorded for mapping RSSI values to the location. The technique begins with an offline phase where the grid points are profiled for a period of time to record  $n$  samples of the signal strength value at each receiver from each of the  $l$  reference grid points. To simplify the storage problem, the signal strength values received from each of the reference grid points at each receiver are mapped to a Gaussian distribution. The mean and variance of each of these distributions is stored rather than storing all the RSSI values received at each receiver from each reference point. In other words, given  $n$  signal strength samples from location  $X$  at receiver  $i$ , the estimate for mean signal strength at receiver  $i$  from any location  $X$  is given by

$$\hat{\mu} = \frac{1}{n} \sum_{k=1}^n S_X^i(k) \quad (29)$$

where  $\hat{\mu}$  is the estimated mean of the RSSI distribution and  $S_X^i(k)$  is the  $k^{\text{th}}$  signal strength sample from location  $X$  at receiver  $i$ . The variance is estimated as

$$\hat{\sigma}^2 = \frac{1}{n} \sum_{k=1}^n [S_X^i(k) - \hat{\mu}]^2 \quad (30)$$

where  $\hat{\sigma}^2$  is the estimated variance of the RSSI distribution and  $S_X^i(k)$  is the  $k^{\text{th}}$  signal strength sample from location  $X$  at receiver  $i$ .

Actual location determination is accomplished in the online phase by using the mapping constructed from the offline phase. For each receiver, the probability of receiving the observed RSSI value from each of the reference locations is calculated using the Gaussian probability function as

$$P(S_i / x_j) = \int_{S_i - 0.5}^{S_i + 0.5} \frac{1}{\hat{\sigma}_{x_j}^i \sqrt{2\pi}} e^{-\frac{(s - \hat{\mu}_{x_j}^i)^2}{2(\hat{\sigma}_{x_j}^i)^2}} \bullet ds \quad (31)$$

where  $\hat{\mu}_{x_j}^i$  and  $\hat{\sigma}_{x_j}^i$  are the pre-profiled estimates for mean and standard deviation of received signal strength at receiver  $i$  from location  $x_j$  and  $P(S_i / x_j)$  is the probability of receiving RSSI value  $S_i$  from location  $x_j$  at receiver  $i$ . Since the XBee modules quantize the RSSI values, the PDF values are integrated over a range of RSSI values between  $-0.5$  to  $+0.5$ . The process is repeated for all  $x_j; j \in 1 \dots N$  and for all receivers  $i; i \in 1 \dots k$ . Now, the overall probability  $P(S / x_j)$  that the set of observed RSSI values at all receivers originates from a reference location  $x_j$ , is given as

$$P(S / x_j) = \prod_{i=1}^k P(S_i / x_j) \quad (32)$$

where  $S = \{S_i\}; i \in 1 \dots k$  and  $S_i$  is the observed RSSI at the  $i^{\text{th}}$  receiver.

In the end, a sorted list of the locations is generated in descending order of their probabilities. The coordinates of only the four reference locations with the highest probabilities are used in location determination. The use of four locations makes intuitive sense since any point can be enclosed by a square with four closest neighbors. The coordinates of each of these four locations are multiplied with their corresponding probabilities and a weighted averaging is performed. The result of this operation is returned as the location. This process is similar to the center-of-mass technique [24].

## **2) Deterministic technique**

The first step in the deterministic technique [7] also involves construction of a reference grid and generating coordinates of reference grid points. In the offline phase, RSSI signature vectors are collected from all reference grid points at different times in a day and during the week. These different profiles are used to arrive at the average signal strength value from each reference point on the grid at each receiver. In the online phase, a signal strength vector is constructed from the RSSI values observed from a transmitter at each of the receivers. The Euclidean distance from this vector to each of the averaged profile entries is taken. The reference points are now arranged in the order of descending Euclidean distances. The four reference points with the lowest Euclidean distance from their RSSI vectors recorded in the offline phase to the measured RSSI vector in the online phase are used in location determination. The coordinates of these four points are averaged to provide a location.

### ***E. Diversity and Combining***

There are two methods of implementing the proposed method of selection combining on top of spatial diversity using the probabilistic and deterministic schemes. It



can be implemented on the hardware level using a switch for selecting the antenna with higher RSSI and using a single receiver as shown in Fig. 5 (a). A second method of implementation would be at the software level, where signal strength values are recorded on two spatially separate receiver units and the higher RSSI value is selected while processing as shown in Fig. 5 (b). We use the latter implementation in our testbed as it is much easier to implement, but from the view of cost-effective implementation, not requiring additional processing, the former implementation is more suitable to a true real-time location determination.

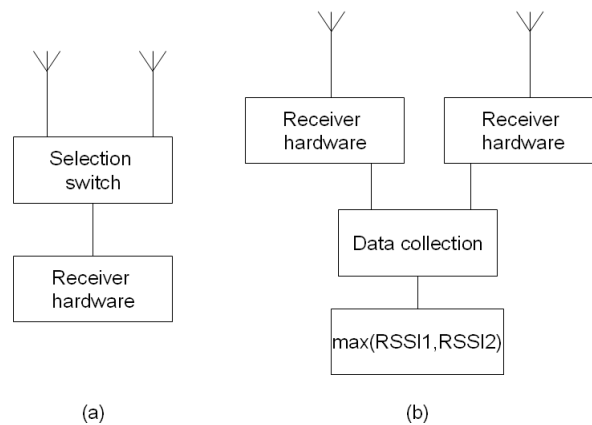

Fig. 5. (a) Hardware implementation of spatial diversity and proposed selection combining approach (b) software implementation

In location determination without using diversity, only one receiver from each pair is used in analysis, in both the online and offline phases. By contrast, in using the system with diversity applied, each pair of receivers is viewed as a single receiver. For every packet received and RSSI reported, the maximum of the two RSSI values is taken

for each pair. This software-level selection is applied before using the RSSI values for processing in both online and offline phases. Thus, the location determination algorithm becomes a higher layer of processing when the combining layer is added as shown in Fig. 6.

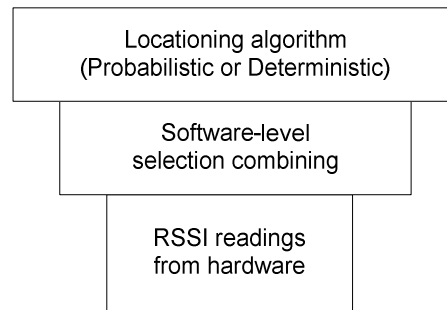

Fig. 6. Layered representation of the proposed method of selection combining

#### ***F. Tracking, Averaging and Prediction***

Detection of movement of an asset, tracking it and predicting its location are areas relevant to location determination. The first application of location tracking can be understood from [25] where a viterbi-based scheme is developed to limit unusual asset movement patterns by limiting mobility between consecutive locations in time. While such an approach will enhance the accuracy for a stationary or slow-moving asset, assets possessing considerable mobility are likely to suffer from a loss of accuracy since the system works on the basis of selecting the path that ensures least distance of travel of the tracked asset. Further, the approach does not detect whether the asset is in motion or not.

Location determination based on signal strength results in scattering of estimated locations around a small area over time. Over a small interval of time, such random scattering may exhibit directivity in motion. Using a small time window to observe estimated location coordinate variations of a stationary asset to detect directed motion may lead to misinterpreting asset movement status as moving. Increasing the observation window size to a large value will improve detection accuracy but will cause a sluggish response in the motion detection algorithm. To solve this problem, we introduce a two-level system of observation and averaging. Estimated motion trends over multiple consecutive, yet overlapping observation windows are averaged. This process, while eliminating the sluggishness of response, ensures sufficient certainty in determining movement status. The proposed algorithm is introduced as follows.

In the motion detection algorithm, cumulative motion in either the  $x$  or  $y$  direction is observed for determining movement status. RSSI values are obtained from the asset every second and location determination is carried out using either the probabilistic or deterministic method with or without applying diversity. Only continuous cumulative directed motion in the  $x$  or  $y$  direction or both is treated as motion. At the observing level, a window size of  $n$  is employed and at the averaging level, the window is of size  $m$ . The mobile transmitter is made to transmit once every second, resulting in one set of located coordinates every second. A buffer of the last  $n$  sets of estimated location coordinates is maintained in the system. The  $x$  and  $y$  coordinate variation between each pair of consecutive locations in this buffer is added up over all  $n-1$  intervals between the  $n$  locations. Mathematically, at time  $t$ , these summed values can be evaluated as

$$\Delta x_n(t) = (x(t) - x(t-n+1)) \quad (33)$$

where  $x(t)$  is the located  $x$  coordinate at time  $t$  and  $x(t-n+1)$  is the located  $x$  coordinate at time  $t-n+1$ . Similarly,

$$\Delta y_n(t) = (y(t) - y(t-n+1)) \quad (34)$$

where  $y(t)$  is the located  $y$  coordinate at time  $t$  and  $y(t-n+1)$  is the located  $y$  coordinate at time  $t-n+1$ . This completes the lower level moving window average. Now, for the next level, the last  $m$  calculated values of  $\Delta x_n$  and  $\Delta y_n$  are stored in a second buffer. The mean values from these buffers provide the motion trend variables  $mean\_ \Delta x$  and  $mean\_ \Delta y$  for the system. These are formulated as

$$mean\_ \Delta x = \frac{1}{m} \sum_{i=t-m+1}^t \Delta x_n(i) \quad (35)$$

where  $mean\_ \Delta x$  is the estimated trend for the  $x$  coordinate variation over  $n-1$  time intervals. Similarly,

$$mean\_ \Delta y = \frac{1}{m} \sum_{i=t-m+1}^t \Delta y_n(i) \quad (36)$$

where  $mean\_ \Delta y$  is the trend for the  $y$  coordinate variation over  $n-1$  time intervals. The resultant total movement from the trended  $x$  and  $y$  is calculated as the square root of the sum of squares of the two trend values. If this value is above a given threshold, it indicates continuous cumulative directed motion of the tracked asset in a certain direction. Hence, we determine that the asset is moving. If the total trended movement is below the threshold, the asset is declared stationary. This status reporting is based on the current and previous  $m+n-2$  estimated location coordinates and hence results in a delay

of  $\frac{m+n}{2}-1$  time units in motion status reporting. In the system under test, we use a value of 10 for both  $n$  and  $m$ . This value results in substantially sized averaging windows at both levels while not resulting in a huge delay in reporting the movement status of the asset. For example, a value of 10 for both  $n$  and  $m$  would result in a delay of nine time units (seconds) in reporting the movement status, while using a value of 15 for both  $n$  and  $m$  would result in a delay of fourteen time units (seconds). Further, a higher averaging window size results in a sluggish response in the motion detection algorithm when the state of the asset changes from moving to stationary or vice versa. Thus a trend of  $x$  and  $y$  direction movement of the asset over nine ( $n-1$ ) time intervals is obtained as  $mean\_Δx$  and  $mean\_Δy$ , respectively. The process is detailed in Fig. 7.

A similar method is developed for averaging located coordinates to improve accuracy. Once again, an averaging system of small window size will not provide sufficient accuracy while a large averaging window will enhance accuracy, but result in sluggish response in updating the location when the tracked asset moves. To both improve accuracy and location update response time, we devise a lower averaging level to remove the small-time-scale scattering of located coordinates, and perform further averaging of the resulting averaged coordinates to enhance accuracy while ensuring a quick system update when the asset location changes. Here,  $n$  and  $m$  are used as window sizes for two levels of moving window averaging. In the first moving window, at any given time, the set of current estimated location coordinates as well as the  $n-1$  previous located coordinates are averaged. This averaging process is mathematically depicted as

$$x_{mean}(t) = \frac{1}{n} \sum_{i=t-n+1}^t x(i) \quad (37)$$

where  $x_{mean}(t)$  is the mean of the current and last  $n-1$  located  $x$  coordinate values, and  $x(i)$  is the located  $x$  coordinate value at time  $t = i$ .

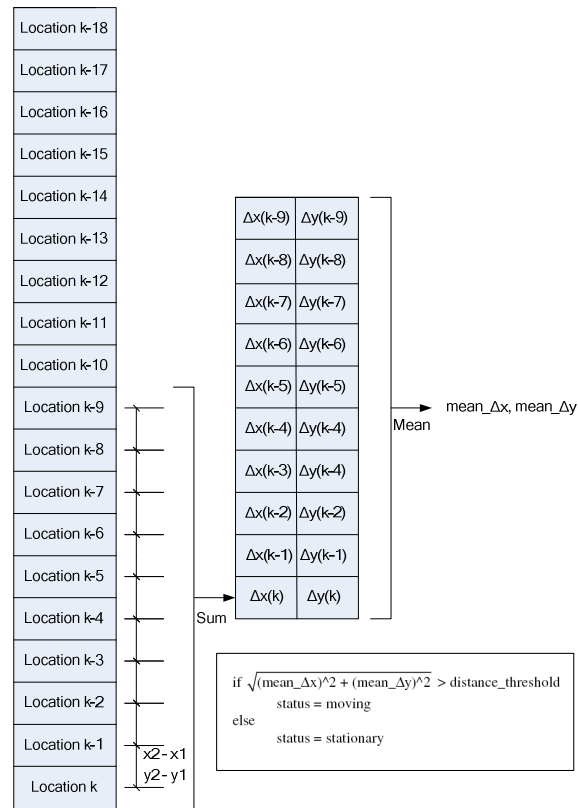

Fig. 7. Calculation of averaged cumulative  $x$  and  $y$  motion for nine time units

Similarly,

$$y_{mean}(t) = \frac{1}{n} \sum_{i=t-n+1}^t y(i) \quad (38)$$

where  $y_{mean}(t)$  is the mean of the current and last  $n-1$  located  $y$  coordinate values, and  $y(i)$  is the located  $y$  coordinate value at time  $t=i$ . In the higher level moving window average, the mean of the current and previous  $m-1$  averaged  $x$  and  $y$  coordinate values is used as the estimated location. This secondary level of averaging is given as

$$mean\_x = \frac{1}{m} \sum_{i=t-m+1}^t x_{mean}(i) \quad (39)$$

where  $mean\_x$  is the averaged location  $x$  coordinate resulting as a function of  $x$  coordinate values from the current and previous  $m+n-2$  location estimates. Similarly,

$$mean\_y = \frac{1}{m} \sum_{i=t-m+1}^t y_{mean}(i) \quad (40)$$

where  $mean\_y$  is the averaged location  $y$  coordinate resulting as a function of  $y$  coordinate values from current and previous  $m+n-2$  locates. Thus, the reported location suffers a time lag of  $\frac{m+n}{2}-1$  time units from the current location in location reporting, thus offering improved accuracy at the cost of delayed location reporting. In the system under test, parameters  $m$  and  $n$  are set to 10, resulting in a nine time unit delay in location reporting. The averaging is detailed in Fig. 8.

The reported trend variables  $mean\_Δx$  and  $mean\_Δy$  represent the expected movement in the  $x$  and  $y$  directions from the averaged location estimate over a period of  $n-1$  seconds. To calculate the current location from the averaged location with a delay of  $\frac{m+n}{2}-1$  seconds, we assume linear motion of the asset and proportionately scale the  $x$  and  $y$  movement trend values to account for  $x$  and  $y$  motion over  $\frac{m+n}{2}-1$

time units. Thus, adding these scaled trend values directly to the averaged location allows an estimation of the current position of the asset with a higher level of accuracy. Thus, the current position is predicted based on the averaged location estimate as

$$asset\_location(t) = [mean\_x + \frac{\frac{m+n}{2} - 1}{n-1} \bullet mean\_Δx, mean\_y + \frac{\frac{m+n}{2} - 1}{n-1} \bullet mean\_Δy] \quad (41)$$

where  $asset\_location(t)$  represents the estimate of the position of the asset at time  $t$ ,

$mean\_x$  and  $mean\_y$  represent the located coordinates of the asset at time  $t - \frac{m+n}{2} + 1$

based on averaging, and  $mean\_Δx$  and  $mean\_Δy$  are the expected trend values in asset movement for a period of  $n-1$  time units.

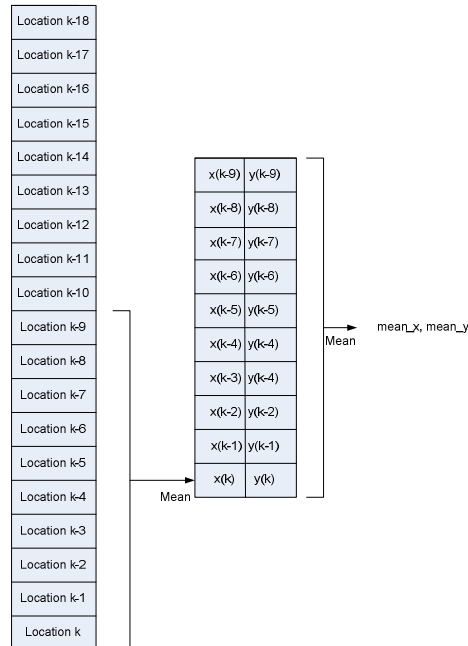

Fig. 8. Averaging of located coordinates to report position (lag of 9 units)



By similar linear scaling and assumption of linear asset movement, a trend value can be developed for more than  $\frac{m+n}{2}-1$  seconds. Let us assume that we intend to predict the asset location  $k$  time units into the future. This prediction requires an estimation of the asset movement for a time period of  $\frac{m+n}{2}+k-1$  time units from the averaged estimate since it suffers a lag of  $\frac{m+n}{2}-1$  units. Thus, the  $x$  and  $y$  movement

trends are scaled by a factor of  $\frac{\frac{m+n}{2}+k-1}{n-1}$  for this prediction. Thus, the position of the asset  $k$  time units into the future is given as

$$asset\_location(t+k) = [mean\_x + \frac{\left(\frac{m+n}{2}+k-1\right) \bullet mean\_Δx}{n-1}, mean\_y + \frac{\left(\frac{m+n}{2}+k-1\right) \bullet mean\_Δy}{n-1}] \quad (42)$$

where  $asset\_location(t+k)$  is the estimated location of the asset  $k$  time units into the future. For demonstration, in the system under consideration, we predict the asset location one time unit into the future. This implies a scaling factor

of  $\frac{\frac{m+n}{2}+k-1}{n-1} = \frac{\frac{10+10}{2}+1-1}{10-1} = \frac{10}{9}$ . Using this scaling factor and assuming linear

motion of the asset, the asset location one second into the future is estimated as

$$asset\_location(t+1) = [mean\_x + \frac{10 \bullet mean\_Δx}{9}, mean\_y + \frac{10 \bullet mean\_Δy}{9}] \quad (43)$$

where  $asset\_location(t+1)$  is the estimated location of the asset one time unit into the future (time  $t+1$ ),  $mean\_x$  and  $mean\_y$  represent the located coordinates of the asset

based on averaging at time  $t-9$  and  $\frac{10 \bullet mean\_Δx}{9}$  and  $\frac{10 \bullet mean\_Δy}{9}$  are the scaled

trend values in asset movement in the  $x$  and  $y$  directions, respectively, for a period of ten time units. The advantages of such a prediction are several. One of the possible applications is enhancement of network performance by optimizing access point handovers based on estimated future position.

Accuracy of the motion detection, tracking and prediction schemes are discussed in Section IV for stationary and moving targets for probabilistic and deterministic methods with and without applying spatial diversity.

## IV. EXPERIMENTAL RESULTS AND ANALYSIS

### A. *Testbed and Implementation*

G4-SSN motes developed at UMR, shown in Fig. 9, were used for testing. They have been used in prior work relating to wireless sensor networks [21], [22]. The wireless networking medium chosen was IEEE 802.15.4 PHY. All nodes are equipped with XBee pro radios from Maxstream [23] with 18 dBm of transmit power. To generate spatial diversity, two motes were placed at a distance of 25 cm ( $2\lambda$ ) from each other, as shown in Fig. 10.

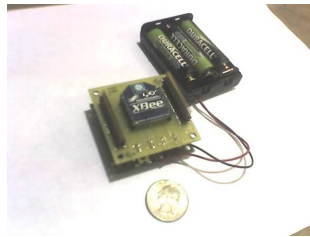

Fig. 9. UMR G4-SSN embedded wireless sensor networking platform



Fig. 10. UMR-SLU G4-SSN motes arranged for creating spatial diversity with a separation of 25 cms

Two floors of the Engineering Research Laboratory (ERL) building were used for the purpose of testing location accuracy. Only corridors were used in the evaluation. A total of 133 points were marked as reference grid points in a total area of 3624 sq. ft. of corridor area. Further, 44 test points are marked as off-grid points for accuracy evaluation. The offline training phase for both deterministic and probabilistic methods involve profiling from the 133 reference grid points. For testing on-grid accuracy, transmissions from the reference grid points themselves are tracked by using both methods. For testing off-grid accuracy, transmissions from the 44 off-grid test points are attempted to be located. Five spatially separated pairs of receivers are used for spatial diversity implementation, two on the third floor and three on the second floor. The floor plans of the ERL are given in Fig. 11 and Fig. 12 and the positions of the receiver pairs are marked with circled squares



Fig. 11. Floor plan of ERL third floor. Receiver pair positions are marked with circled squares



The pseudocode for deterministic location determination is given in Table II.

Table II : Pseudocode for deterministic location determination

---

```

RSSI Signature vector received
for all reference points, do
    Calculate Euclidean distance between profiled average
    SS vector and received RSS vector
end for
Sort list of points in ascending order of Euclidean distance
Return mean of coordinates of best four reference points
end

```

---

### ***C. Asset Location Tracking and Averaging***

For evaluating the location tracking and averaging system, a continuous path is set up on the second floor of ERL, including 96 points each 27 inches apart from the previous point. The transmitter is allowed to move along this path and made to transmit at the marked points. The received readings are assumed to be one second apart resulting in a velocity of 27 inches per second along the corridor, which is approximately half the average pace of human walking. The averaging, tracking and prediction algorithms are executed on the obtained consecutive location coordinates. The accuracy results are discussed next.

#### ***D. Results and Analysis***

Now the results are given followed by the analysis.

##### **1) Spatial diversity and location determination accuracy**

Hardware results are classified into two scenarios based on the application of probabilistic and deterministic techniques. Each of these is classified into offgrid and ongrid results. The mean accuracy in each case is plotted against the number of receivers used in the analysis. Accuracy with and without applying the diversity technique is compared. In each case, the cumulative distribution function of the location error is also presented with and without applying diversity. Finally, four sample offgrid points from the testing are taken and determined locations in each case are provided. A summary table is also included providing mean, median, and 90<sup>th</sup> percentile accuracy levels for each case. Finally, the two techniques are compared; and improvement in accuracy due to introduction of spatial diversity is demonstrated.

It can be seen from Fig. 13 (a) that use of spatial diversity with proposed selecting combining performs better than without diversity. The improvement in accuracy with diversity during the worst error case is very significant. Fig. 13 (b) shows that the improvement from the use of diversity is consistent irrespective of the number of receivers in use. Further, accuracy improves with the number of receivers used, from 127 inches to 93 inches and from 97 inches to 63 inches in the single branch case and the spatial diversity case, respectively.

Similar investigation for ongrid points shows improvement in location error from 15 inches to 7 inches in case of spatial diversity, and from 30 inches to 10 inches for the single branch case.

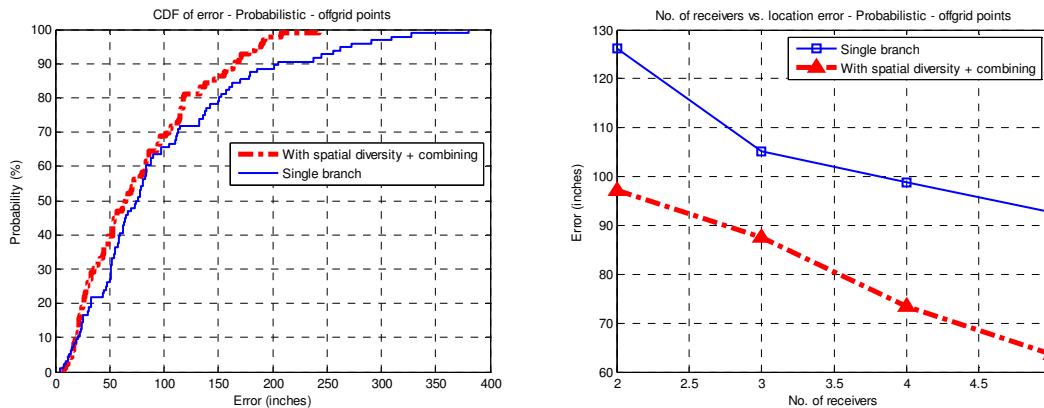

Fig. 13. Probabilistic technique- offgrid points - (a) cumulative distribution function of location error (b) location error as a function of number of receivers

On grid points should have better accuracy as they are used for profiling compared to an offgrid point. Fig. 14 (a) shows the improvement of spatial diversity with location accuracy. A consistent reduction in error is observed with both ongrid cases and with an increase in number of receivers as depicted in Fig. 14 (b).

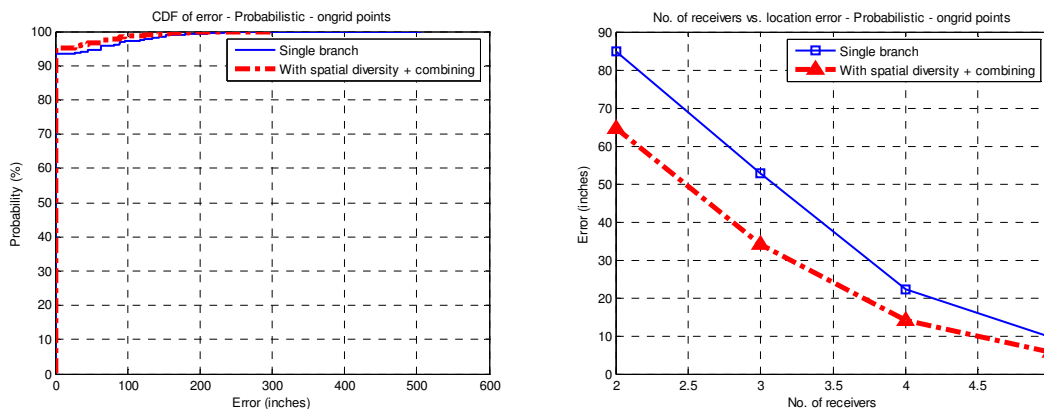

Fig. 14. Probabilistic technique, ongrid points - (a) cumulative distribution function of location error (b) location error as a function of number of receivers



Now, we analyze the deterministic method, starting with the offgrid points. Fig. 15 (a) shows significant improvement in location error which is even more noticeable at worst case scenarios. Worst case errors with and without diversity are 200 and 500 inches respectively indicating a 60% reduction. Fig. 15 (b) presents the reduction in mean error with number of receivers and with and without diversity. The difference in error after the application of spatial diversity is even more significant with number of receivers used. For instance, with five receivers in the system, the mean errors are 87 and 60 inches, respectively, without and with spatial diversity.

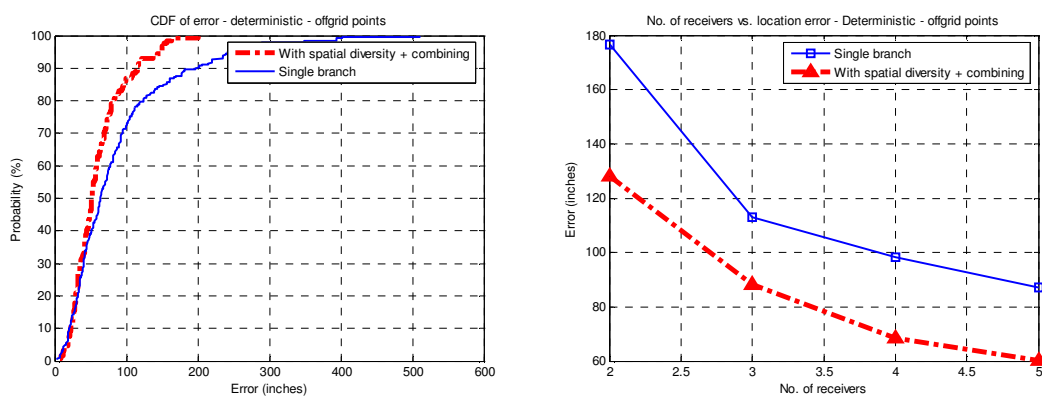

Fig. 15. Deterministic technique, offgrid points - (a) cumulative distribution function of location error (b) location error as a function of number of receivers

Fig.16 depicts this analysis for on grid points. Improvement in the CDF is still present but not as noticeable, due to the fact that only temporal variations cause error in the case of on-grid testing. Further, Fig.16 (b) depicts that mean error improves with the number of receivers regardless of whether spatial diversity is applied or not. With five

receivers, the mean errors are 85 and 57 inches, respectively, without and with spatial diversity, displaying similar levels of accuracy for on and off grid points for deterministic profiling. This shows that the deterministic technique is scalable and more resilient to small-scale effects than the probabilistic technique. Improvement due to spatial diversity is clearly seen.

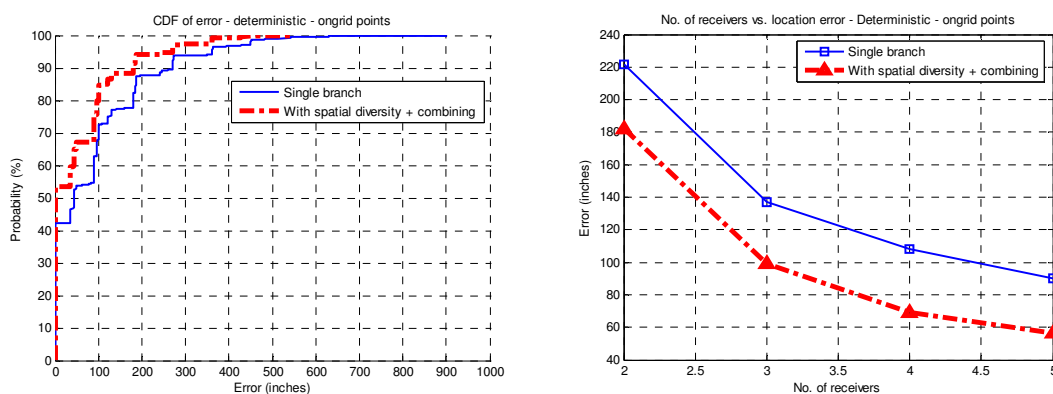

Fig.16. Deterministic technique, ongrid points - (a) cumulative distribution function of location error (b) location error as a function of number of receivers

Table III presents location results for four points. From the table, it can be seen that the use of diversity results in a closer location estimate every time. Table IV presents the summary of accuracy levels in all cases. Mean, median, and 90<sup>th</sup> percentile levels of location error are presented. In general, error levels are reduced by 30% to 40%. Worst case error levels show that better improvement can be seen from the CDF plots. Further, comparing the computational complexity, there is no improvement in accuracy resulting from the application of the probabilistic method over the deterministic technique.

Table III : Performance comparison with and without spatial diversity and number of receivers

	Point 1		Point 2		Point 3		Point 4	
	x	y	x	y	x	y	x	y
<b>True coordinates</b>	<b>1121.5</b>	<b>366.1</b>	<b>1152.5</b>	<b>451.1</b>	<b>199.4</b>	<b>748.1</b>	<b>1121.7</b>	<b>633.0</b>
Probabilistic single branch	1147.2	548.0	1137.4	150.7	232.4	726.9	1123.5	465.6
<b>Probabilistic spatial diversity</b>	<b>1134.3</b>	<b>321.8</b>	<b>1152.3</b>	<b>386.3</b>	<b>233.3</b>	<b>745.2</b>	<b>1130.1</b>	<b>531.1</b>
Deterministic single branch	1149.2	336.0	1155.1	493.3	240.3	737.6	1134.8	490.3
<b>Deterministic spatial diversity</b>	<b>1145.2</b>	<b>340.6</b>	<b>1148.0</b>	<b>491.4</b>	<b>204.2</b>	<b>730.7</b>	<b>1144.7</b>	<b>543.7</b>

Table IV: Summary of location determination error levels

	Mean error (inches)		Median Error (inches)		90 <sup>th</sup> percentile error (inches)	
	Single Branch	Spatial Diversity	Single Branch	Spatial Diversity	Single Branch	Spatial Diversity
Probabilistic on-grid	15.2	<b>7.30</b>	0.00	<b>0.00</b>	0.00	<b>0.00</b>
Probabilistic off-grid	93.2	<b>63.4</b>	73.9	<b>64.20</b>	205.31	<b>165.73</b>
Deterministic on-grid	90.33	<b>56.32</b>	45.00	<b>0.00</b>	270.00	<b>180.00</b>
Deterministic off-grid	87.20	<b>60.30</b>	64.20	<b>52.50</b>	200.40	<b>116.20</b>

## 2) Comparison of HORUS vs. spatial diversity

In comparing HORUS [8] to the method including spatial diversity, only the most simplified form of HORUS is used. This includes the part of building the radio map based on recording the signal strength distributions at each receiver from each reference location as a Gaussian distribution and using these in the online phase to locate assets. The HORUS method consists of several other modules, which can be applied to the location determination system to improve accuracy, independent and irrespective of the use of spatial diversity,. Spatial diversity in the present work investigates exactly same concerns addressed by the perturbation method [11] for mitigating small-scale factors. In comparing this method with the proposed work, it is worth mentioning that while perturbation is a software level solution to small – scale compensation, our method is a hardware-level solution. Implemented with multiple antennas and selection switching, the diversity technique would add only very minimal cost to the system.

In terms of cost, the perturbation technique [11] appears to increase computational complexity by a factor ranging from 100% to 300 % or more, depending on how many access points are perturbed and results in approximately 20 – 25 % reduction in location determination error as compared to a 35% to 40% reduction in location error brought about by the proposed diversity technique. Ignoring the hardware or software cost in implementing the methods, a direct comparison of the proposed work with the perturbation technique shows that while spatial diversity is analytically shown to improve location determination accuracy by combating multipath fading, the cause of both small-scale and temporal variations, the perturbation technique is a heuristic technique that does not take radio communication physics into account.

While use of spatial diversity attempts to effectively reduce the effect of fading on signal strength and makes the RSSI more a representative function of location, the perturbation technique in [11] attempts to fix a percentage value for perturbation based on observed improvement in performance. Thus, whether the additional cost in terms of hardware or processing is taken into account or not, the proposed work exploiting spatial diversity outperforms the perturbation technique on all counts. In addition, expanding the idea of diversity to selecting channels, frequency diversity may allow a similar level of improvement in location accuracy without any increase in hardware or processing cost.

### **3) Location tracking, averaging and prediction**

The motion detection algorithm works extremely well and it is able to detect moving assets 99% of the time. After testing with a stationary asset, the algorithm reports a false alarm of only 3%. The technique is tested with both probabilistic and deterministic techniques, with and without applying diversity. The results are shown in Fig. 17.

Further, we evaluate the accuracy of the averaged location, the estimate of the current location, and the predicted location one second into the future. It is seen that for a mobile asset, the accuracy of the averaged coordinate is much better than the calculated location based on a single set of RSSI values. Even the estimate of current location based on averaging and motion trending appears to be better than the single set RSSI locations. The predicted location one second into the future is on the average not as accurate as the single set RSSI location, but considering that this is a prediction, the values are reasonable. In the case of the stationary node, none of the schemes result in significant improvement in accuracy. No loss in accuracy is noticed as well. The mean accuracy levels in inches are shown in Fig. 18 and Fig. 19.

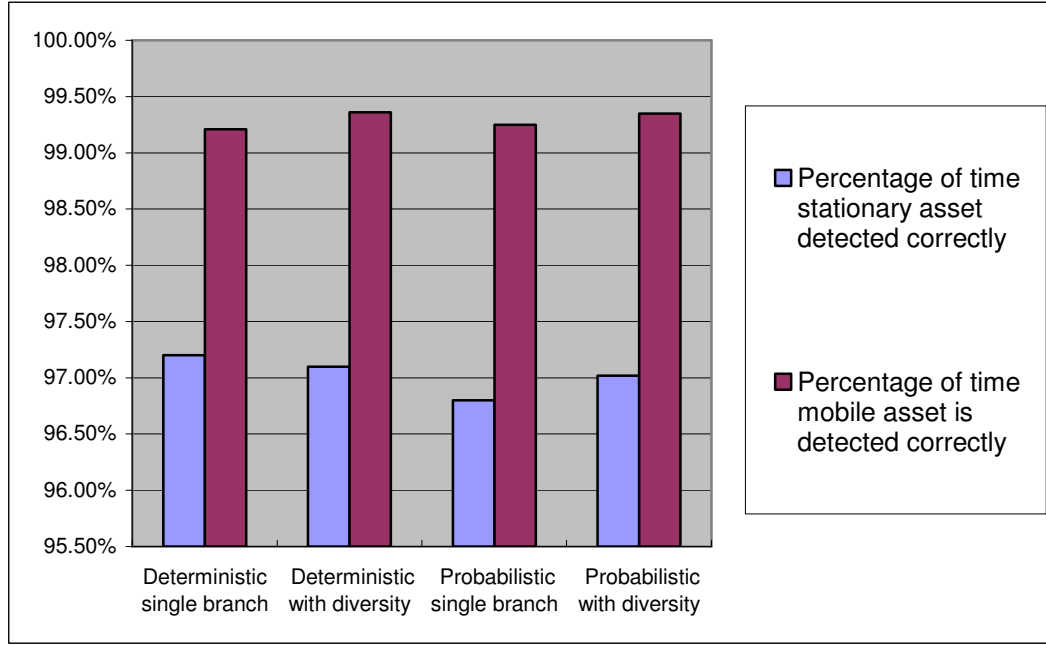

Fig. 17. Successful detection of mobile and stationary assets

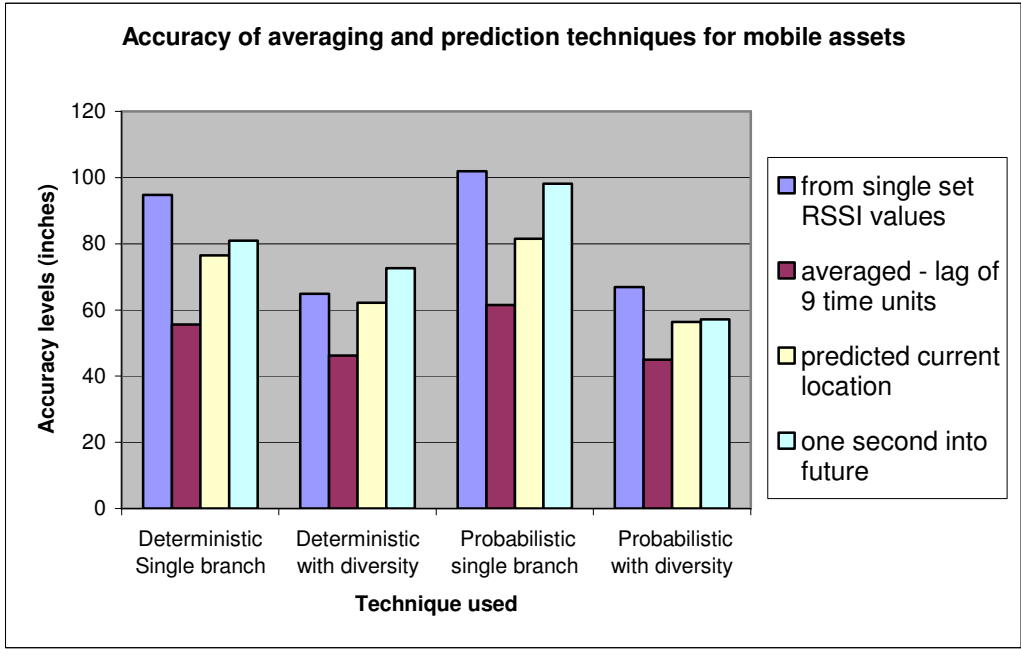

Fig. 18. Accuracy levels of averaging and prediction techniques for mobile assets

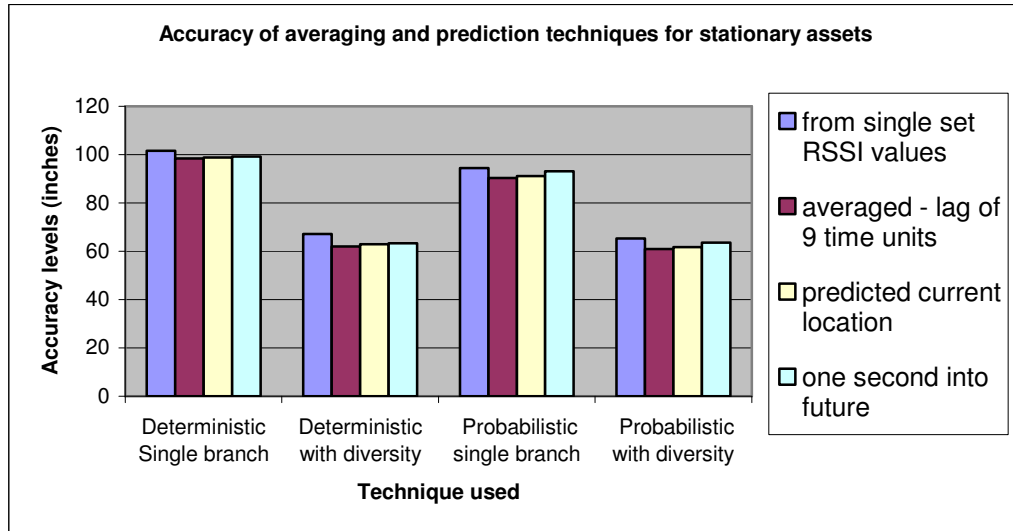

Fig. 19. Accuracy levels of averaging and prediction techniques for stationary nodes

## V. CONCLUSIONS

It is observed that spatial diversity using the proposed method of selection combining is effective in improving accuracy in both probabilistic and deterministic location determination schemes. A novel method of improving location accuracy at minimal additional hardware cost and no additional processing has been presented and demonstrated. Comparing against the increase in the number of location sensors, which resulted in improved accuracy, the use of spatial diversity is suggested to affect drastic improvements in accuracy without significantly increasing the cost of the system when the number of sensors is increased. Motion detection, averaging, and prediction techniques are developed and implemented. Substantial accuracy improvements are seen to result from addition of these methods as well, over and above the improvements from spatial diversity. In fact, improvement of 30 – 40% in average location error is noticed.

Further work would involve investigation of using frequency diversity instead of spatial diversity in reducing the effect of small scale and temporal variations in signal strength on location determination accuracy.

## REFERENCES

- [1] Priyantha, N. B., Chakraborty, A., and Balakrishnan, H. 2000. "The Cricket location-support system," *Proceedings of the 6th Annual international Conference on Mobile Computing and Networking* (Boston, Massachusetts, United States, August 06 - 11, 2000). MobiCom '00. ACM Press, New York, NY, 32-43.
- [2] Want, R., Hopper, A., Falcão, V., and Gibbons, J. 1992. "The active badge location system," *ACM Trans Inf. Syst.* 10, 1 (January 1992), 91-102.



- [3] Hightower, J., and Borriello, G. "Location systems for ubiquitous computing," *Computer*, vol.34, no.8pp.57-66, August 2001.
- [4] Zeimpekis, V., Giaglis, G. M., and Lekakos, G. 2002. "A taxonomy of indoor and outdoor positioning techniques for mobile location services", *SIGecom Exch.* 3, 4 (December 2002), 19-27.
- [5] Li, X., and Pahlavan, K., "Super-resolution TOA estimation with diversity for indoor geolocation," *IEEE Transactions on Wireless Communications*, vol.3, no.1pp. 224- 234, January 2004.
- [6] Caffery, J.J., and Stuber, G.L. "Overview of radiolocation in CDMA cellular systems," *IEEE Communications Magazine*, vol.36, no.4pp.38-45, April 1998.
- [7] Bahl, P., and Padmanabhan, V.N., "RADAR: an in-building RF-based user location and tracking system", *Proceedings of the IEEE Nineteenth Annual Joint Conference of Computer and Communications Societies, INFOCOM 2000*, vol.2, pp.775-784, 2000.
- [8] Youssef, M., and Agrawala, A. "The Horus WLAN location determination system," *Proceedings of the 3rd international Conference on Mobile Systems, Applications, and Services* (Seattle, Washington, June 06 - 08, 2005). *MobiSys '05*. ACM Press, New York, NY, 205-218.
- [9] Ganu, S., Krishnakumar, A.S., and Krishnan, P., "Infrastructure-based location estimation in WLAN," *Proc. of the Wireless Communications and Networking Conference, WCNC*, vol.1, no.pp. 465- 470 vol.1, 21-25 March 2004.

- [10] Kaemarungsi, K.; Krishnamurthy, P. "Properties of indoor received signal strength for WLAN location fingerprinting," *Proc. of the First Annual International Conference on Mobile and Ubiquitous Systems: Networking and Services, (MOBIQUITOUS 2004)*, vol., no.pp. 14- 23, 22-26 August 2004
- [11] Youssef, M., and Agrawala, A. "Small-scale compensation for WLAN location determination systems," *Proc. of the IEEE Wireless Communications and Networking, 2003. WCNC 2003*, , vol.3, no.pp. 1974- 1978 vol.3, 16-20 March 2003.
- [12] Aeroscout Enterprise Visibility Solutions., "<http://www.aeroscout.com>"
- [13] Eng, T., Ning, K., Milstein, L.B. "Comparison of diversity combining techniques for Rayleigh-fading channels," *IEEE Transactions on Communications*, vol.44, no.9, pp.1117-1129, September 1996.
- [14] Youssef, M., and Agrawala, A. "On the Optimality of WLAN Location Determination Systems", *Technical Report UMIACS-TR 2003-29 and CS-TR 4459*, University of Maryland, College Park, March 2003.
- [15] Parsons, J.D., Henze, M., Ratliff, P.A., and Withers, M.J. "Diversity techniques for mobile radio reception," *IEEE Transactions on Vehicular Technology*, vol.25, no.3pp. 75- 85, Aug 1976.
- [16] Clarke, R.H. "A statistical theory of mobile radio reception," *Journal of Bell Syst. Tech.*, vol. 47, no. 6, pp. 957-1000, July-August 1968
- [17] Watson, G. N. "A Treatise on the Theory of Bessel Functions," Cambridge University, London, 1966.

- [18] Corazza, G.E., Degli-Esposti, V., Frullone, M., Riva, G. "A characterization of indoor space and frequency diversity by ray-tracing modeling," , *IEEE Journal on Selected Areas in Communications*, vol.14, no.3pp.411-419, April 1996
- [19] Saleh, A., Valenzuela, R. "A Statistical Model for Indoor Multipath Propagation," *IEEE Journal on Selected Areas in Communications*, vol.5, no.2, pp. 128- 137, February 1987
- [20] Hayter, A.J. *Probability and Statistics for Engineers and Scientists*, PWS Publishing Company, Boston, 1996.
- [21] Fonda, J., Zawodniok, M., Jagannathan, S., and Watkins, S.E. "Adaptive Distributed Fair Scheduling and Its Implementation in Wireless Sensor Networks," *Proc. of the IEEE International Conference on Systems, Man, and Cybernetics*, pp. 3382-3387, October 2006.
- [22] Fonda, J., Zawodniok, M., Jagannathan, S., and Watkins, S.E., "Development and Implementation of Optimized Energy-Delay Sub-network Routing Protocol for Wireless Sensor Networks," *Proc. of the IEEE International Symposium on Intelligent Control*, pp. 119-124, October 2006.
- [23] Maxstream XBee and XBee pro OEM RF modules. <http://www.maxstream.net>.
- [24] Youssef, M., and Agrawala, A. "Continuous space estimation for WLAN location determination systems," *Proceedings of the 13th International Conference on Computer Communications and Networks, 2004. ICCCN 200.*, vol., pp. 161- 166, 11-13 October. 2004.

- [25] Bahl, P., Balachandran, A., Padmanabhan, V. N. "Enhancements to the RADAR User Location and Tracking System," *Microsoft Research Technical Report*, February 2000.

**PAPER 2****Use of Frequency Diversity in Signal Strength Based WLAN Location Determination Systems<sup>2</sup>**

Anil Ramachandran and S. Jagannathan\*  
Embedded Systems and Networking Laboratory  
Department of Electrical and Computer Engineering  
University of Missouri-Rolla

**ABSTRACT**— The literature indicates that frequency diversity can be utilized to compensate channel uncertainties such as multipath fading. Therefore, in this paper it is exploited for improving accuracy in locating stationary and mobile objects in the indoor environment. First, the frequency diversity technique is introduced for small scale and temporal variation compensation of received signals and it is demonstrated analytically to enhance location accuracy. A novel metric is introduced in selection combining in order to achieve location accuracy through the addition of frequency diversity upon two of the available location determination schemes. The results are evaluated experimentally against the case where there is no frequency diversity for reception by using low cost wireless RF devices such as motes. An asset location tracking system is then devised to both improve accuracy and predict asset movement. Frequency diversity in terms of channel spacing of 55 MHz is evaluated and shown to provide a reduction in location determination error between 18% and 23% when compared to a system without frequency diversity. Finally, results from frequency diversity are compared against the spatial diversity technique in terms of improvement in location accuracy, transmitter power consumption, and hardware and software costs.

**Key words**—Indoor Geo-location, WLAN Location Determination, Frequency Diversity, Location Accuracy.

---

<sup>2</sup> Research supported in part by Air Force Research Laboratory Grant (FA8650-04-C-704).

## I. INTRODUCTION

In manufacturing and service sectors, locating and tracking of assets and personnel in real-time is an area of great interest. Such technology would result in huge cost savings in terms of faster searching as well as allowing monitoring of operation time cycles. Several technologies have been developed and implemented with varying degrees of success. Initial efforts with ultrasound and infrared based techniques [1] [2] were recognized to be inferior to radio frequency (RF) technologies [3], [4], which are easily scalable and deployable. Further, low cost and minimal safety concerns due to absence of wiring also make RF technologies the preferred platform for developing locating systems. Subsequently, different location determination schemes in the RF domain were developed, which include time of arrival (TOA), time difference of arrival (TDOA), angle of arrival (AOA), and received signal strength (RSSI) etc. [5], [6].

Most indoor environments are now equipped with built-in RF networks for communication and networking applications and therefore it would be advantageous to utilize the same networks for location determination on the manufacturing shop floor, buildings, and other places. On such pre-existing RF hardware, it is difficult to build time and angle based systems for location determination owing to requirement for specialized hardware. Signal strength based systems, on the other hand, can be used on all RF networks without additional hardware and therefore are being addressed by many researchers as a cost effective solution for location determination.

The basis of signal strength-based location determination is that received signal strength indicator (RSSI) at a receiver is a function of the location of the transmitter and thus can be used to identify the location of assets equipped with a transmitter.

Consequently, for the past few years, RSSI based location determination has generated considerable interest. RSSI-based location determination systems are classified into infrastructure and client based systems depending upon where the location determination algorithm resides and executes. In a client-based system, the tracked object is equipped with a receiver and measures signal strength received from various access points and using the resident algorithm, performs location determination. RADAR and HORUS are examples of the client based system. RADAR was developed as a deterministic location determination system based on average signal strength received from each reference location [7]. On the other hand, HORUS [8] uses a probabilistic algorithm for location determination.

It is important to notice that, in the client-based location determination system, each tracked object computes its own location. While this option has the advantage of distributed computation, each tracked object platform must have sufficient computational power to identify its location. This might be difficult to implement in power constrained devices such as active RTLS tags that are normally being used for indoor location determination environments, for instance, on the manufacturing shop floor. In addition, the requirements on prior storage are also large. Another issue is that it is difficult to make location information on all assets available in a centrally available interface. There is also a security issue in allowing each device to find its own location since each device would then be aware of coordinates of the area and the radio map.

By contrast, in infrastructure-based location determination, the location determination algorithm resides on a central server to which the asset tags / mobile units either report the received signal strength vectors or they act as transmitters and their

received signal strength from them are recorded at sniffers placed around the area and reported to the server. Location computation is performed here and made accessible globally. This option enables power constrained transmitter tags to remain in very-low-power standby modes and transmit their information periodically. Such an infrastructure-based system is addressed in [9].

The work in this paper refers to an infrastructure based system because the current trends in industrial applications warrant the need for such a technology since it minimizes security concerns. We consider the system in which the electronics on the tracked asset act as a transmitter sending its own identity periodically, where the frequency varies depending on how often the application requires updated location information. Additionally, in the available works such as RADAR and HORUS, the effect of the number of receivers on location accuracy is not discussed and analytical justification is not included. By contrast, in the proposed work, we analytically prove that accuracy improves with the number of receivers even though this may be costly. Therefore, we show that use of frequency diversity minimizes the cost while achieving better location accuracy.

A major challenge facing WLAN location determination is the dynamic nature of received signal strength and its wide variation with changes in the environment due to fading, shadowing etc. [10]. The factors include both small-scale and temporal effects, and such variation puts a limit on the achievable accuracy of the location determination system. The developers of HORUS suggest a small scale compensation method [11] based on observing the determined location of each object and perturbing the signal strength vector to better suit a reference location. However, there are several issues with



such an approach applied to an infrastructure based system. First, the object has to be located either continuously or often, to detect unexpected changes in location. Unfortunately, tags attached to assets for tracking in manufacturing shop floor environments are often energy-constrained and cannot transmit frequently [12] making the perturbation based continuous tracking unfeasible. Second, the suggested perturbation technique is not based on any true physics of radio communication. Finally, the computational overhead due to the perturbation technique is significantly high. By contrast, a novel approach based on frequency diversity and modified selection combining is introduced in order to overcome the above limitations.

Diversity has been a well-researched topic in the field of communications with the view of combating fading. It involves combining of multiple uncorrelated signal envelopes in order to obtain a signal with a higher signal to noise ratio (SNR). Several methods for signal combining have been developed [13] targeting SNR improvement. For location determination, achieving higher SNR does not necessarily result in better accuracy unless consistent received signal strength is achieved.

In the proposed work, it is demonstrated that frequency diversity can be employed to effectively reduce the variation in received signal strength values and as a result, improved accuracy is achieved in location determination. A new metric for selection combining is introduced and shown to reduce variance in signal strength when used with frequency diversity. The combination of frequency diversity with selection combining is shown to enhance the location accuracy of objects or assets.

The impact of number of receivers on location accuracy is analyzed and it is shown that diversity techniques provide an efficient alternative for compensation of small

scale and temporal variations and thus locating objects accurately. It is also presented that, for a given number of receivers, a system using frequency diversity with the proposed selection combining will perform better than a system without diversity. Experimental results from hardware verification by using wireless UMR motes demonstrate highly satisfactory results, validating our theoretical conjecture.

The paper is organized as follows. Section II presents the background on frequency diversity. Section III presents the proposed methodology, analytical results, and the implementation. Section IV presents and discusses hardware results. Section V concludes the paper and discusses paths for future work.

## II. BACKGROUND

In order to proceed, the following definitions are required. Subsequently, an overview of frequency diversity is discussed.

### A. Definitions

*RSSI (Received Signal Strength Indication)*: The average received signal strength at a given receiver during the reception of a packet, expressed in dBm, is known as *RSSI*.

*Diversity*: The use of multiple signal sources in order to improve the quality of the received signal is known as *diversity*. The different signal sources are referred to as *diversity branches*.

*Frequency Diversity*: When a signal is transmitted on multiple frequency channels and received on multiple channels by using a single antenna, the diversity created is called *Frequency Diversity*.

*Uncorrelated fading envelopes*: When a diversity scheme is capable of ensuring minimal correlation between the received signal strength values from multiple input signal sources (multiple channels in case of frequency diversity), such a scheme is said to result in *uncorrelated fading envelopes*. When the input channels in a diversity scheme are uncorrelated, effective mitigation of fading can be accomplished.

*Selection Combining*: The method of selecting one out of multiple signal sources in a diversity scheme by using SNR (select the one with higher SNR) as a criterion is known as *Selection Combining*.

In the proposed approach, the SNR criterion is replaced by *RSSI* (select the one with higher *RSSI*) since *RSSI*, and not SNR, is a representative function of transmitter location.

### ***B. Overview of Frequency Diversity***

There are three kinds of variations in signal strength: large-scale, small-scale, and temporal variations [8]. Location determination based on RSSI is dependent on large-scale variations of signal strength with distance, since this allows distinction between different locations. Small-scale variations in signal strength are caused by asset movements on the order of a fraction of a wavelength and are detrimental to accuracy in location determination. Additionally, temporal variations happen over time due to human and other activities, and environmental changes. In other words, location determination error due to both small-scale and temporal variations is caused by destructive fading occurring at the receiver from multiple paths. To combat such fading of wireless signals, multiple uncorrelated fading channels (multiple frequency channels) are employed at each receiver.

Motivation for use of diversity techniques stems from the fact that the probability of simultaneous deep fading occurring on two uncorrelated fading envelopes (in our case, resulting from frequency diversity) is much lower than the probability of a deep fade occurring on a single branch system [15]. Thus, employing a new selection combining approach on top of any diversity technique, which assures sufficiently uncorrelated channels, will reduce the variance in signal strength owing to small scale factors, which appears to be the major source of location determination errors.

The normalized correlation coefficient  $\rho(\Delta f)$  between the two fading envelopes from the input sources provided by frequency diversity (two separate frequency channels) is expressed as a function of frequency separation  $\Delta f$  [16] as

$$\rho(\Delta f) \cong \left(1 + (2\pi T \Delta f)^2\right)^{-\frac{1}{2}} \quad (44)$$

where  $\Delta f$  is the separation between the two frequency channels in use, and  $T$  is the maximum delay spread of the environment. For a typical indoor environment, at a carrier frequency of 2.4 GHz, the delay spread is shown to be of the order of 10 to 50 ns and 50 to 100 ns for typical indoor environment for Line-of-sight (LOS) and Non-line-of-sight (NLOS) environments respectively in literature [17]. For LOS situations, the LOS path is dominant and ensures that small scale and temporal variations do not affect signal strength. Hence, we take the value of 50 ns as representative of the worst case NLOS situations, for which case we propose the frequency diversity approach, since it can be seen that the lower the delay spread, the higher the correlation between the two fading envelopes.

In commercially deployable 802.11 systems for location determination using three non-overlapping channels of the 11 available channels, the maximum frequency channel separation available is 50 MHz. In the 802.15.4 physical layer specification used in the testing, the maximum value available is 55 MHz. This realistic value is used so that results from the work are applicable to 802.11 networks as well, and provide an upper limit benchmark since the frequency separation of 55 MHz is higher than available in the 802.11 case. For this value of frequency separation, we can see from (1) that the normalized correlation coefficient  $\rho(\Delta f)$  is 0.0578.

While this is theoretically sufficient to ensure uncorrelated fading envelopes on the signals from the two frequency channels, the correlation value is almost twice for a spatial diversity scheme involving an antenna separation of  $2\lambda$  [18]. Further, work in [19] indicates that the true correlation is often higher than the expected theoretical value. Hence, we can expect that while theoretically, a separation of 55 MHz is sufficient for

uncorrelated fading envelopes, practically, there still might be a fair degree of correlation and the accuracy improvement may not be as significant as seen with the spatial diversity scheme.

In the proposed work, two channels with frequency separation of 55 MHz are used to ensure uncorrelated fading channels. Section III shows how the proposed selection combining, employed with a two-branch diversity system, affects variation in received signal strength and lowers this variation. Consequently, it will be proven that reduced variance in signal strength renders improved location accuracy.

### III. PROPOSED METHODOLOGY

We prove that use of selection combining over two uncorrelated channels from frequency diversity results in reduction of variance in signal strength if the selection combining is performed by using an appropriate metric and in an adequate manner. Alternatively, it is demonstrated that an increase in the number of receivers can further enhance accuracy but at an increased cost. Actual implementation details of frequency diversity are given. RSSI values from the transmitter are used to arrive at an estimate of its location. An asset location tracking system is developed to determine whether the located asset is moving or stationary. Averaging of consecutive estimated locations of the transmitter is performed to improve location accuracy. For mobile assets, a prediction scheme is developed to identify future location of the asset for tracking applications. First, the source of errors in locating objects is discussed.

#### A. Source of Location Determination Errors

The location determination error in a probabilistic system is characterized in [18] in terms of probability distribution functions (PDF) of RSSI at each receiver from each reference grid location. For a system with  $k$  receivers trying to identify whether the transmission is originating from one of the two locations  $A$  and  $B$ , [18] derives the probability  $P_k^{A \rightarrow B}$  of wrongly identifying a transmission from location  $A$  as if it is coming from location  $B$  is

$$P_k^{A \rightarrow B} = P \left( \prod_{i=1}^k f_A^i(S_A^i) < \prod_{i=1}^k f_B^i(S_A^i) \right) \quad (1)$$

where  $S_A^i$  is the RSSI observed at receiver  $i$  from location  $A$ ,  $f_A^i$  is the PDF of RSSI observed

at receiver  $i$  from location  $A$ ,  $f_A^i(S_A^i)$  is the value of the PDF  $f_A^i$  at the RSSI value  $S_A^i$ ,  $f_B^i$  is the PDF of RSSI observed at receiver  $i$  from location  $B$ , and  $f_B^i(S_A^i)$  is the value of the PDF  $f_B^i$  at the RSSI value  $S_A^i$ . Equation (1) quantifies probability of erroneous identification in a probabilistic location determination system. This equation helps in further analysis of the location error with and without frequency diversity and to understand the impact of number of receivers on the location accuracy, which are presented in subsequent sections. Next we present analytical results with our proposed scheme where we demonstrate that frequency diversity enhances location accuracy and minimizes error.

### ***B. Frequency Diversity and Location Determination***

Lemma.3.1 (Variance Reduction with Frequency Diversity): For an indoor transmitter and receiver location pair with Rayleigh distribution of signal strength and frequency diversity, the variance in the signal strength distribution is reduced when the proposed selection combining approach with highest RSSI being the criterion is employed on two uncorrelated fading envelopes, compared with using a single input source.

Proof: It is shown in [18] that application of selection combining with selection of highest instantaneous RSSI from the two uncorrelated fading envelopes resulting from spatial diversity results in a reduction of variance in the RSSI distribution for a receiver-transmitter location pair by a factor of 13% compared to the single branch case. Since the use of frequency diversity is shown here to result in uncorrelated fading envelopes as is the case for spatial diversity, the proof follows exactly the same for frequency diversity as well. ■



Theorem 3.1 (Improved Location Determination with Frequency Diversity): For a given number of receivers, use of frequency diversity renders improved location accuracy for a pre-profiling based probabilistic WLAN location determination system.

Proof: Lemma 3.1 indicates that the proposed method of selection combining of two uncorrelated input sources from the application of frequency diversity reduces the variance of the received signal strength distributions. On the other hand, it is proven in [18] that reduction of variance in RSSI distributions from spatial diversity results in reduced location error. In case of frequency diversity also, it is indicated that the same level of variance reduction occurs. Therefore, frequency diversity reduces location determination error. Hence, it is shown that by using frequency diversity, the accuracy of determining location of an asset equipped with a transmitter is enhanced similar to the case of spatial diversity. ■

Next we present how increasing the number of receivers will indeed enhance the location accuracy.

### *C. Number of Receivers*

Theorem 3.2 (Location Accuracy with Number of Receivers): For a pre-profiled signal strength based probabilistic WLAN location determination system, the location accuracy with  $k+1$  receivers is better than the location accuracy with  $k$  receivers for all  $k > 0$ .

Proof: Analytical work in [18] shows that increasing the number of receivers always results in equal or better location determination accuracy. The case of  $k+1$  receivers is considered and shown to yield equal or lower location determination error compared to the case of  $k$  receivers for all  $k > 0$ . The proof applies in our case since

the same location determination system is considered for enhancement by addition of frequency diversity. ■

The theorems presented above show that the accuracy improves both with frequency diversity and increasing the number of receivers. Next, the proposed location determination schemes are introduced, which are built upon the known schemes, deterministic and probabilistic methods, from the literature.

#### ***D. Location Determination Algorithm***

Both probabilistic and deterministic techniques from the literature are evaluated with and without frequency diversity. Further, the application of diversity and proposed method of selection combining on top of either technique is discussed.

##### **1) Probabilistic technique**

A simplified version of HORUS [8], which is a probabilistic technique, is considered in this work. A grid is constructed to provide reference points, the coordinates of which are measured and recorded for mapping RSSI values to the location. The technique begins with an offline phase where the grid points are profiled and the signal strength distributions from each reference point at each receiver are parameterized and stored as the mean and variance. The process is detailed in [18].

Location determination is accomplished in the online phase by using the mapping constructed from the offline phase. The coordinates of the four reference locations with the highest probabilities of resulting in the obtained signal strength values are multiplied with the corresponding probabilities and a weighted averaging is performed to obtain the location estimate. This process is based on the center-of-mass technique [24]. Four locations are used since any point is enclosed by a square with four closest neighbors.

## 2) Deterministic technique

The first step in the deterministic technique [7] also involves construction of a reference grid and generating coordinates of reference grid points. In the offline phase, RSSI signature vectors are collected from all reference grid points at different times in a day and during the week. These different profiles are used to arrive at the average signal strength value from each reference point on the grid at each receiver. In the online phase, a signal strength vector is constructed from the RSSI values observed from a transmitter at each of the receivers. The Euclidean distance from this vector to each of the averaged profile entries is taken. The coordinates of the four reference points with the lowest Euclidean distance from their RSSI vectors recorded in the offline phase to the measured RSSI vector in the online phase are averaged to provide the location estimate.

## 3) Diversity and combining

There are two methods of implementing the proposed method of selection combining and frequency diversity using the probabilistic and deterministic schemes. It can be implemented on the hardware level using a time-based channel switching scheme where the receiver and the transmitter operate in one frequency channel for half of the time and another frequency channel for the rest as shown in Fig. 1(a). A second method of implementation would be at the software level, where two co-located receiver units operating at separate frequency channels are used and the higher RSSI value is selected while processing as shown in Fig. 1(b). We use the former implementation in our testbed as it is much easier to implement, uses fewer hardware components, and is representative of a real-life cost-effective implementation.

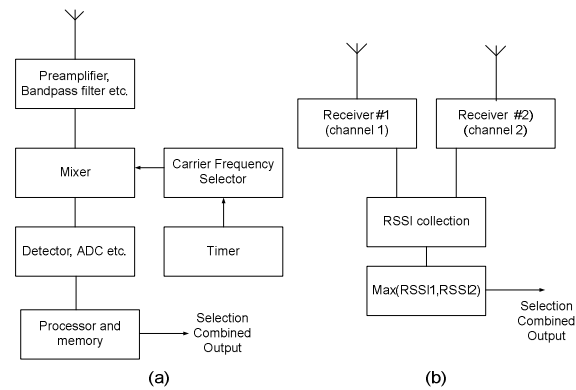

Fig. 1. (a) Timer-based implementation of frequency diversity and proposed selection combining approach (b) dual receiver implementation

In the location determination without using diversity, only RSSI values from one frequency channel from each pair is used in analysis, in both the online and offline stage. By contrast, in using the system with diversity applied, for each transmitter, the maximum of the two previously received RSSI values on each frequency channel is used in both stages. This selection is applied at the software level before using the RSSI values for processing in both online and offline stages. Thus, the location determination algorithm becomes a higher layer of processing when the combining layer is added as shown in Fig. 2.

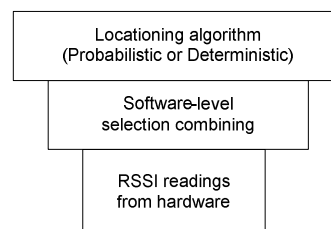

Fig. 2. Layered representation of the proposed method of selection combining

### ***E. Location Update Rate and Power Consumption***

Let us consider a normal location determination system not employing any kind of diversity. In this case, to maintain a location update rate of  $P$  per hour, the transmitter has to transmit only  $P$  times in an hour since the receivers are always available. Now, let us consider that the system utilizes spatial diversity of order  $n$  ( $n$  spatially diverse antennas per receiver) but with individual receivers at each antenna or with one receiver and RSSI monitoring at each antenna and persistent instantaneous switching to the antenna with highest RSSI at all times. To maintain the same location update rate  $P$  in this case, every transmission from the transmitter must be recorded at each of the spatially diverse antennas. But since each spatially diverse antenna in this case is equipped with a separate receiver or RSSI monitoring, the transmitter needs to maintain only a transmission rate of  $P$  transmissions per hour.

In a real life scenario, the instantaneous RSSI monitoring at each antenna is not feasible, hence in the single receiver case, the receiver would be forced to implement a round-robin switching between the antennas based on timers to implement spatial diversity. In such case, to maintain an update rate of  $P$  updates per hour, the transmitter will need to transmit  $n \bullet P$  times per hour. A similar analysis can be performed for frequency diversity implementations. Let us consider frequency diversity of order  $n$  ( $n$  frequency channels). First, we consider the case where  $n$  separate co-located receivers reside in the  $n$  frequency channels.

To result in one location update, the transmitter will now need to transmit  $n$  times, once in each channel. Similarly, to maintain an update rate of  $P$  per hour, the transmitter will need to make a total of  $n \bullet P$  transmissions per hour,  $P$  in each frequency channel.

Now, we use a single receiver switching between the  $n$  frequency channels. In this case, to result in one location update, a transmission from the transmitter has to be received by the receiver in each frequency channel. When a transmission is being made in a particular frequency channel  $i$ , the probability of the receiver being in that channel is given by  $1/n$ . Therefore, on the average,  $n$  transmissions need to be made in each channel to ensure reception. To complete a location update, reception must be ensured in all  $n$  frequency channels, hence  $n^2$  transmissions must be made in total to result in one location update. Extending, to maintain a location update rate of  $P$  per hour,  $n^2 \cdot P$  transmissions need to be made per hour. The above analysis is carried forward into a derivation for power consumption by the transmitter based on the type of diversity used, the type of implementation, the length of data packets, the required update rate, and other related variables.

We define the following variables for the power consumption analysis.

- $P$  = Required location update rate in the system (no. of transmissions per hour)
- $b$  = Bits per packet.
- $R$  = medium communication rate (bps)
- $P_t$  = Power consumed while transmitting.
- $P_s$  = Power consumed in standby/sleep mode
- $n$  = Order of spatial / frequency diversity employed  $J$  = Initial energy of transmitter battery (Joules)

The transmission time in seconds per hour  $T_t^n$  for a transmitter in a non-diversity system or a spatial diversity system with individual receivers per antenna or RSSI monitoring per antenna for a location update rate of  $P$  is given as

$$T_t^n = \frac{P \cdot b}{R} \quad (2)$$

For the spatial diversity system with one receiver switching between the antennas or the frequency diversity system with individual receivers assigned to each channel, the transmission time in seconds per hour  $T_t^s$  can be given as

$$T_t^s = \frac{P \cdot b \cdot n}{R} \quad (3)$$

Similarly, for a frequency diversity system with one receiver switching between the frequency channels, the transmission time in seconds per hour  $T_t^f$  is given as

$$T_t^f = \frac{P \cdot b \cdot n^2}{R} \quad (4)$$

Generally, in each case, the standby time of the transmitter in seconds per hour  $T_s$  is given as

$$T_s = 3600 - T_t \quad (5)$$

where  $T_t$  can be substituted with  $T_t^n$ ,  $T_t^s$  or  $T_t^f$  depending on the system configuration. In continuation, the power consumed in Watts  $W$  can be given as

$$W = \frac{T_t \cdot P_t + T_s \cdot P_s}{3600} \quad (6)$$

From the initial available energy in the battery, the lifetime of the battery  $L$  in seconds of operation can be calculated as

$$L = J / W \quad (7)$$

It can be deduced that transmission power levels will be much higher than standby / sleep power levels. Further, frequency diversity implementation with a single receiver switching between channels has  $n$  times the transmission rate of spatial diversity

implementation with a single receiver switching between antennas; it can be seen that power consumption will be much higher for the former. The magnitude of the difference will depend on the number of channels in use. Detailed calculation results for power consumption analysis based on realistic variable values are presented in Section IV.

#### ***F. Tracking, Averaging and Prediction***

The two-step motion detection process detailed in [18] is used here. Irrespective of whether diversity is used and which diversity technique is employed, the technique renders itself applicable to location determination in general. The process involves recording cumulative motion in x and y directions over short time intervals, and averaging these cumulative motion values over a larger time interval to detect directed motion. The developed trend values can be used to estimate a trend of asset movement as well. Since the algorithm is independent of diversity, the process follows the motion detection detailed in [18].

The method for averaging located coordinates from [18] is also used here to improve accuracy. The process includes a small time-scale averaging of x and y coordinates to compensate scattering due to temporal variations in the channel and a larger time-scale averaging of the averaged values for improved location accuracy. The averaging results in a higher accuracy in location reporting but at the cost of delayed location reporting. The averaging follows the process detailed in [18].

Further, the movement trend evolved from the motion detection algorithm and the averaged location estimate are combined to evolve an estimate for current location, at a better accuracy level than the non-averaging based system, while compensating for the additional delay introduced by averaging. Further, the same technique can be extended to



predicting future locations based on the estimated current location and the motion trend. This trending and prediction scheme follows the work in [18].

Accuracy of the motion detection, tracking and prediction schemes is discussed in Section IV for stationary and moving targets for probabilistic and deterministic methods with and without applying frequency diversity.

## IV. EXPERIMENTAL RESULTS AND ANALYSIS

First, we discuss the test bed followed by the results and analysis.

### A. *Testbed and Implementation*

All experiments were conducted using G4-SSN motes developed at UMR, shown in Fig. 3. They have been used in prior work relating to wireless sensor networks [21], [22].

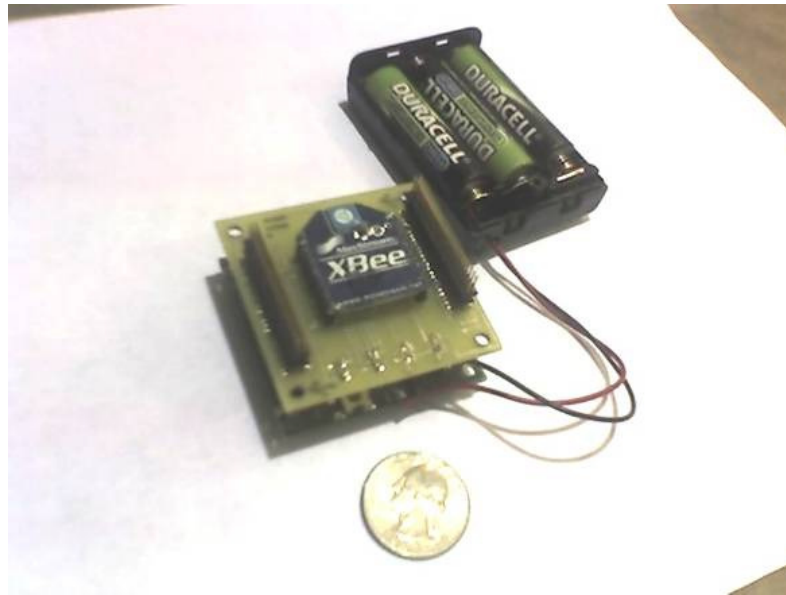

Fig. 3. UMR G4-SSN embedded wireless sensor networking platform

The wireless platform chosen was IEEE 802.15.4. All nodes are equipped with XBee pro radios from Maxstream [23] with 18 dBm of transmit power. With reference to frequency diversity, the XBee pro radios support 12 non-overlapping channels, where

each channel is separated by 5 MHz from the next one. Thus, we obtain a maximum frequency deviation of 55 MHz which is shown to be adequate in Section II B. Further, the XBee pro allows quick switching of channels by simply issuing a ‘channel switch’ command from the microcontroller. In the testbed, the transmitter is made to switch every 100 milliseconds while the receivers switch between the channels every 500 milliseconds. The transmission interval must be an odd multiple of the transmitter switching interval to ensure that alternate transmissions occur from alternate channels. In addition, the transmission rate in the diversity case has to be higher than in the non-diversity case to maintain the same location update rate in the system. This will be evolved in Section IV. C and the implications on transmitter power consumption will be dealt with.

Two floors of the Engineering Research Laboratory (ERL) building were used for the purpose of testing location accuracy. Only corridors were used in the evaluation. A total of 133 points were marked as reference grid points in a total 3624 sq. ft. of corridor area. Further, 44 test points are marked as off-grid points for accuracy evaluation. The offline training phase for both deterministic and probabilistic methods involves profiling from the 133 reference grid points. For testing accuracy, transmissions from the 44 off-grid test points are attempted to be located. Five receivers are used in the system, two on the third floor and three on the second floor. The floor plans of the ERL are given in Fig. 4 and Fig. 5 and the positions of receivers are marked with circled squares.



Fig. 4. Floor plan of ERL third floor. Receiver pair positions are marked with circled squares



Fig. 5. Floor plan of ERL second floor. Receiver pair positions are marked with circled squares

### ***B. Algorithm Pseudocode***

The pseudocode for probabilistic location determination is presented in Table I and the pseudocode for deterministic location determination is given in Table II.

Table I Pseudocode for probabilistic location determination

---

```

RSSI Signature vector received
for all reference points, do
    Calculate probability of receiving given RSSI vector from location
end for
Sort list of points in descending order of probability
Weight the coordinates with their respective probabilities
Return mean of weighted coordinates of best four reference points
end

```

---

Table II Pseudocode for deterministic location determination

---

```

RSSI Signature vector received
for all reference points, do
    Calculate Euclidean distance between profiled average SS vector
    and received RSS vector
end for
Sort list of points in ascending order of Euclidean distance
Return mean of coordinates of best four reference points
end

```

---

### ***C. Asset Location Tracking and Averaging***

For evaluating the location tracking and averaging system, a continuous path is set up on the second floor of ERL including 96 points each 27 inches apart from the

previous point. The path consists of three linear sections separated by two corners to introduce non-linear path into the accuracy evaluation. The transmitter is allowed to move along this path and made to transmit at the marked points at one second intervals. The averaging, tracking, and prediction algorithms are executed on the obtained consecutive location coordinates. The accuracy results are discussed next.

#### ***D. Results and Analysis***

Now the results are given followed by the analysis

##### **1) Frequency and spatial diversity and location determination accuracy**

Hardware results are classified into two scenarios based on the application of probabilistic and deterministic techniques. The mean accuracy in each case is plotted against the number of receivers used in the analysis. Accuracy without applying the diversity technique is compared with accuracy when spatial and frequency diversities are employed. In each case, the cumulative distribution function of the location error is also presented with and without applying diversity. Finally, four sample offgrid points from the testing data set are taken and determined locations in each case are provided using either technique without diversity, with spatial diversity, and with frequency diversity. A summary table is also included providing mean, median, and 90<sup>th</sup> percentile accuracy levels for each case. Finally, the two techniques are compared and improvement in accuracy due to introduction of frequency and spatial diversity is demonstrated and evaluated.

It can be seen from Fig. 6(a) that use of spatial or frequency diversity outperforms the single branch case consistently. For 40 % of the time, frequency diversity provides lower error than spatial diversity also, but its worst case error performance is low, around

the same level as the single branch case. Fig. 6 (b) shows that improvement from the use of diversity is consistent irrespective of the number of receivers in use; and the accuracy in the frequency diversity case is clearly seen to be between the single branch and spatial diversity cases. Further, with an increase in the number of receivers, the mean location error decreases from 178 to 87 inches, 170 to 78 inches and from 128 to 60 inches in the single branch case, frequency diversity case, and the spatial diversity case, respectively.

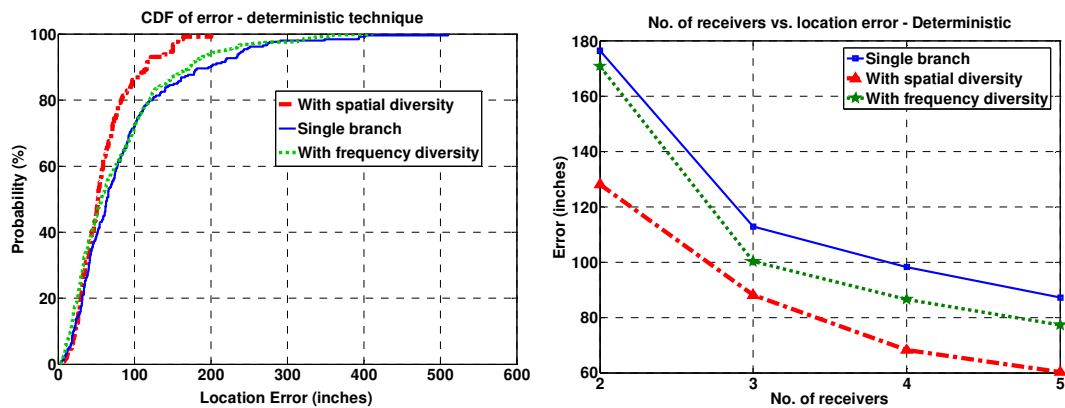

Fig. 6. Deterministic technique (a) cumulative distribution function of location error (b) location error as a function of number of receivers

For the probabilistic method, a similar trend can be observed again. While frequency diversity performs better than or almost as good as spatial diversity, the worst case error shoots up to meet the values in the single branch case. Both diversity techniques outperform the single branch case here as well as indicated in Fig. 7(a). On the other hand, Fig. 7 (b) presents the reduction in mean error with the number of receivers both with and without diversity. Frequency diversity once again performs

between the single branch case and the spatial diversity case. Diversity techniques are seen to result in substantial accuracy improvement. For instance, with five receivers in the system, the mean errors are 95, 78, and 64 inches in the single branch case, the frequency diversity case, and the spatial diversity case, respectively.

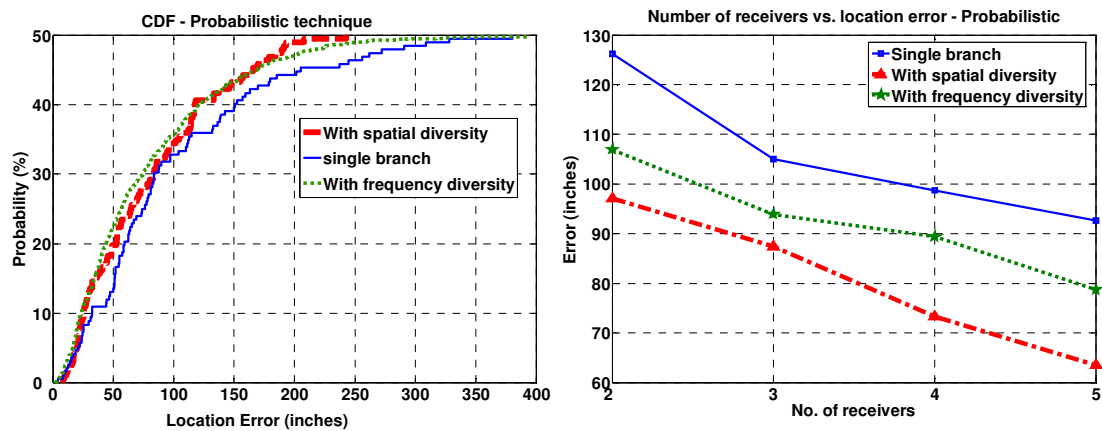

Fig. 7. Probabilistic technique - (a) cumulative distribution function of location error (b) location error as a function of number of receivers

Table III presents location results for four points in the profiling. In general, frequency diversity based location estimation is closer to the actual location compared to the single branch case, but is not as accurate as the spatial diversity case.

Table IV presents the summary of accuracy levels in all cases. Mean, median, and 90<sup>th</sup> percentile levels of location error are presented. It is seen that frequency diversity on the average results in a reduction of 20% in location error while spatial diversity is able to reduce it by an additional 20% to 22% over frequency diversity. Performance of frequency diversity is seen to lie between that of the single branch case and the spatial



diversity case. This can be explained by the higher level of correlation between the signal sources as derived in Section II A.

Table III: Performance comparison with and without diversity and number of receivers

	Point 1		Point 2		Point 3		Point 4	
	x	y	x	y	x	y	x	y
True coordinates	1121.5	366.1	1152.5	451.1	199.4	748.1	1121.7	633.0
Probabilistic single branch	1147.2	548.0	1137.4	150.7	232.4	726.9	1123.5	465.6
Probabilistic spatial diversity	1134.3	321.8	1152.3	386.3	233.3	745.2	1130.1	531.1
Probabilistic frequency diversity	1137.4	489.6	1146.3	375.2	223.7	702.2	1125.4	506.4
Deterministic single branch	1149.2	336.0	1155.1	493.3	240.3	737.6	1134.8	490.3
Deterministic spatial diversity	1145.2	340.6	1148.0	491.4	204.2	730.7	1144.7	543.7
Deterministic frequency diversity	1143.1	330.9	1142.3	432.2	228.1	732.2	1138.1	601.4

Table IV: Summary of location determination error levels

		Probabilistic Technique	Deterministic Technique
Mean error (inches)	Single Branch	93.2	87.2
	Spatial Diversity	63.4	60.3
	Frequency Diversity	77.36	78.43
Median error (inches)	Single Branch	73.9	64.2
	Spatial Diversity	64.2	52.5
	Frequency Diversity	57.0	57.2
90 <sup>th</sup> percentile error (inches)	Single Branch	205.3	200.4
	Spatial Diversity	165.7	116.2
	Frequency Diversity	172.0	169.2

## 2) Location update rate and power consumption

In order to analyze the battery lifetime variation with the different configurations, we use the following realistic values for the variables.  $P$  (update interval) = (1 sec, 15 sec, 1 minute, 1 hour, 4 hours),  $b$  (bits per packet) = 256 bits,  $R$  (data rate) = 250 kbps,  $P_t$  (transmission power) = 500 mW,  $P_s$  (standby / sleep power) = 0.05 mW,  $n$  (number of channels) = (2,11),  $J$  (available energy at start) = 30 KJ. Fig. 8 gives the battery lifetime statistics for different levels of diversity with the above parameters.

It can be seen from Fig. 8 that the system with frequency diversity performs worst in terms of battery lifetime. While in the normal system, a transmitter can have almost two years of life with a one second transmit interval, use of diversity schemes reduces the life to one year for the two branch case and to almost zero for the eleven-branch case.

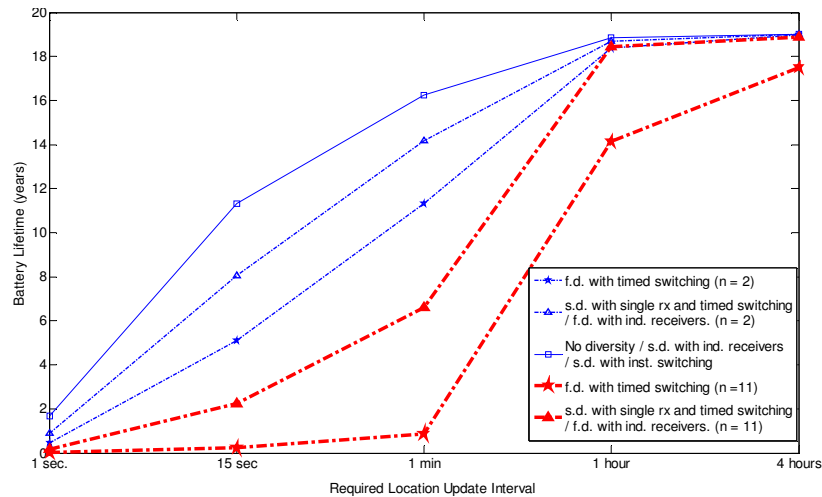

Fig. 8. Battery lifetime vs. location update interval

The gap between spatial and frequency diversity can be seen to grow with the order of diversity employed. When eleven channels are employed, even with an update interval of four hours, the frequency diversity system with timer-based channel switching still falls three years short on life. It has been shown that with an ideal battery (no degradation other than charge depletion due to usage), a transmitter can last as long as 18 years even with use of diversity, with a location update rate of once every four hours.

### **3) Location tracking, averaging and prediction**

The motion detection algorithm works extremely well and it is able to detect moving assets 99% of the time. After testing with a stationary asset, the algorithm reports a false alarm of only 2%. The algorithm is tested with both the probabilistic and deterministic techniques, with and without applying diversity. The results are shown in Fig. 9.

Further, we evaluate the accuracy of the averaged location, the estimate of the current location and the predicted location one second into the future. It is seen that for a mobile asset, the accuracy of the averaged coordinate is much better than the calculated location based on a single set of RSSI values. Even the estimate of current location based on averaging and motion trending appears to be better than the non-averaged RSSI locations. The predicted location one second into the future is on the average as accurate as the single set RSSI location, and considering that this is a prediction, the values are reasonable. The mean accuracy levels in inches are shown in Fig. 10 and Fig. 11.

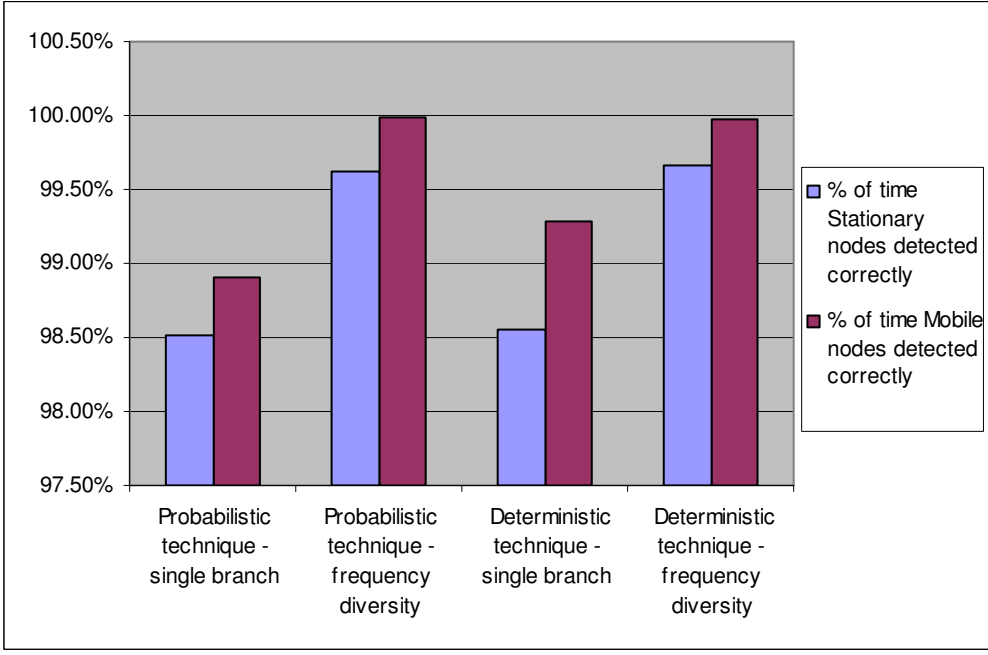

Fig. 9. Successful detection of mobile and stationary assets

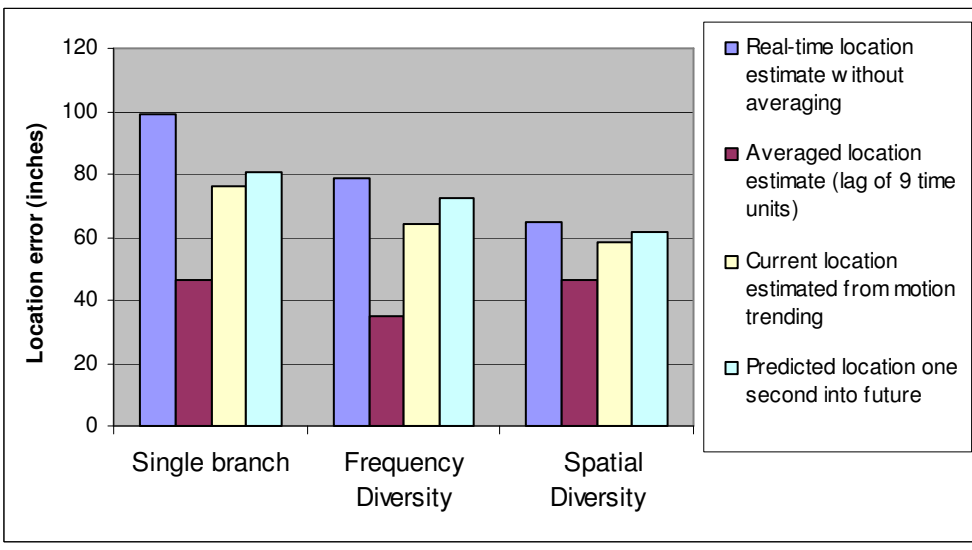

Fig. 10. Accuracy levels of averaging and prediction techniques for mobile assets (Deterministic technique)

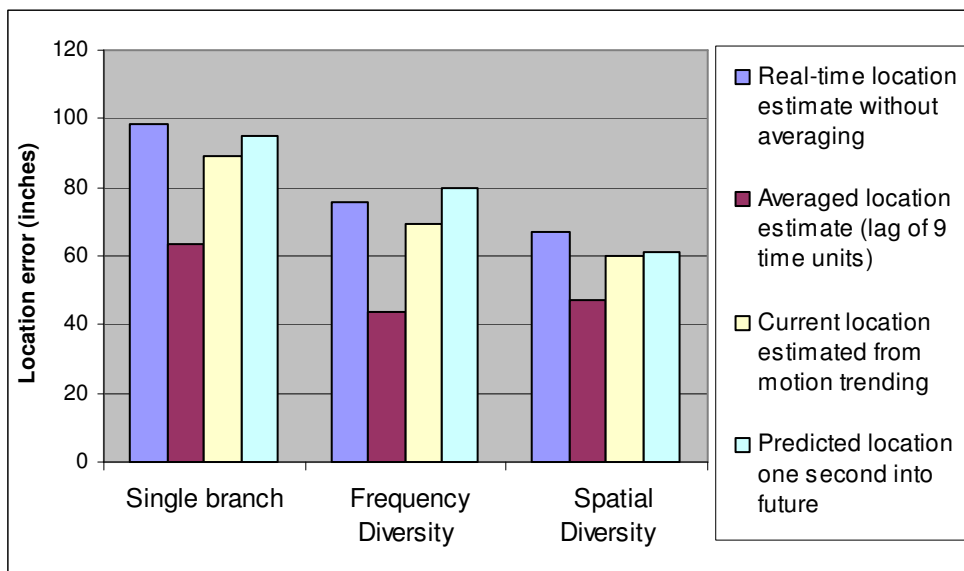

Fig. 11. Accuracy levels of averaging and prediction techniques for mobile assets (Probabilistic technique).

## V. CONCLUSIONS

It is observed that while frequency diversity with the proposed method of selection combining is effective in improving accuracy in both probabilistic and deterministic location determination schemes, the performance does not meet the improvement resulting from spatial diversity. Implementation of frequency diversity is cheaper since it does not require any additional hardware. Comparing against the increase in the number of location sensors, which resulted in improved accuracy, the use of frequency diversity is suggested to affect drastic improvements in accuracy without adding any cost to the system. In fact, improvement of 18 – 23% in average location error is noticed from introduction of frequency diversity alone.

Motion detection, averaging, and prediction techniques are developed and implemented. Substantial accuracy improvements are seen as a result of addition of these methods as well, over and above the improvements from frequency diversity. Further, detailed analysis of power consumption for single branch, spatial diversity, and frequency diversity based systems show that frequency diversity significantly reduces battery lifetime on the transmitter. Hence, in selecting frequency or spatial diversity for a location determination system, a compromise must be evolved between battery life, location accuracy, and increased hardware cost.

## REFERENCES

- [1] Priyantha, N. B., Chakraborty, A., and Balakrishnan, H. 2000. "The Cricket location-support system," *Proceedings of the 6th Annual international Conference on Mobile Computing and Networking* (Boston, Massachusetts, United States, August 06 - 11, 2000). MobiCom '00. ACM Press, New York, NY, 32-43.
- [2] Want, R., Hopper, A., Falcão, V., and Gibbons, J. 1992. "The active badge location system," *ACM Trans Inf. Syst.* 10, 1 (January 1992), 91-102.
- [3] Hightower, J., and Borriello, G. "Location systems for ubiquitous computing," *Computer*, vol.34, no.8pp.57-66, August 2001.
- [4] Zeimpekis, V., Giaglis, G. M., and Lekakos, G. 2002. "A taxonomy of indoor and outdoor positioning techniques for mobile location services", *SIGecom Exch.* 3, 4 (December 2002), 19-27.
- [5] Li, X., and Pahlavan, K., "Super-resolution TOA estimation with diversity for indoor geolocation," *IEEE Transactions on Wireless Communications*, vol.3, no.1pp. 224- 234, January 2004.
- [6] Caffery, J.J., and Stuber, G.L. "Overview of radiolocation in CDMA cellular systems," *IEEE Communications Magazine*, vol.36, no.4pp.38-45, April 1998.
- [7] Bahl, P., and Padmanabhan, V.N. "RADAR: an in-building RF-based user location and tracking system", *Proceedings of the IEEE Nineteenth Annual Joint Conference of Computer and Communications Societies, INFOCOM 2000* , vol.2, pp.775-784, 2000.

- [8] Youssef, M., and Agrawala, A. "The Horus WLAN location determination system," *Proceedings of the 3rd international Conference on Mobile Systems, Applications, and Services* (Seattle, Washington, June 06 - 08, 2005). MobiSys '05. ACM Press, New York, NY, 205-218.
- [9] Ganu, S., Krishnakumar, A.S., and Krishnan, P. "Infrastructure-based location estimation in WLAN," *Proc. of the Wireless Communications and Networking Conference*, vol.1, no.pp. 465- 470 vol.1, 21-25 March 2004.
- [10] Kaemarungsi, K., Krishnamurthy, P. "Properties of indoor received signal strength for WLAN location fingerprinting," *Proc. of the First Annual International Conference on Mobile and Ubiquitous Systems: Networking and Services, (MOBIQUITOUS 2004)*, vol., no.pp. 14- 23, August 2004
- [11] Youssef, M., and Agrawala, A. "Small-scale compensation for WLAN location determination systems," *Proc. of the IEEE Wireless Communications and Networking, 2003* , vol.3, no.pp. 1974- 1978 vol.3, March 2003.
- [12] Aeroscout Enterprise Visibility Solutions., "<http://www.aeroscout.com>"
- [13] Eng, T., Ning, K., Milstein, L.B. "Comparison of diversity combining techniques for Rayleigh-fading channels," *IEEE Transactions on Communications*, vol.44, no.9, pp.1117-1129, September 1996.
- [14] Youssef, M., and Agrawala, A. "On the Optimality of WLAN Location Determination Systems", *Technical Report UMIACS-TR 2003-29 and CS-TR 4459*, University of Maryland, College Park, March 2003.



- [15] Parsons, J.D., Henze, M., Ratliff, P.A., and Withers, M.J. "Diversity techniques for mobile radio reception," *IEEE Transactions on Vehicular Technology*, vol.25, no.3, pp. 75- 85, August 1976.
- [16] Clarke. R.H., "A statistical theory of mobile radio reception," *Journal of Bell Syst. Tech.*, vol. 47, no. 6, pp. 957-1000, July-August 1968
- [17] Zepernick, H.-J., Wysocki, T.A. "Multipath channel parameters for the indoor radio at 2.4 GHz ISM band," *Vehicular Technology Conference, 1999 IEEE 49th* , vol.1, no.pp.190-193 vol.1, July 1999
- [18] Ramachandran A., and Jagannathan, S., "Accuracy Improvement Using Spatial Diversity for Signal Strength based WLAN Location Determination Systems," *Internal Reports*, Embedded Systems and Networking Laboratory, Department of Electrical and Computer Engineering, University of Missouri – Rolla, September 2006.
- [19] Corazza, G.E., Degli-Esposti, V., Frullone, M.; Riva, G. "A characterization of indoor space and frequency diversity by ray-tracing modeling," , *IEEE Journal on Selected Areas in Communications*, vol.14, no.3pp.411-419, April 1996
- [20] Saleh, A., Valenzuela, R. "A Statistical Model for Indoor Multipath Propagation," *IEEE Journal on Selected Areas in Communications*, vol.5, no.2, pp. 128- 137, February 1987
- [21] Hayter, A.J. *Probability and Statistics for Engineers and Scientists*, PWS Publishing Company, Boston, 1996.

- [22] Fonda, J., Zawodniok, M., Jagannathan, S., and Watkins, S.E. "Adaptive Distributed Fair Scheduling and Its Implementation in Wireless Sensor Networks," *Proc. of the IEEE International Conference on Systems, Man, and Cybernetics*, pp. 3382-3387, October 2006.
- [23] Fonda, J., Zawodniok, M., Jagannathan, S., and Watkins, S.E. "Development and Implementation of Optimized Energy-Delay Sub-network Routing Protocol for Wireless Sensor Networks," *Proc. of the IEEE International Symposium on Intelligent Control*, pp. 119-124, Oct 2006.
- [24] Maxstream XBee and XBee pro OEM RF modules., <http://www.maxstream.net>.
- [25] Youssef, M., and Agrawala, A. "Continuous space estimation for WLAN location determination systems," *Proceedings of the 13th International Conference on Computer Communications and Networks, 2004. ICCCN 2004.*, vol., pp. 161- 166, October 2004.
- [26] Bahl, P., Balachandran, A., Padmanabhan, V. N. "Enhancements to the RADAR User Location and Tracking System," *Microsoft Research Technical Report*, February 2000.

## VITA

Anil Ramachandran was born in Pandalam, Kerala, India on March 27, 1983. He completed his Bachelor of Technology degree in Electronics and Communication from Cochin University of Science and Technology in May 2004. He joined University of Missouri-Rolla in Spring 2005 for a Master of Science program and received the degree in May 2007.

