

01 Jan 2003

## Comparison of 3-, 5-, and 6-Phase Machines for Automotive Charging Applications

B. Zhang

Hua Bai

Walter Eversman

*Missouri University of Science and Technology*, [eversman@mst.edu](mailto:eversman@mst.edu)

Ronald J. Krefta

*et. al.* For a complete list of authors, see [https://scholarsmine.mst.edu/mec\\_aereng\\_facwork/3353](https://scholarsmine.mst.edu/mec_aereng_facwork/3353)

Follow this and additional works at: [https://scholarsmine.mst.edu/mec\\_aereng\\_facwork](https://scholarsmine.mst.edu/mec_aereng_facwork)



Part of the [Aerospace Engineering Commons](#), and the [Mechanical Engineering Commons](#)

---

### Recommended Citation

B. Zhang et al., "Comparison of 3-, 5-, and 6-Phase Machines for Automotive Charging Applications," *Proceedings of the IEEE International Electric Machines and Drives Conference, 2003*, Institute of Electrical and Electronics Engineers (IEEE), Jan 2003.

The definitive version is available at <https://doi.org/10.1109/IEMDC.2003.1210628>

This Article - Conference proceedings is brought to you for free and open access by Scholars' Mine. It has been accepted for inclusion in Mechanical and Aerospace Engineering Faculty Research & Creative Works by an authorized administrator of Scholars' Mine. This work is protected by U. S. Copyright Law. Unauthorized use including reproduction for redistribution requires the permission of the copyright holder. For more information, please contact [scholarsmine@mst.edu](mailto:scholarsmine@mst.edu).

# Comparison of 3-, 5-, and 6-Phase Machines For Automotive Charging Applications

B. Zhang, H. Bai, S. D. Pekarek, W. Eversman<sup>†</sup>

Department of Electrical and Computer Engineering

<sup>†</sup>Department of Mechanical Engineering

University of Missouri - Rolla

Rolla, MO 65409-0040

R. Krefta, G. Holbrook, D. Buening

Delphi

2705 S. Goyer Road

Kokomo, IN 46904-9005

**Abstract** - In this paper, the performance of a 5-phase claw-pole machine/converter system is compared with those of 3-phase and 6-phase systems of the same volume. It is shown that the acoustic output of the 5-phase machine compares favorably with that of the 6-phase machine and is much lower than that of the 3-phase machine over a majority of the operating range. In addition, the output current produced by the 5-phase machine is, in general, 6-8% higher than those of the 3-phase and 6-phase machines. These results suggest that for maximizing power density while minimizing cost and acoustic noise, 5-phase machines provide a competitive alternative to 6-phase machines of identical volume.

## I. INTRODUCTION

Traditionally, automotive generation systems have been comprised of a 3-phase Lundell (claw-pole) synchronous machine connected to an uncontrolled 6-pulse rectifier. One of the primary design requirements of these systems is maximizing power density subject to the constraint of minimizing overall system cost. However, with progress made in reduction of automotive drive train noise, the generating system has been found to be a dominant noise source under idle conditions at high electrical load. Thus, an added design constraint is the minimization of acoustic noise produced by the machine. To reduce the acoustic noise, the use of 6-phase machines/12-pulse rectifiers has been proposed [1]. Specifically, the 6-phase machines that have been developed are constructed with two sets of 3-phase stator windings that are displaced by 30 electrical degrees. Although the sources of acoustic noise from automotive generators have not been previously detailed in open literature, utilization of 6-phase machines is a relatively common method used to reduce the torque ripple produced by synchronous and induction machines [2-6].

As a means to mitigate torque ripple by increasing the number of stator phases, the 6-phase machine has received the most attention. However, there has been research to indicate that 5-phase machines can also be effective. Specifically, in [7] it was shown that in a 10-pulse voltage-source induction motor drive, the torque ripple produced was one-third the amplitude and at a higher frequency than a corresponding 6-pulse/3-phase system. In related research on 5-phase reluctance machines, it has been shown that stator current harmonics can be controlled to produce average

torque, increasing the torque/ampere over 3-phase machines of similar volume [8].

In this paper, the performance of a 5-phase claw-pole machine/rectifier system is compared with those of 3-phase and 6-phase systems of the same volume (outside diameter and length). The indices of primary interest are those of acoustic noise and output power over rotor speeds of 1500-6000 rpm, as well as cost and reliability. It is shown that the acoustic output of the 5-phase machine compares favorably with that of the 6-phase machine and is much lower than that of the 3-phase machine over a majority of the operating range. In addition, the output current produced by the 5-phase machines is, in general, on the order of 6-8% higher than those of the 3-phase and 6-phase machines. These results suggest that for maximizing power density while minimizing cost and acoustic noise, 5-phase machines provide a competitive alternative to 6-phase machines of identical volume.

## II. ACOUSTIC NOISE IN AUTOMOTIVE GENERATORS

The stator of a claw-pole synchronous machine is similar to those of wound-rotor synchronous machines used in large utility applications. The rotor pole faces have a trapezoidal, or claw shape and the two sets of claws are nested to form pole pairs. In automotive charging systems, the stator phase windings are generally concentrated (1 slot/pole/phase), the rotor contains 12 poles, and the 3-phase stator terminals are connected to a 6-pulse rectifier, as shown in Fig. 1.

In these systems the primary acoustic output that receives significant attention is the noise that is generated at 6 times the rotor electrical speed (6<sup>th</sup> order electrical, 36<sup>th</sup> order mechanical). Evaluating potential sources of noise, there are harmonics in the magnetic field in the airgap that create radial forces with a 6<sup>th</sup> order component that act on the stator/rotor structures. Harmonics of the same order appear in tangential forces acting on the stator/rotor structures, which yields torque ripple.

Extensive investigation has led to the conclusion that the conversion of torque ripple into the dynamic response of the mounting system is a predominant source of noise. Among the studies used to draw this conclusion were acoustic noise measurements on machines with varying mount compliance,

acoustic noise tests with shrouded stators, and data from accelerometers mounted on a lever arm extended from a free-compliant stator.

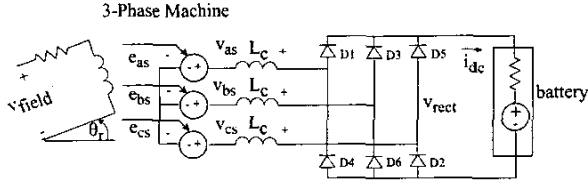

Figure 1. Traditional automotive charging system.

To establish an expected difference in the acoustic noise produced by 3-, 5- and 6-phase claw-pole machines, lumped-parameter models have been utilized. Within the models the electromagnetic torque is expressed in terms of the co-energy of the coupling field as [9]

$$T_e = \frac{P}{2} \frac{\partial W_c}{\partial \theta_r} \quad (1)$$

where  $\theta_r$  is the electrical rotor position and  $P$  is the number of poles. In the linear magnetic region, the co-energy can be expressed in terms of stator currents and self- and mutual-inductances as

$$W_c = \frac{1}{2} \begin{bmatrix} i_{abc} & i_{fd} \end{bmatrix} \begin{bmatrix} \mathbf{L}_{ss}(\theta_r) & \mathbf{L}_{sfd}(\theta_r) \\ \mathbf{L}_{fds}(\theta_r) & L_{ffd}(\theta_r) \end{bmatrix} \begin{bmatrix} i_{abc} \\ i_{fd} \end{bmatrix} \quad (2)$$

where  $\mathbf{L}_{ss}(\theta_r)$ ,  $\mathbf{L}_{sfd}(\theta_r)$ , and  $\mathbf{L}_{fds}(\theta_r)$  are matrices that contain the stator self- and mutual-inductances, and stator-rotor mutual inductances respectively. The scalar  $L_{ffd}(\theta_r)$  represents the field winding self-inductance. In [10] a lumped parameter model of the 3-phase machine is described wherein the harmonics introduced by rotor saliency, stator slots, and winding harmonics are included in the derivation of the model. The inductances are expressed in a closed form

$$L_{aas} = L_{ls} + L_a + L_{b1} \cos(2\theta_r + \phi_{b1}) + \dots, \quad (3)$$

$$L_{bas} = L_{am} + L_{bm} \cos(2\theta_r + \phi_{bm}) + \dots, \quad (4)$$

$$L_{asfd} = \sum_{k=1,3,5,7} L_{afk} \cos(k\theta_r + \phi_{afk}), \quad (5)$$

$$L_{ffd} = L_{lfd} + L_{fd}(\theta_r), \quad (6)$$

where  $L_{aas}$  is the phase- $a$  self inductance,  $L_{asbs}$  is the phase- $a$  to phase- $b$  mutual inductance, and  $L_{asfd}$  is the phase- $a$  to field mutual inductance.

In the nonlinear magnetic region, where the machine is typically operated in automotive applications, (2) is not an exact representation for co-energy, and numerical techniques are used to determine the co-energy as a function of state. However, it is convenient to use the linear expression to consider harmonic content. Evaluating (1) using inductances of the form of (3)–(6) in (2) yields a torque expression

$$T_e = \frac{P}{2} \left[ \left( \frac{\partial L_{aas}}{\partial \theta_r} \frac{i_{as}^2}{2} + \frac{\partial L_{asbs}}{\partial \theta_r} i_{as} i_{bs} + \dots + \frac{\partial L_{cas}}{\partial \theta_r} \frac{i_{cs}^2}{2} \right) + \left( \frac{\partial L_{asfd}}{\partial \theta_r} i_{as} + \frac{\partial L_{bsfd}}{\partial \theta_r} i_{bs} + \frac{\partial L_{csfd}}{\partial \theta_r} i_{cs} \right) i_{fd} + \frac{\partial L_{ffd}}{\partial \theta_r} \frac{i_{fd}^2}{2} \right] \quad (7)$$

The first term in the parenthesis on the right represents the torque that is due to the saliency of the rotor, the second is due to the coupling between magnetic fields created by stator and rotor current, and the third is due to the interaction of the rotor magnetic field and the stator slots (cogging torque). Torque ripple results from each of these respective sources. The torque ripple components of the 3-phase machine (one slot/pole/phase) are at multiples of the 6<sup>th</sup> order of rotor electrical frequency. For the 5-phase machine (one slot/pole/phase) the torque ripple components are at multiples of the 10<sup>th</sup> order of rotor electrical frequency, and for the 6-phase machine (one slot/pole/phase) the torque ripple components are at multiples of the 12<sup>th</sup> order of rotor electrical frequency.

A comparison of the respective frequencies and amplitudes of the torque ripple at a mechanical speed of 2000 rpm predicted from models of each of the machines (operating in the linear magnetic range) is shown in Fig. 2. From the figure it can be seen that the 10<sup>th</sup> harmonic of the 5-phase machine is roughly 1/3 the amplitude of the 6<sup>th</sup> harmonic of the 3-phase machine and approximately 30% higher than the 12<sup>th</sup> harmonic of the 6-phase machine.

In saturation, the ratio between the harmonics of the torque ripple of the machines is not necessarily fixed. Specifically, each of the harmonic components of the air gap flux density changes due to changing flux distribution along the claw, which alters the harmonic content of the torque produced by each machine.

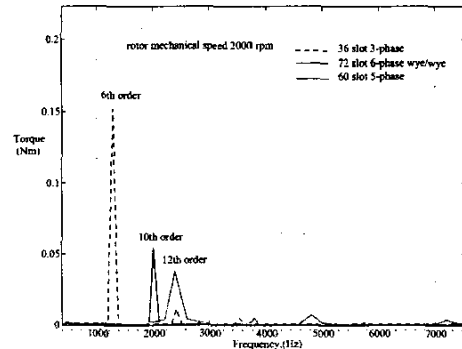

Figure 2. Example of torque harmonic spectrum.

A model of the 3-, 5-, and 6-phase machines has been created in which the effects of saturation are approximated using techniques described in [11]. Therein, the harmonics of the airgap MMF are expressed as a function of  $d$ -axis flux. For the machines studied over the speed range of 1500-6000 rpm with 5A field excitation and a 14V battery as the load, the 6-phase machine has 12<sup>th</sup> order of torque ripple in the range of 0.1-0.2 Nm, while the 10<sup>th</sup> order of torque ripple of the 5-phase machine is consistently on the order of 30% higher than that of the 6-phase machine. The 3-phase machine has 6<sup>th</sup>-order torque ripple that increases nearly linearly from 0.8-1.4 Nm from 1500-6000 rpm.

Experimental validation has been performed to compare the acoustic noise produced by the three machines. The results of the comparison are shown in Fig. 3. It is noted there is not a one-one correspondence between the respective torque ripple amplitudes and acoustic noise at a given rotor speed, since the frequencies of the ripple are different for each machine. The acoustic noise data is also presented on a dB scale. Nonetheless as shown, the 5-phase machine is at least 8-10 dB below that of the 3-phase machine over the majority of the speed range. As expected, the 6-phase machine has less acoustic output than the 5-phase machine.

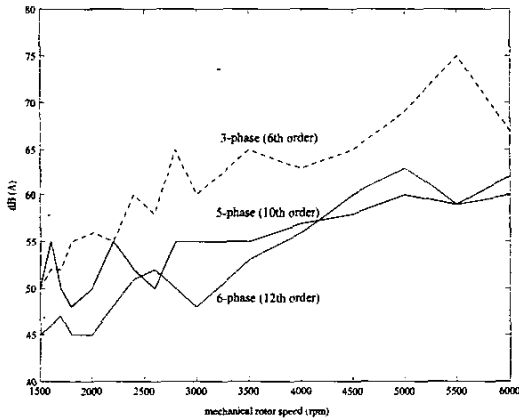

Figure 3. Measured sound pressure levels of 3-, 5-, and 6-phase machines operated at full load.

In terms of the frequency of the forcing function that is input to the mount system, at a given rotor speed the 6-phase machine will introduce torque ripple at twice the frequency as the 3-phase machine. If one compares the acoustic noise of the 6-phase machine at a given rpm, with the noise produced by the 3-phase machine at twice the given rpm, it is seen that there is a difference of approximately 15-20 dB. This is consistent with difference in amplitudes of the respective forcing functions (0.1-0.2 Nm to 0.8-1.4 Nm). Comparing the acoustic noise of the 6-phase machine at a given rpm, with that of the 5-phase at 6/5 the given rpm, one finds a difference of 4-5 dB, which is consistent with an amplitude that differs by 30%. Therefore, the results shown in Fig. 3 correlate well with expected performance.

### III. COMPARISON OF OUTPUT PERFORMANCE

To provide a basis for comparing the output current of the 3-, 5-, and 6-phase machines, it is convenient to represent the coupling of the rotor to stator windings through back-emf, which is shown on each of the stator windings in Fig. 1 and Fig. 4. The average output current of the rectifier is a function of the back-emf on the stator windings, the commutating inductance (labeled  $L_c$ ), and the battery voltage.

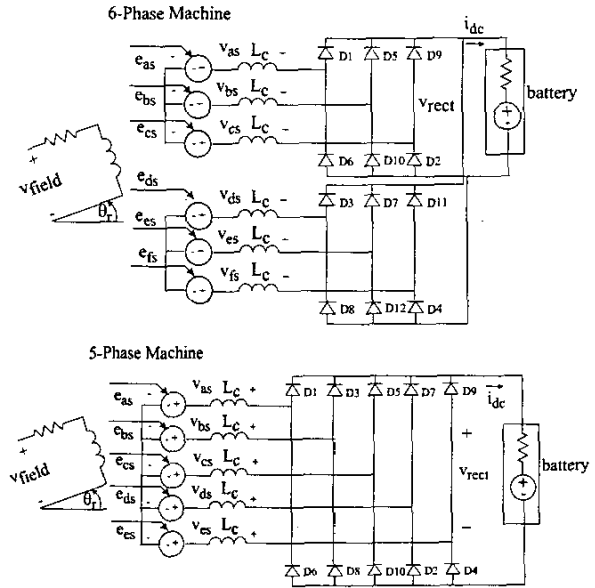

Figure 4. 6-phase and 5-phase charging systems.

In general, winding harmonics, coupled with permeance harmonics due to stator slots and rotor saliency lead to a back-emf with significant harmonic content. Although important for evaluating acoustic noise, to compare the output of the machines/rectifiers it is convenient to neglect harmonics and assume each of the machines has a phase- $a$  back-emf of the form

$$e_{as} = e \cos(\theta_r), \quad (8)$$

where the amplitude  $e$  is a function of field flux linkage and rotor speed.

As conduction begins, the switching of each of the rectifiers is a function of the back-emf waveforms and is consistent with the numbering of the diodes shown in Figs. 1 and 4. If one assumes equal back-emf amplitudes for the three machines, the cut-in speed where conduction begins (the line-to-line emf exceeds the battery voltage) is lower for the 5-phase machine. Specifically, the 6-phase machine is constructed as two 3-phase machines offset by 30 electrical degrees. Therefore, the line-to-line emf of the 3- and 6-phase machines is found from the vector sum of two phases

displaced by 120 degrees, which is equal to  $\sqrt{3}e_{as}$ . The line-to-line emf of the 5-phase machine, in contrast, is found from the vector sum of two phases displaced by 144 degrees, which is equal to  $1.902e_{as}$ . Thus, for a given speed, one would expect a line-to-line emf that is roughly 10% higher for the 5-phase machine compared to the 3- and 6-phase machines. In theory, this leads to a cut in speed that is roughly 10% lower for the 5-phase machine. However, the influence of slotting and saturation both play a role in the respective cut-in speeds.

For a given number of rotor poles and stator slot/pole/phase, the 5-phase and 6-phase machines will have 5/3 and twice the number of slots as the 3-phase machine, respectively. When evaluating the impact of this on stator to rotor flux linkage, Carter's coefficient provides a starting point. For the geometry studied, the resultant Carter coefficients are shown in Table 1.

TABLE 1: CARTER'S COEFFICIENT FOR 3-, 5-, AND 6-PHASE MACHINES.

3-phase	$K_{cl} = 1.2$
5-phase	$K_{cl} = 1.4$
6-phase	$K_{cl} = 1.6$

These values were calculated assuming similar slot openings and stator inner diameters for each of the designs. Comparing values, the impact of the additional slots is clear; the flux linkage for the 5- and 6-phase machines will be reduced compared to the 3-phase machine. However, it is noted that in typical automotive applications, the machine operates over a wide range of magnetic operating points. At lower speeds, the magnetic circuit is highly saturated, while at higher speeds it is much less so. The assumptions used to derive Carter's coefficient are weakened as the iron operates further in saturation.

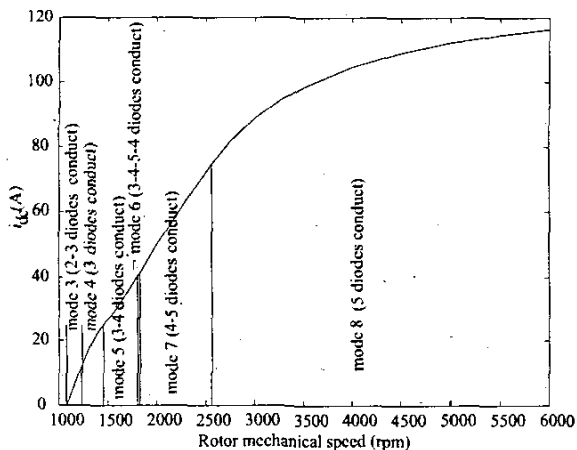

Figure 5. Operational modes of 5-phase machine/converter.

As the rotor speed increases above cut-in, the effect of the source inductance is significant. To illustrate, the modes of the 5-phase machine/converter with a battery load are shown in Fig. 5. From the figure it can be seen that between rotor

speeds of 1060-6000 rpm, there are 8 distinct conduction patterns of the rectifier. At speeds between 1060 and 1076 rpm, a sequence of 0-2 diodes are conducting (mode 1); at speeds between 1076 and 1079 rpm, a sequence of 0-2-3-2 diodes are conducting (mode 2). These modes are not shown due to their short durations. As the rotor speed increases more diodes conduct and above 2563 rpm, 5 diodes are always conducting. The effect of the source inductance on the 3- and 6-phase machine/converters is similar, although they each have distinct modes of conduction.

Analytically deriving closed-form expressions for the output current of the respective systems in each of the conduction modes is very challenging. Average-value models of a 3-phase source/rectifier with a battery load have been derived assuming the stator phase currents are continuous [12]. Average-value models of 3- and 6-phase machine/converters with current-source loads have been derived for a single mode of operation [13,14].

In lieu of average-value expressions, the results of a detailed-simulation are used to consider system behavior. For the simulation a somewhat simplified model of the machines is used. Specifically, to derive the model of the 3-phase machine, it is assumed that the stator is wound using concentrated windings (1 slot/pole/phase). To derive the self- and mutual-inductances only the fundamental component of the airgap flux density is used, the effects of MMF and stator slot harmonics are neglected. The stator winding leakage inductance is calculated from the slot geometry of the machine. The effect of  $d$ -axis saturation is included in the model using a compensation factor to adjust values of magnetizing inductance [11].

To model the 5- and 6-phase machines, the back-emf and magnetizing inductance obtained from the model of the 3-phase machine at each operating point are used. Specifically, the values from the 3-phase machine are multiplied by the ratio of Carter's coefficient of the 3-phase machine to that of the 5- and 6-phase machine to generate the respective 5- and 6-phase machine parameters. The stator leakage inductance for each machine is calculated from the respective slot geometry. It is recognized that the 5- and 6-phase machines have distinct saturation curves. The purpose of using the 3-phase data to generate 5- and 6-phase machine parameters is to assess the accuracy of using the ratio of Carter's coefficient to compare the performance of the three machines. The simulated performance of the simplified machine models are shown in Fig. 6.

From Fig. 6 it is seen that the simulations predict the 5-phase machine will have a higher output current than the 6-phase machine over a majority of the speed range. In addition, at speeds below 3000 rpm, the 5-phase machine is predicted to have a lower output current compared to the 3-phase machine. It is also noted that the 5-phase machine has a lower cut-in speed compared to the 6-phase machine, but slightly higher compared to the 3-phase machine.

To observe the behavior of the actual machines, the measured output current of the three systems is shown in Fig.

7. From Fig. 7 it is shown that the 5-phase machine does have a lower cut-in speed relative to the 3-, and 6-phase machines. In addition, the 5-phase machine provides increased output current over a majority of the speed range. Comparing simulated and measured results it is shown that the 3-phase measured/simulated responses are in very good agreement over the entire speed range. In contrast, neither the 5- nor 6-phase measured results compare favorably to simulated results at lower speeds. They agree more favorably at higher speeds. This is due to the effective airgap used in the models. At low speeds, where the machines operate in heavy saturation, using the ratio of the respective Carter coefficients to predict relative performance is not particularly accurate. At higher speeds, where a machine more closely approximates a linear magnetic system, the correlation of the models to test data is much closer.

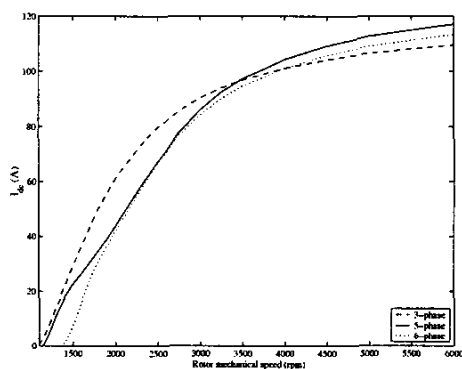

Figure 6. Simulated response using simplified machine models.

The results from the simplified models of the 5- and 6-phase machines indicate that predicting the output performance using lumped-parameter models requires operating-point-dependent parameters for each respective machine. Alternatively, numerical tools such as finite-element or magnetic-equivalent may be used.

#### IV. COMPARISON OF COST

In comparing the 5- and 6-phase machines, the 5-phase concept offers some advantages in terms of product performance as well as manufacturability that translates to lower cost. For one, the 5-phase is comprised of fewer slots. This helps not only the cost but also the machine performance. A 5-phase machine, wound with one slot/pole/phase requires five stator slots per pole whereas a 6-phase machine with one slot/pole/phase requires six slots per pole. For machines of an equal pole count, a 6-phase machine has 20% more coils and stator slots. This equates back to manufacturing cost in that more coils must be wound for the 6-phase machine, adding labor over the 5-phase machine baseline for the insertion of additional slot liners, winding and inserting of the additional coils, termination of the

additional coils, testing of the additional phase, and added complexity of tracking an additional set of leads through the manufacturing process until lead termination. From the product side, any additional part or operation offers the possibility of impacted reliability in that the additional part can fail or the process can be faulty. The additional manufacturing operations addressed reduce the product reliability as do the two additional diodes required for the 6-phase system.

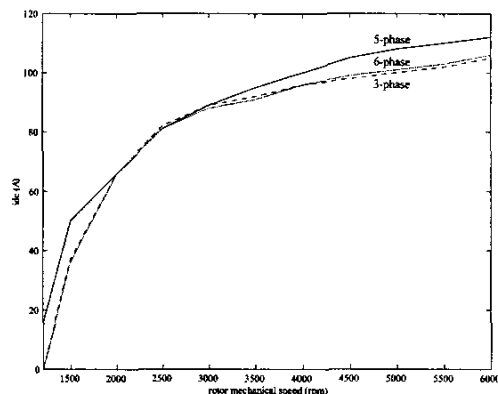

Figure 7. Measured output current as a function of rotor speed for 3-, 5-, and 6-phase machines.

The added slots of the 6-phase also present possible performance drawbacks. As shown in the previous section, the flux will drop as a result of the larger effective airgap. An additional concern of the added slot count is the increase in eddy current losses on the unlaminated rotor pole pieces. While complex to accurately calculate, these are attributable to permeance variations in the stator surface resulting in a flux ripple at the stator slot frequency. Given the 17% higher slot frequency of the 6-phase machine, one can expect the rotor surface losses to increase by 20-37% depending upon the depth of penetration of the slot harmonic flux.

If a continuous assortment of diode current ratings were available, one could select a diode for the 6-phase with 5/6th the current rating of the 5-phase generator. In practice, this is not the case, and one is usually forced to use diodes of the same rating for each machine, given the current requirements vary by only 20%.

#### V. CONCLUSIONS

In this paper, it is shown that the acoustic output of a 5-phase automotive generator compares favorably with that of a 6-phase machine and is much lower than that of the 3-phase machine with identical volumes. In addition, the output current produced by a 5-phase machine is, in general, 6-8% higher. Comparing the performance and manufacturing cost it is concluded that the 5-phase machine is a competitive alternative to 6-phase machines when mitigation of acoustic noise is of importance.

## VI. REFERENCES

- [1] S. Kusase, K. Banzi, S. Hayashi, "Alternating current generator having a plurality of independent three-phase windings," U. S. Patent 5,122,705, June 16, 1992.
- [2] C. Holley, D. Willyoung, "Stator winding systems with reduced vibratory forces for large turbine-generators," *IEEE Transactions on Power Apparatus and Systems*, vol. 89, no. 8, November-December 1970.
- [3] E. Fuchs, L. Rosenberg, "Analysis of an alternator with two displaced stator windings," *IEEE Transactions on Power Apparatus and Systems*, vol. 93, no. 6, pp. 1776-1785, November-December 1974.
- [4] R. Nelson, P. Krause, "Induction machine analysis for arbitrary displacement between multiple sets of windings," *IEEE Transactions on Power Apparatus and Systems*, vol. 93, no. 3, pp. 841-848, May-June 1974.
- [5] M. Abbas, R. Christen, T. Jahns, "Six-phase voltage source inverter driven induction motor," *IEEE Transactions on Industry Applications*, vol. 20, no. 5, September-October 1984.
- [6] E. A. Kingshim, "High phase order induction motors, part 1- description and theoretical considerations and part 2- experimental results," *IEEE Transactions on Power Apparatus and Systems*, vol. 102, pp. 47-53, January 1983.
- [7] E. Ward, H. Harer, "Preliminary investigation of an inverter fed 5-phase induction motor," *Proceedings of the IEE*, vol. 116(B), pp. 980-984, June 1969.
- [8] H. Toliyat, L. Xu, T. Lipo, "A five-phase reluctance motor with high specific torque," *IEEE Transactions on Industry Applications*, vol. 28, no. 3, May-June 1992.
- [9] P. Krause, O. Wasynczuk, S. Sudhoff, *Analysis of Electric Machinery*, IEEE Press, 1995.
- [10] H. Bai, S. Pekarek, R. Krefta, *et al*, "Analytical derivation of a coupled circuit model of a claw-pole machine with concentrated stator windings," *IEEE Transactions on Energy Conversion*, vol. 17, pp. 32-38, March 2002.
- [11] H. Bai, S. Pekarek, R. Krefta, *et al*, "Including the Effects of Saturation in a Coupled Circuit Model of a Claw-Pole Machine," in submission to *IEEE Transactions on Energy Conversion*.
- [12] V. Caliskan, D. Perreault, T. Jahns, J. Kassakian, "Analysis of three-phase rectifiers with constant-voltage loads", *30<sup>th</sup> Annual IEEE Power Electronics Specialists Conference*, vol. 2, 1999.
- [13] S. Sudhoff, O. Wasynczuk, "Analysis and average-value modeling of line-commutated converter-synchronous machine systems", *IEEE Transactions on Energy Conversion*, vol. 8, no. 1, pp. 92-99, March 1993.
- [14] S. Sudhoff, "Analysis and average-value modeling of dual line-commutated converter-6-phase synchronous machine systems", *IEEE Transactions on Energy Conversion*, vol. 8, no. 3, pp. 411-417, Sep. 1993.