Masters Theses

Student Theses and Dissertations

1961

Underground methods of working coal

Hemendra Nath Datta

Follow this and additional works at: https://scholarsmine.mst.edu/masters_theses



Part of the [Mining Engineering Commons](#)

Department:

Recommended Citation

Datta, Hemendra Nath, "Underground methods of working coal" (1961). *Masters Theses*. 2775.
https://scholarsmine.mst.edu/masters_theses/2775

This thesis is brought to you by Scholars' Mine, a service of the Missouri S&T Library and Learning Resources. This work is protected by U. S. Copyright Law. Unauthorized use including reproduction for redistribution requires the permission of the copyright holder. For more information, please contact scholarsmine@mst.edu.

T1319

W 2548

UNDERGROUND METHODS OF WORKING COAL

BY

HEMENDRA NATH DATTA

A

THESIS

submitted to the faculty of the
SCHOOL OF MINES AND METALLURGY OF THE UNIVERSITY OF MISSOURI
in partial fulfillment of the work required for the

Degree of
MASTER OF SCIENCE,
MINING ENGINEERING
Rolla, Missouri
1961

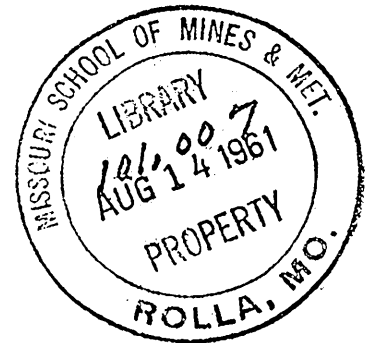

Approved by

(Advisor)

R. J. Benzenowski
A. Legendre

Ray E. Morgan
W. H. Christian

ABSTRACT

"Underground Methods of Working Coal" is the subject of this thesis. It is the purpose of this investigation to summarize all the mining methods under various conditions of working.

The underground methods of mining have been classified under three headings; viz., (a) Room and Pillar, (b) Longwall and (c) Horizon Mining. The conditions suitable for the applicability of each system and their relative merits and demerits are fully discussed.

The principles of the design of the workings of both room and pillar and longwall systems to have effective roof control in the area of the workings are pointed out.

Distinct and separate phases of development work in room and pillar, longwall and horizon mining are considered involving the layout of panels and development headings.

Finally, a large number of different methods of extraction in all the systems of mining under various conditions are given with the aid of suitable illustrations.

ACKNOWLEDGEMENT

The author wishes to express his indebtedness to Professor R. F. Bruzewski, his advisor, for his guidance and assistance in critically reviewing this presentation. He also wishes to express his sincere thanks to Dr. G. B. Clark, Chairman of the Department of Mining Engineering for providing all the facilities of the Department, and to those other members of the departmental staff who assisted in connection with the preparation of the thesis.

The scholarship offered by International Cooperation Administration for the Graduate study in this country is gratefully acknowledged.

TABLE OF CONTENTS

	Page
I. INTRODUCTION.....	1
II. COAL MINING METHODS.....	7
Surface Mining.....	7
Underground Mining.....	8
Room and Pillar System.....	9
Conditions suitable for room and pillar system.....	9
Advantages of room and pillar system.....	10
Disadvantages of room and pillar system...	11
Longwall System.....	12
Conditions suitable for longwall system...	12
Advantages of longwall advancing system...	14
Disadvantages of longwall advancing system.....	14
Advantages of longwall retreating system..	15
Disadvantages of longwall retreating system.....	16
Horizon Mining.....	16
Conditions suitable for horizon mining....	16
Advantages of horizon mining.....	16
Disadvantages of horizon mining.....	17
Factors Influencing the Choice of Method.....	18
III. MINE LAYOUT AND DESIGN.....	21
Strata Behavior.....	21
Behavior of Coal Pillars.....	25
The Design of Mine Workings.....	26
Room and pillar.....	26
Roadways with pillars giving full support.	27

	Yield-pillar technique.....	29
	Pillars for partial extraction.....	30
	Mechanized room and pillar workings.....	32
	Longwall workings.....	34
	Effect of Mechanization.....	37
	The Influence of Cleat.....	44
	Shaft Sites and Design.....	46
IV.	MINE DEVELOPMENT.....	50
	Opening the Mine.....	50
	Room and pillar and longwall mining.....	50
	Horizon mining.....	60
V.	EXTRACTION METHODS.....	70
	Room and Pillar Workings.....	70
	Thin seams.....	70
	Moderately thick seams.....	81
	Thick seams.....	104
	Suggested methods of pillar extraction.....	116
	Longwall Advancing System.....	118
	Opening out of longwall faces.....	123
	Handgot longwall faces.....	127
	Mechanized longwall faces.....	129
	Longwall Retreating System.....	149
	Horizon Mining System.....	153
	Face development in flat measures.....	153
	Face development in semi-steep and steep measures.....	160
	Sequence of extraction in flat measures....	160
	Sequence of extraction in semi-steep and steep measures.....	165
VI.	SUMMARY AND CONCLUSIONS.....	171

LIST OF FIGURES

Figures		Page
1	Maximum pressure arch set up in Longwall or other wide workings.....	24
2	Layout of narrow workings giving size of pillars.....	24
3	Layout of narrow workings in thin seams.....	28
4	Narrow workings showing Yield-Pillar technique.....	28
5	Failure of Yield-Pillar technique if the yield-pillar is too wide.....	28
6	Plan and elevation of yield-pillar workings in thick seam.....	31
7	Plan and elevation of yield-pillar workings in thin seam.....	31
8	Mechanized Room and Pillar workings using Yield-Pillar Technique.....	33
9	Design of Advancing Longwall workings.....	35
10	Design and layout of Longwall faces.....	35
11	Design of Retreating Longwall workings.....	38
12	Convergence Records and Prop Loads: Wood props supporting roadhead girders.....	42
13	Convergence Records and Prop Loads: Hydraulic props supporting roadhead girders..	43
14	Rooms driven at various angles to the main cleat.....	45
15	Mine workings with two main development headings.....	52
16	Mine workings with three main development headings.....	52
17	Mine plan showing layout of main and panel entries.....	54
18	Plan of development headings using crawler mounted cutter and loader, electric drill and face conveyors.....	55
19	Development of main entries by Continuous Miner.....	56

20	Development of panel entries by Continuous Miner.....	58
21	Main and panel entries in Advancing Longwall workings.....	59
22	Working a seam by Horizon system.....	61
23	Plan and section showing the network of roadways in any horizon.....	61
24	Location of main horizons in relation to seam sequence.....	66
25	Typical layout for a single seam horizon system.....	68
26	Layout of panels in Room and Pillar workings	
27	showing different methods of pillar extrac-	
28	tion.....	72
29		
30	Extraction of pillars on diagonal line of face.....	74
31	Extraction of pillars on step-diagonal line of face.....	74
32	Mining Plan - room panel using bridge units includes driving pairs of rooms off both sides on retreat.....	78
33	Plan of extraction in a thin seam.....	79
34	Plan of Room and Pillar workings in thin seam with Continuous Miner.....	80
35	Roof support plan for Continuous Miner workings.....	81
36	Detailed plan of rooms using Continuous Miner	82
37	Plan of Room and Pillar workings having rooms 22 feet wide and 315 feet long.....	83
38	Plan of Room and Pillar workings.....	84
39	Extraction of pillars on diagonal line in Room and Pillar workings.....	86
40	Layout of panels in Room and Pillar workings.	87
41	Sequence of extraction of pillars in Room and Pillar workings.....	88

42	Layout of panels and method of extraction of pillars in Room and Pillar workings.....	90
43	Loading station and track layout.....	92
44	Plan showing sequence of extraction of pillars by Continuous Miner.....	93
45	Sequence of cuts in roadways with Continuous Miner showing support system.....	95
46	Plan showing sequence of extraction of pillar by Continuous Miner.....	96
47	Method of extraction in Room and Pillar workings in steep seam.....	98
48	Method of extraction of pillars in a moderately pitching seam.....	100
49	Method of extraction of pillars in a highly pitching seam.....	102
50	Method of working steep seams with "breastings" on the strike.....	105
51	Method of extraction of pillars at shallow depth.....	106
52	Mining method in a seam pitching at 23°.....	108
53	Mining method in a seam 28 feet thick with	
54	hydraulic stowing.....	110
55	Mining method in a seam 28 feet thick with	
56	hydraulic stowing.....	112
57	Mining method in a seam 28 feet thick with	
58	hydraulic stowing.....	114
59	Methods of extraction of pillars at shallow	
a, b, c	depths.....	117
60	Methods of extraction of pillars in deep mines.....	119
61	Method of opening a Longwall face.....	124
62	Method of opening a Longwall face by wide-work.....	124
63	Method of opening a Longwall face on the rib-side of former workings.....	124

64	Sketch plan showing the method of forming coal faces by cross-gate extension.....	126
65	Plan and section of hand-got Longwall face...	128
66	Plan showing varying angles of cross-gates...	130
67	Layout of single unit faces.....	130
68	Layout of double unit faces.....	130
69	Arrangement of cross-gates on mechanized faces designed to reduce the length of haulage roads.....	133
70 a,b	Layout of Longwall face by conventional method.....	134
70 c	Layout of Longwall face by conventional method.....	135
71 a,b	Layout of Longwall face by continuous method.....	137
71 c	Layout of Longwall face by continuous method.....	138
72	General arrangement and method of support on panzer face.....	140
73	Mine plan using Dosco Continuous Miner.....	141
74	Layout of a 500 feet longwall face with Dosco Miner.....	143
75	Plan and section showing Advancing Longwall method with sandstowing.....	145
76	Longwall face in steep seams in Horizon system.....	147
77	Longwall face in steep seams in Horizon system.....	148
78	Opening out a panel for Longwall Retreating system.....	150
79	Retreating Longwall face.....	150
80	Layout of a Longwall panel using a Coal Planer.....	152
81	Layout of a face using Coal Planer.....	154
82	Coalface development in flat measures.....	155

83	Layout of Longwall faces to the rise.....	157
84	Layout of Longwall faces to the rise.....	157
85	Layout of Longwall faces to the rise.....	159
86	"Saw blade" and "Stepped" type Longwall faces in steep seam.....	159
87	Different methods of sequence of extraction of three coal seams between two horizons....	162
88	Different methods of sequence of extraction of three coal seams between two horizons....	162
89	Different methods of sequence of extraction of three coal seams between two horizons....	162
90	Different methods of sequence of extraction of three coal seams between two horizons....	162
91	Sequence of extraction of three seams between two horizons.....	164
92	Layout of working faces in semi-steep measures between two horizons.....	164
93	Layout of working faces in steep measures...	167
94	Layout of working faces in steep measures...	168
95	Layout of working faces in steep measures...	168

CHAPTER I

INTRODUCTION

All of the early civilizations, with the exception of China, developed in warm countries where only very limited quantities of coal exist and its demand is minutely limited. For this reason, references to coal in ancient literature are very meager. It is generally agreed, however, that coal was known to be used on a commercial scale by the Chinese long before it was so used in Europe. Its actual use as fuel in England was known during the Roman occupation in the first century A.D. However, as domestic fuel, coal was not widely introduced in England until the first half of the fourteenth century.

Coal mining in Germany probably began about the tenth century A.D. Agricola mentions coal as being in general use in Europe early in the sixteenth century, but its development there was probably later than it was in England.

The first reference to coal being found by Europeans in the United States was in 1672 and since about 1720 it was known to be mined continuously.

The early methods of mining were primitive and limited in extent due to lack of tools and equipment. Also, people had no experience in the science and art of mining. At first, only those seams which were outcropping were exploited by quarrying; an early and crude version of the present day system of opencast mining. When the coal became too deep for quarrying, it was penetrated underground by short tunnels

and then robbed laterally until the condition became too dangerous to work. In this way the coal was extracted following the outcrop. The coal was cut by wooden picks which were shod or tipped with iron and by iron wedges. It was carried to the surface on the backs of women, boys and girls, and later ponies were employed underground for drawing the loads.

In areas where coal occurred at a depth too great for quarrying, extraction was effected by driving small "bell-pits" or shafts. Because explosives were unknown for breaking rocks or coal until about the beginning of the seventeenth century, they used a method of heating the rock by fire and then quenching with water to cause spalling. This manner of breaking rock was known to man even during the stone age when people used to mine flint for making weapons. The coal from the pitbottom was worked by belling out as much as possible without supporting the roof, after which the pit was abandoned and another sunk nearby.

The coal was hand dragged and carried to the surface until about the fourteenth century when windlasses worked by hand, similar to those used for drawing water from wells, were introduced for hoisting the coal in baskets. Later, gins worked by horses were introduced. This method of winding was continued until about the nineteenth century although water wheels were used to raise coal in some places.

Since the early days of coal mining, both blackdamp and firedamp explosions were frequent due to bad ventilation.

It was an old practice to burn out the firedamp by igniting it with a light on a pole which was carried by a fireman who was wrapped in rags, saturated with water, and who used to lie on the floor while he extended his light towards the face. This was a recognized method of dealing with firedamp for a long period.

In the early stages of mining, only natural ventilation was used. Furnaces for ventilation, to augment the flow of air resulting from natural drafts, were used as early as 1732, and stoppings to regulate the course of air were used in 1759. The location of the furnace was at the foot of the upcast shaft thus giving rise to a chimney effect which increased the flow of air through the workings. Reference of a mechanical ventilator is found as early as the fifteenth century but its real use, in general, was not to be found before the beginning of the nineteenth century.

Drainage from underground workings was always a problem. Chain-bucket pumps, operated by horses, were introduced about the middle of the seventeenth century. Invention of the steam engine and its application to mine pumping, about the beginning of the eighteenth century, helped to solve the pumping and winding problems to a great extent.

As the demand for coal grew due to increased industrialization, haphazard working of mines underground had to be abandoned. The earliest systematic method of underground workings was the "Room and Pillar" which was universally adopted. But in most of such mines the largest percentage

of coal was taken from the first workings, that is, the pillars were made small and rooms large. As a result, much coal was lost in the pillars. Gradually, by experience, mining engineers learned the safer methods of exploitation. In the present day practice, about 15 to 35 percent of coal is taken during development work so as to make the pillars stand for subsequent extraction with minimum of loss. Room and Pillar mining is very flexible and can give very high outputs. It is decidedly the best method which can give highest production per man-shift (O.M.S.). In the United States, the majority of coal comes from Room and Pillar work and gives the world's record overall output of more than 5 tons per man-shift.

The Longwall method was probably introduced in the latter part of the seventeenth century. This method is found useful in deep mines where strata pressures are high and control of roof can be easily achieved. Most of the coal in England and on the Continent, where the present working depth is great, is worked by Longwall. This method gives a much lower overall output per man-shift compared to the Room and Pillar mining. In this case, it is about 1 to 1.5 tons. Although the overall O.M.S. value is poor in Longwall, this is probably the only method by which seams at great depth can be exploited. Due to lower output per man-shift in Longwall, the mining engineers are trying to devise means by which Room and Pillar mining can be safely adopted in deep mines. Some progress has been made on this

line and probably it may not be impossible in the future to apply successfully the Room and Pillar mining in deeper mines.

Since the introduction of the steam engine in eighteenth century, the growth of railroads and manufacturing industries increased the demand for coal. As a result, the coal mining industry grew faster. Production of coal as well as consumer goods increased. These could be exported to other countries from which raw materials for the manufacturing industries could be imported. These industrial developments, during the last century had built England into one of the most powerful nations of the world.

The coal reserves in the United States are the richest of any nation; amounting to 30 percent of the world's known total. In the field of energy supply where coal competes with alternate sources of power, or heat, coal is by far the major contributor of British Thermal Units to United States energy consumption. This is also true with any other industrial nation. In 1954, coal contributed (measured in B.t.u. content) 39.8 percent of the total consumption of energy in the United States; petroleum products, 27.3 percent and natural gas, 27.2 percent. So essential and substantial is the contribution of coal that it obviously forms the foundation on which is erected the entire United States pattern of B.t.u. input and consumption. Coal has powered America's industrial revolution from the beginning. It is the yardstick which other fuels use to measure their abilities to compete.

At the present day, systematic development of workings by both Room and Pillar and Longwall methods is practiced in a scientific way. The great demand for coal and the extensive size of mines led to the development of various kinds of mining machinery that can replace manual labor. At the present time, the coal winning and transportation have been completely mechanized in many mines which can thus produce a continuous flow of coal from the face to the surface.

Ventilation, due to increased depth and extensive workings, is not a great problem now. Very large mechanical ventilators on the surface and auxiliary fans underground are used to provide fresh air to every working place and to dilute and render harmless the inflammable and noxious gases. In deep mines, where the strata temperature is very high due to geothermic gradient, or where weathering of the exposed surfaces of coal occur, air conditioning is usefully employed to deal with the situation.

Dust control problems are being tackled scientifically by systematic sampling of the air and evaluating and by taking measures in preventing the formation and dissipation of dusts. Multistage turbine pumps are now available which can pump large quantities of water at high heads. Lighting standards underground have been considerably improved due to the introduction of electric cap lamps and other fixed lamps.

CHAPTER II

COAL MINING METHODS

Surface Mining

Surface mining is the simplest and the cheapest of all mining methods. There are no problems of support, ventilation or lighting. All work is done in open air and, hence, it is called opencast or open-pit mining.

Opencast mining can be applied to thick coal seams either outcropping or occurring under a very shallow cover. It involves the complete removal of the overburden and then the extraction of the coal so exposed. This method can be applied up to a certain economic depth beyond which the cost of mining will be prohibitive. This economic depth varies from one country to another depending upon the degree of mechanization and the cost of labor involved.

Recently, since about 30 years ago, a new technique has been developed by which coal can be converted into gas insitu. This method is known as underground gasification. It may be defined as the process whereby an injected gaseous mixture is made to react, by burning and destructive distillation, with solid coal bed so as to produce a gas containing the maximum of useful fuel products. The chief aim of gasification is to produce cheap fuel, but certain types of operations can produce gases suitable for chemical synthesis.

Surface mining methods will not be considered in detail as this thesis is written on underground methods of working only.

Underground Mining

As the seams go deeper or the thickness of overburden increases, mining cannot be profitable by the opencast method. In such cases, an approach to the seam is made by shafts, inclines or adits. When the seam is reached, the actual mining method employed depends upon depth and local conditions. The method chosen may be Room and Pillar, Longwall or Horizon system.

As stated previously, the earliest system of working a coal mine was Room and Pillar which is also variously known as Bord and Pillar, Stoop and Room and Pillar and Stall. The Room and Pillar system involves the driving of a series of narrow headings which are parallel to each other and connected by cross-headings so as to form pillars for subsequent extraction, (Figure 40) either partial or complete, as geological conditions or the necessity for supporting the surface permit.

The Longwall system was developed later and is gradually replacing the Room and Pillar system in deeper mines. There are two categories of longwall system viz., (a) Longwall Advancing and (b) Longwall Retreating.

Longwall Advancing system involves the extraction of the panel of coal to be worked by advancing the face forward on a broad front, leaving behind the roadways serving it and which are supported by packs of stone or other artificial filling in the area of extraction (Figure 21). These roads are then maintained in condition to provide for haulage and ventilation.

The Longwall Retreating system is a combination of Room and Pillar and Longwall Advancing systems. Headings are driven in the coal, as in the case of room and pillar mining, but large pillars are formed. These pillars are then extracted, working back towards the roadway from which the headings had been started (Figure 79). When this system can be adopted, it may combine the advantages secured by each of the other two systems, and in favorable conditions, avoid some of their disadvantages.

The Horizon Mining system involves the development of different horizons in stone by a network of level roadways and the extraction of pitching seams of coal between horizons by longwall method. The coal worked in between a pair of horizons is transported through the lower of the two horizons (Figure 25).

Room and Pillar System

Conditions Suitable for Room and Pillar System

The depth at which the pressure of the superincumbent strata reaches nearly the crushing strength of coal, may be considered as the limiting depth for room and pillar mining. In some seams, longwall may have to be adopted earlier than in other seams due to variation of the strength of coal. Generally, at depths greater than 2000 ft., longwall mining is usually adopted.

Driving entries and rooms in thick seams is very easy, cheap and convenient. In thin seams, however, tramming is difficult and conveyors may have to be used or costly brushing of roof or floor of haulage entries is required.

Seams under villages, towns, valuable buildings, roads, railways, rivers, seas, fire areas, water-logged goafs, etc. are worked by room and pillar system; leaving pillars for the support of the top. If total extraction is desired, stowing or packing has to be resorted to.

In faulted areas, longwall is not usually suitable and room and pillar system is adopted.

As it is difficult to dispose of the dirt bands in room and pillar mining, clean seams free from dirt bands are suitable for the adoption of room and pillar method.

Room and Pillar method is also suitable in seams where roof and floor are strong to enable the roof to stand well in the bords and to prevent the floor from lifting. The coal should also be sufficiently strong to stand in the pillars without crushing.

Advantages of Room and Pillar System

If the room and pillar system, roadways are supported by solid pillars. Thus the roads can be maintained in safe conditions without using much artificial supports.

Intensive mechanization can be adopted in room and pillar system and output per man-shift at the face is greater than in longwall method since all operations are productive. Labor is better utilized in room and pillar system since its unproductive use in packing is eliminated.

The relatively smaller size of the group of workers encourages team spirit. Supervision and maintenance of discipline are facilitated and the progress of work can be readily checked shift by shift.

In room and pillar work, the area is proved in advance by driving headings. In longwall, on meeting a fault the whole output is lost. In room and pillar, on knowing the direction of the fault, the rest of the headings may be accordingly driven, i.e., initial planning may be modified. This is also possible in longwall retreating system.

Disadvantages of Room and Pillar System

The deeper the seams, the greater is the difficulty of working by room and pillar due to higher strata pressure. In this method, the rate of advance is sometimes slow because development takes greater time. This is of course not true for well mechanized room and pillar workings where 2 or 3 cycles per shift can be obtained.

There is danger of crush during depillaring due to higher stresses of the superincumbent strata acting on the pillars. Also, the percentage of extraction is less. Ventilation is more difficult; especially in gassy mines. In long headings where auxiliary or booster fans have to be installed, ventilation will be more costly.

A large number of roadways have to be driven and maintained in room and pillar work and their maintenance is also costly. In thin seams, a large amount of deadwork is needed for keeping the large number of roads open by dressing the roof and/or floor.

For the same output, a large number of working places are required in room and pillar work compared to longwall system. This makes supervision difficult. If the mine is extensive,

hauling lengths are greatly increased involving increased haulage cost. In this system, the need of constant flitting of the machinery from place to place is great. So the number of idle hours of machinery in room and pillar will be greater than that of longwall.

There is difficulty in extraction of contiguous seams especially during depillaring operations (without packing). However, this difficulty is reduced by working the seams in descending order.

The roof control is comparatively difficult during extraction of pillars when no packing is adopted. If pillars are weak, additional stresses may be thrown on the pillars in the depillaring area which may cause overriding of pillars or premature collapse. If some pillars are left in the goaf, the goaf will not settle quickly and this will produce an undulating subsided surface.

The money invested is not always quickly returned. In room and pillar work, winning of coal is cheap and gives maximum profit during extraction of pillars. This means a longer period has to be waited until the development is complete.

In highly mechanized mines, a high standard of planning and organization and a larger staff of skilled technicians is needed to achieve maximum efficiency in mining operations.

Longwall System

Conditions Suitable for Longwall Working

The system is very suitable in thin seams. Under these conditions, the gate roads are made large enough by ripping

the roof or dinting the floor for efficient haulage and ventilation and, further, the material so obtained can be used in packs. It is also the best method for use at great depths from the roof control point of view. The property should be comparatively free from faults, dykes and other geological disturbances, however.

Seams containing a number of dirt bands can be worked efficiently by longwall method as these bands can be picked out underground or efficiently separated on the surface. The separated material can be sent down or used for packing on the spot.

Seams having a tough roof which bends gradually when settling onto the packs instead of breaking heavily over large areas at intervals are suitable for longwall working. Seams having a weak friable roof can also be successfully worked by the longwall method as new roof is continually being exposed as the face advances, and is, therefore, more secure than roof which stands for some considerable time and has been broken up due to roof pressure.

Gassy seams are easier to work by longwall as there are few roadways and ventilation presents a little problem. Seams liable to spontaneous combustion can be efficiently worked by longwall provided that all the coal is extracted and the goaf is solidly packed.

Contiguous seams in close proximity can be more effectively worked by longwall as less disturbance is likely to be caused to adjacent seams than by room and pillar method.

Advantages of Longwall Advancing System

Full productive operations can be commenced in long-wall mining with comparatively little development work. Also, this method provides for the maximum degree of extraction from the seam. Longwall working requires a concentration of men and, therefore, large outputs can be drawn from relatively small working areas.

Subsidence is uniform over the working area and its rate and amount can be regulated within limits by the method and quality of packing.

Disadvantages of Longwall Advancing System

Maintenance of roadways for haulage and ventilation through goaf is more costly due to use of additional unproductive labor and material required for such work.

If sufficient packing material is not available underground, it has to be transported from the surface which requires more unproductive labor and a transport system.

If packs are not properly made, there is chance of leakage of air through the packs which may cause sluggish ventilation at the face and may also cause spontaneous heating in the goaf if coal is left in such areas.

In longwall advancing system, a rigid cycle of operations is to be followed. Multiple coal-getting shifts can not be obtained as in room and pillar system.

Faults or other geological disturbances can not be proved in advance, so outputs are hampered when they are met with.

For some distances behind the working face, the roadways are in moving ground. In such conditions, uninterrupted working of roadway belt conveyors is more difficult to ensure.

When the boundary is reached, the salvage of all support materials and the removal of all machinery must be expedited if serious losses are to be avoided. This requires a large salvage staff.

Advantages of Longwall Retreating System

The area is proved in advance. First the boundary is reached during development and then the face recedes towards the shaft. Hence, planning can be modified if faults are met with. The gate roads are maintained in solids and, therefore, they are well supported. As the ground is stable, the roadway conveyor will be better installed, less liable to damage and therefore more reliable.

In advancing the gate roads, as the boundary is reached, the longest length of conveyors, haulage tracks, etc. are required, but in retreating, these length go on decreasing, thus reducing the transport cost accordingly.

Packing goaf may be avoided completely. But if there are contiguous seams, packing may be required. The labor required for unproductive work of packing can be reduced. Hence, the number of productive shifts can be increased.

No stable in the gate road is required as in longwall advancing method since galleries are already driven, thus saving in labor and explosive.

There is no leakage of air. So ventilation is better effected.

Disadvantages of Longwall Retreating System

The initial development work is extensive and hence very costly. Full production and large output is delayed.

The roadway conditions within a few hundred feet of the face are not good since roof pressure due to subsidence acts in side roads also. So a strict vigilance is required. However, these gate roads are in better condition than those of longwall advancing system where roads are maintained in the goaf.

Horizon Mining

Conditions Suitable for Horizon Mining

Contiguous and pitching seams are suitable for horizon mining system. This method may also be adopted when large outputs are wanted at great depth where transport is a bottleneck in conventional single level mining operations.

Advantages of Horizon Mining

There is greater flexibility available in the choice of a main road haulage system. Since the main roads are level, locomotive haulage is an economical and effective method of coal haulage underground. Where man-riding is necessary, it is easily accomplished with locomotive haulage without additional equipment. Under similar conditions locomotive haulage is more efficient than rope haulage. The flexibility of locomotive the haulage system makes it far superior for the transportation of large quantities

of output to a single point and allows quick and punctual return of empty mine cars to the loading points inbye. Any alteration in the capacity of the main haulage can be dealt with easily in a locomotive haulage system by reducing or increasing the number of locomotives or mine cars in use.

This method is favorable where stowage material, supports and other supplies have to be brought to the face in large quantities.

Ventilation is more efficient as the main intake and main return airways are completely separated. Since it is not necessary to provide air-crossings at frequent intervals, leakage of air is minimized. The intake air is kept almost free from methane, since the roadway is in stone.

The horizon mining system allows the possibility of working several seams simultaneously.

Disadvantages of Horizon Mining

There is greater initial cost brought about by the driving of expensive drifts in rock and longer time is required for initial development before coal winning is commenced.

This system requires a certain minimum reserve of coal available, varying with conditions but sufficient to amortise the cost of stone drifting and cover interest charges. This minimum reserve varies according to the net proceeds, capital expenditure required and the geological conditions, and may be estimated at approximately 10 million tons per level.

Factors Influencing the Choice of Method

If the pitch is less and the seam is outcropping or occurs under a shallow cover, quarrying can be done profitably for a great distance in the direction of the dip. For quarry work, the property should be extended along the strike. If the pitch is more than 1 in 5, even though the seam is outcropping, it cannot be worked by this method. After the economic limit of quarrying, the seam has to be worked by underground mining methods. As the depth increases, roof support becomes more and more difficult since pillars, after standing for some time, may crush or collapse due to heavy pressure of the superincumbent strata. At moderate depths, room and pillar method can be adopted where the pillars can stand well but at higher depths the pillars have to be made large in size and the rooms would be narrow. Consequently, the percentage of extraction in the first working, i.e., during development, would be very low and thus the development cost would be very high. Moreover, standing pillars may occur. In such cases longwall method will be the only alternative.

Moderately pitching seams can be worked by room and pillar method or by longwall method but when the pitch is too steep, horizon system of mining with longwall face will be very suitable.

Thick seams, if outcropping or occurring under a shallow cover, can be worked by opencast method up to economic

limit of working depth. Normally, thick seams are worked by room and pillar method because larger amounts of packing materials are not easily available for longwall work. In thin seams, either the roof or the floor of the main roads is brushed out and the brushing material can be used for longwall working.

Quality of the seam may also play an important part in the choice of the method of working. The physical property such as pronounced cleat, hard or soft coal will influence the strength of pillars and duration for which they can be allowed to stand. These properties influence production of slack coal and reduce the strength of pillars causing crush of pillars. Extraction of such pillars will become difficult if room and pillar method is adopted. The chemical property such as a seam liable to spontaneous combustion may require that the seam be worked by panel system or complete packing or stowing may have to be adopted.

The actual method of extraction and layout of workings, both in room and pillar and longwall, is greatly influenced by the roof and floor conditions.

If a low pitching thick seam is outcropping but is under a high ridge, it cannot be worked by opencast method due to heavy overburden although conditions are suitable for opencast mining. If due to geological disturbances a number of seams in succession are highly folded causing increase in pitch, horizon system of mining may be a very suitable method.

In deep mines where longwall system is adopted and sufficient packing material is not available, it may be

desirable to adopt retreating longwall instead of advancing longwall.

Longwall method of extraction of coal requires a steady market. Where demand of coal is fluctuating the room and pillar method can easily cope with the situation.

CHAPTER III

MINE LAYOUT AND DESIGN

Strata Behavior

When a coal seam is totally extracted over a considerably large area there will evidently be subsidence of the strata right up to the surface whatever may be the depth and thickness of the seam and the method of working. The effects of partial extraction may, however, be limited to movement of the strata. The extent of such movement is dependent on the width of excavation and the size of the coal pillars left in-situ. In coal measure rocks, i.e., the rocks associated with coal seams, the weight of the superincumbent strata is about 1 p.s.i. per foot of depth. So at great depths the weight will be greater than the carrying power of any practical form of artificial supports. Mining at great depths is, therefore, only possible because the greater proportion of the load due to the weight of the superincumbent strata over any excavation is transferred to the sides of the excavation as abutment loads. The object of strata control is to reduce the stresses in the working areas so the strength of the subsiding roof mass is conserved and breakage of the roof beds is minimized. The artificial supports reinforce natural pillars in order to control movement of the nether roof beds and to maintain space in the working areas. Control of the beds nearest to the seam has an important bearing on the behavior of the upper beds, but artificial

supports are inadequate to sustain the load due to weight of the overlying strata. It is, therefore, essential that workings should be so designed that concentration of main roof loads in working areas is avoided and provision is made for accommodation of concentrated abutment loads on coal pillars of adequate dimensions or, when necessary, in excavated areas but in such positions as to be clear of the roadways.

As soon as a roadway is driven in solid coal, the state of equilibrium of the strata is immediately disturbed due to the inability of the strata immediately above the excavation to maintain the weight of the superincumbent beds. The nether roof beds immediately above the excavation for some distance bend downward. The bending of the roof beds will cause the beds to sag away from each other. In this way they are no longer subjected to the weight of the higher rocks and they become distressed. The distressed strata will lie within an arch known as "pressure arch". The loads of the beds above the pressure arch are transferred to the solid pillars on each side of the roadway. These loads are called abutment loads of the pressure arch. If the width of the excavation is increased, the dimension of the pressure arch also increases until a width is reached greater than that which the higher beds are able to bridge. This width is called the width of maximum pressure arch. The maximum pressure arch set up around the solid perimeter of Longwall or other wide workings is shown in Figure 1. The width of maximum pressure arch varies with

depth but it is influenced by the prevailing strata conditions. Conditions of the gate roads in Longwall workings are generally good for a certain distance back from the face, beyond which the gate roads begin to be disturbed. As the face advances, this point of disturbance in the gate road also advances. This is an indication of the position of the back abutment of the pressure arch. The distance between the face and the position of the back abutment may be taken approximately as the width of the maximum pressure arch in the prevailing conditions.

From observations made on Longwall roadways, the following figures are given as conservative estimates of the width of the maximum pressure arch for various depths (48):

<u>Depth</u> <u>Ft.</u>	<u>Width of Max. Pressure</u> <u>Arch.</u> <u>Yd.</u>
400	40
600	50
800	60
1000	70
1200	80
1400	90
1600	100
1800	110

The main roof load can be transferred over a distance not exceeding the width of the maximum pressure arch, which thus provides a rough datum for the design of workings. Because of the possible influence of local strata conditions,

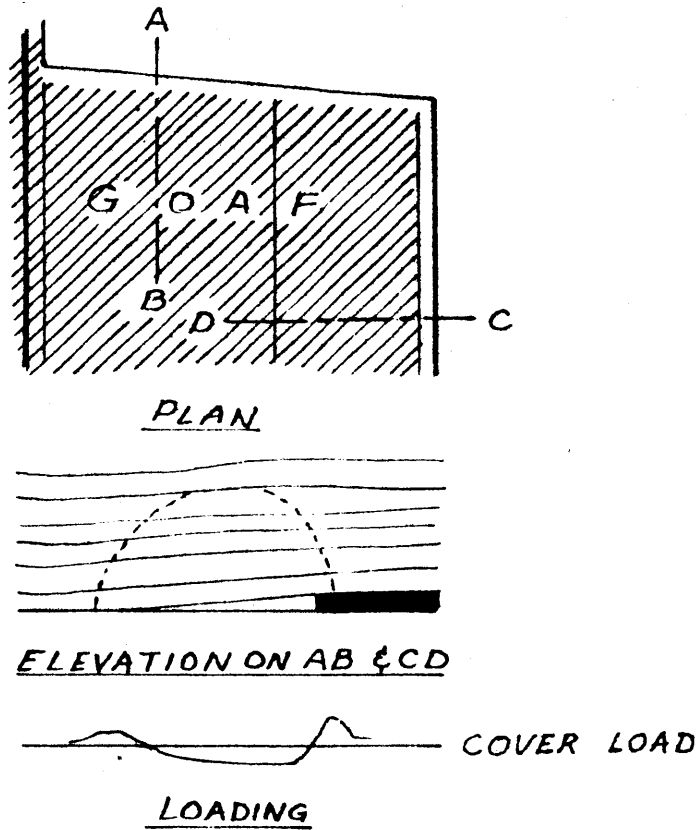
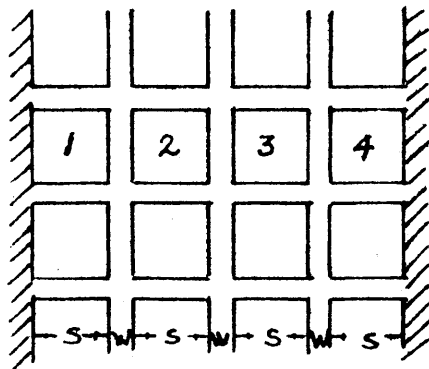

FIGURE 1 Maximum pressure arch
set up in Longwall or other wide workings (48)



$$S = \frac{M+W}{2} \text{ WHERE:}$$

S = LENGTH OF SIDES
OF SQUARE PILLARS.
M = WIDTH OF MAXIMUM
PRESSURE ARCH.
W = WIDTH OF ROADWAYS

FIGURE 2 Layout of narrow workings
giving size of pillars (48)

however, it is desirable to determine the individual pressure arch by direct observations. The figures given serve only as a general guide for design purposes pending actual ascertainment. For designing workings on this principle provision must be made for the accommodation of the abutment loads on coal pillars of adequate size or in excavated areas with positions which are clear of the roadways.

Behavior of Coal Pillars

It is known that the compressive strength of coal is infinite if there is complete lateral constraint. Coal has planes of natural weakness and when coal pillars are formed the sides of pillars are fractured and tend to move towards the excavated area. The friction between the roof and floor and the fractured coal opposes this movement and sets up lateral constraint which increases toward the center of the pillar. Thus, if the pillars are of sufficiently large an area near the center, it will be completely constrained and it will support any load which may be imposed. It is evident that a large coal pillar will carry a much greater load than a number of small pillars of the same total area. Similarly, a square pillar will carry a greater load than a rectangular pillar of the same area. (48)

The width of a pillar for a particular duty is a function of the maximum load which the pillar may have to carry and is therefore determined by the widths of the adjoining excavations. Observations have shown that a satisfactory width for a pillar between comparatively wide excavations (about three-quarters of the width of the maximum pressure

arch) is equal to the width of the excavations. It is deduced that a pillar as wide as the maximum pressure arch will withstand the abutment loads imposed by wide workings on both sides of the pillar, and that a pillar half as wide as the maximum pressure arch will withstand the abutment load imposed by wide workings on one side of the pillar.

The Design of Mine Workings

Room and Pillar

In Room and Pillar workings, the roads are narrow and pillars are large. The abutment loads on the coal pillars, due to driving of narrow roads, will therefore be small. This is true in the development stage. But after development when the extraction of pillars is started on the retreat, the pillars adjoining the goaf will be subjected to the forward abutment load of maximum pressure arch which spans the area and the back abutment load rests in the goaf. In this case, the width of the pillars should not be less than half the width of the maximum pressure arch under the prevailing conditions. Reference to the table on Page 23 will show that the width of the pillars increase from 20 yards at a depth of 400 feet to 55 yards at a depth of 1800 feet. This width is the actual width of pillar and not the distance from center to center. The most convenient pillar shape is a square but if rectangular shapes are made the shortest length should be one-half the width of the maximum pressure arch.

While pillars are being extracted, a straight line of face should be maintained to avoid local concentration of loads on the pillar. The strength of pillars should be conserved by avoiding splitting and, in deep mines, it is better to take slices from the sides of pillars which are in distressed zones.

Roadways with Pillars Giving Full Support

When roadways are driven in solid coal, the width of the supporting pillars should not be less than the mean of the width of maximum pressure arch and the width of a single roadway. Pillars of this width will be capable of carrying the loads imposed by the front abutment of the maximum pressure arch set up across the edge of wide goafs on each side of the roadways. Figure 2 shows the layout of narrow roadways and Figure 3 shows the layout in a thin seam where the roadways are made wide enough to provide space for packing the stone from the rippings. In both cases, pillars 2 and 3 can be reduced in size without causing damage to the roads provided the pillars 1 and 4, adjoining the goafs, have widths of the maximum pressure arch. In practice, all the pillars should have the width of maximum pressure arch in order to provide for the loads to be carried in the final extraction stage. An abutment zone situated upon solid coal tends to move forward in time and may cause damage to roads nearest to the goafs. For this reason, generally, two pillars are left between the outermost roads in the panel and the goafs in the case of main roadways which have to stand for a long time and especially at great depths.

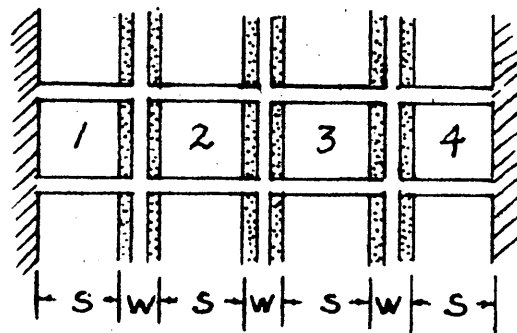

$$S = \frac{M+W}{2}, \text{ WHERE:}$$

S = LENGTH OF SIDES OF SQUARE PILLARS

M = WIDTH OF MAXIMUM PRESSURE ARCH

W = WIDTH OF ROADWAY EXCAVATIONS

FIGURE 3 Layout of

narrow workings in thin seams (48)

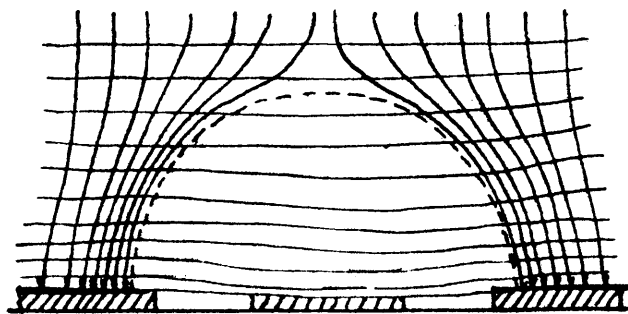

FIGURE 4 Narrow workings

showing Yield-Pillar technique (3)

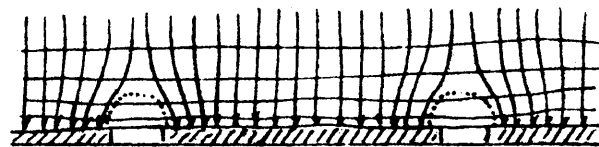

FIGURE 5 Failure of Yield-

Pillar technique if the yield-pillar is too wide (3)

Yield-Pillar Technique

In development headings at shallow depths, sufficiently wide roads seldom give trouble whereas in deep mines and especially when the depth is more than 800 feet even narrow roadways are difficult to maintain. This is due to the high concentration of abutment loads on the roadsides. To overcome this difficulty, a new method known as Yield-Pillar Technique has been developed. (3)

It has been seen by experiment in the Plessey Seam at a Northumberland Colliery in England (4) that if the length of a shortwall face for partial extraction is not more than three-quarters of the width of maximum pressure arch, the roof in the working area is relieved of its load and the main roof load is transferred to the sides of the excavation as abutment loads and stable conditions are maintained if coal pillars of a width equal to that of the excavation are left on each side.

Experiments have also shown that similar transference of loads occur when comparatively wide places, which are separated by coal pillars small enough to yield, are driven within limits fixed by the width of the maximum pressure arch. The very minute yield, which is necessary, will be afforded by bands in the coal, by the roof or the floor, without apparent change in the coal. The pillar must be strong enough to carry the residual load due to the strata within the pressure arch which is set up across the panel of roadways. When this pillar yields, the abutments of the

pressure arch of the wide place will rest upon the solid coal at some distance from the sides of the roadways at both sides of the panel as shown in Figure 4. When the pillar is too wide to yield, two independent pressure arches will be formed above the two roadways as shown in Figure 5. The smaller abutment loads do not result in the coal sides yielding to the same extent and the loads acting near the coal sides are sufficient to cause the roof to shear. The dimensions of the pressure arch set up across a panel of yield-pillar workings of less overall width than that of the maximum pressure arch will vary with the width of the panel and will generally be the same for a given width whatever the depth. The maximum width across a panel of yield-pillar workings must be less than the width of the maximum pressure arch under the prevailing conditions and solid coal barriers of a width adequate to sustain the imposed abutment loads must always be maintained on both flanks of the panel. A safe limit for the width across a panel is three-quarters of the width of the maximum pressure arch and the width of the barrier pillars on the flanks should not be less than the mean of the width across the panel and the width of the maximum pressure arch. The plans and elevations of Yield-Pillar roads in the case of thin and thick seams are shown in Figures 6 and 7, respectively.

Pillars for Partial Extraction

Where only partial extraction is desirable, pillars less than those in normal room and pillar practice may be

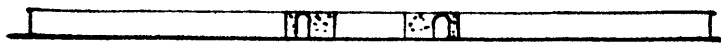
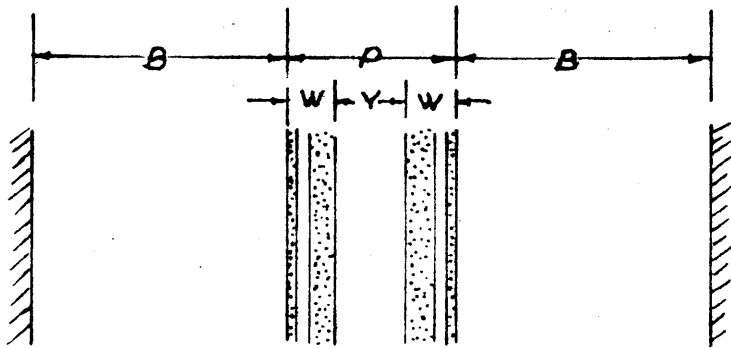

FIGURE 6

Plan and elevation of yield-pillar workings in thick seam (48)

W = WIDTH NECESSARY FOR ROADWAYS
 Y = WIDTH OF YIELD PILLAR.
 B = WIDTH OF BARRIER PILLAR &
 $= \frac{\text{WIDTH OF MAX. PRESS. ARCH} + P}{2}$
 P = NOT GREATER THAN $\frac{3}{4}$ WIDTH OF
 MAXIMUM PRESS. ARCH.

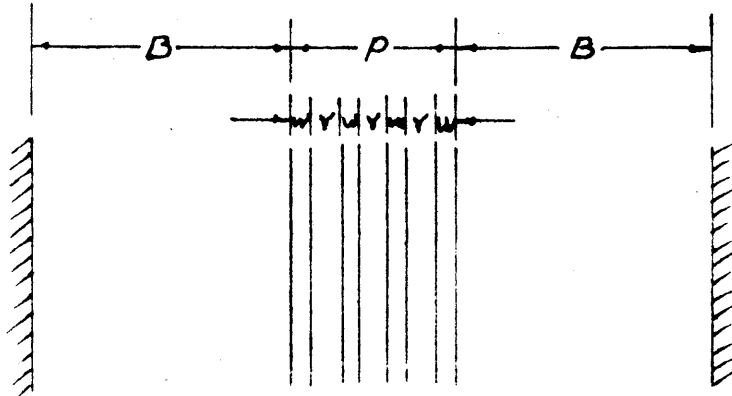

FIGURE 7 Plan and elevation of yield-pillar workings in thin seam (48)

formed. To depths of about 400 feet, approximately 50% of the coal can be extracted in this way without appreciable subsidence of the surface. At greater depths, however, the percentage of extraction will be much less. Because the pillars formed by the extraction of such a small proportion of coal are designed to carry only the normal cover load, they would fail progressively if for any reason a concentrated load had to be carried and, therefore, care must be taken not to form large areas of such pillars if it is possible that full extraction may be required later.

The extent of surface subsidence may be limited by "crushed-pillar" practice in which pillars small enough to crush are formed on retreat; generally, by splitting larger pillars, which were formed in advancing.

Mechanized Room and Pillar Workings

Mechanized room and pillar workings have hitherto largely been limited to depths of about 400 feet, but development of the yield-pillar technique will allow this method to be used in the deeper seams. Figure 8 shows room and pillar workings for full extraction where three rooms are driven from each entry. In order to keep loads in the working area below the normal cover load, the width across all rooms working from a pair of entries must not exceed three-quarters of the width of the maximum pressure arch. The pillars between the two rooms of each room entries form the yield-pillars. (48)

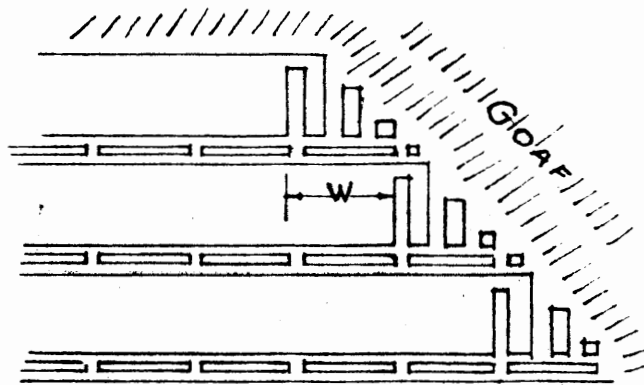

FIGURE 8

Mechanized Room and Pillar workings
using Yield-Pillar Technique (48)

Longwall Workings

In longwall workings a short face is sometimes driven ahead in the solid coal to provide opening out of other longwall faces as shown in Figure 9. If this short face is not more than three-quarters the width of the maximum pressure arch under the prevailing conditions, a transverse pressure arch will be formed across the excavation. The roof loads in the excavated area will be much less than the normal cover load due to the abutment loads of the pressure arch resting on solid coal on the flanks.

When the longwall faces are opened from the flanks, a longitudinal pressure arch is formed with its front abutment resting on the solid coal in advance of the face and the back abutment behind in the goaf. If the longwall face is started right from the flank of the roadways leading to the short advancing longwall face, the back abutment of this longitudinal pressure arch will cause damage to these roadways. The damage can be prevented by leaving coal pillars of adequate size between the face on the flanks and the short excavation. These pillars have to carry one abutment load of the transverse pressure arch which spans the short excavation and the back abutment load of the maximum pressure arch of the face on the flank. An adequate width of pillar to accommodate these loads will be not less than half the width of the short winning face, plus half the width of the maximum pressure arch formed on the longwall face on the flank. Pillars of this size can be extracted without

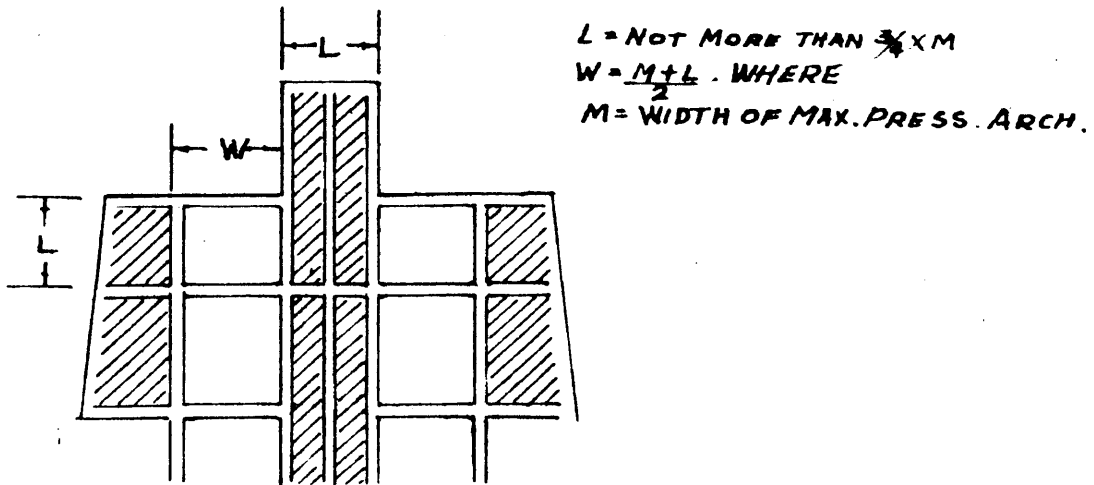

FIGURE 9 Design of Advancing Longwall workings (48)

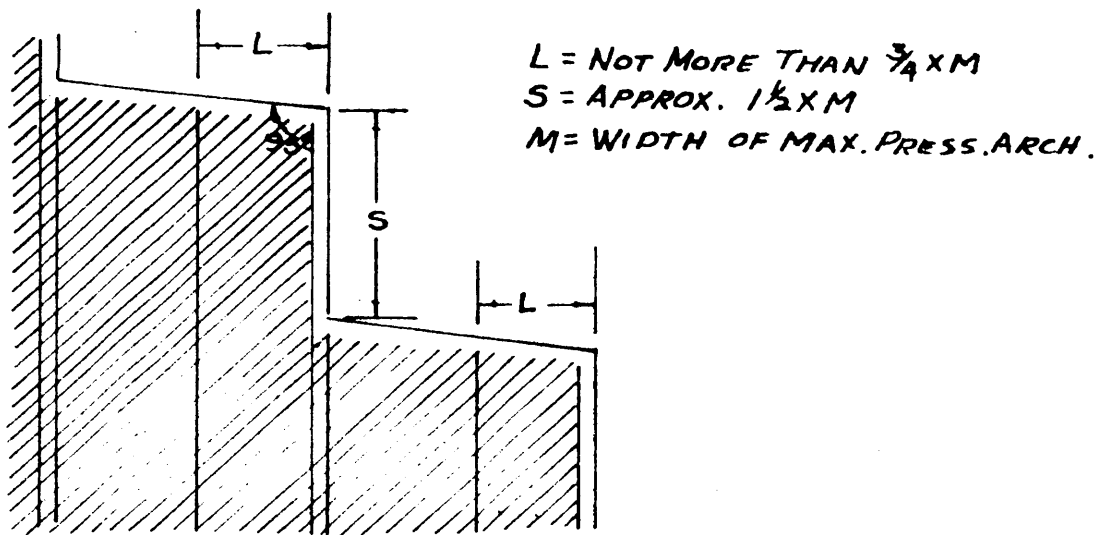

FIGURE 10 Design and layout of Longwall faces (48)

difficulty as their strength is ample to sustain the abutment loads which are imposed. (48)

Owing to the support afforded across the corners at the rib sides of longwall faces, the front abutment pressure zone is closer to the face near the rib side and may tend to invade the face area. This often results in roof damage at the fast ends of the faces. The stronger the coal and the smaller the abutment pressure the more likely this is to occur. It has been found that damage from this cause can be prevented by maintaining an angle of about 95° between the face and the rib side, as this reduces the support across the corner and causes the abutment zone to move further onto the coal.

The back abutment of the pressure arch across the face always has an adverse effect on the gate roads behind advancing faces. This can often be reduced by providing "double packs" which reduce the load on the roadway by concentrating the pressure at some distance from the road sides. If the back abutment of the transverse pressure arch across the rib side also acts on a gate road, maintenance difficulties will be increased. This can be reduced when the distance between the rib side and gate road is not more than three-quarters of the width of the maximum pressure arch under the prevailing conditions as shown in Figure 10.

When a number of longwall faces are advancing in series, roof trouble is likely to occur on the following faces if the back abutment of the leading face is in line

with the front abutment of the following face. This can be avoided by keeping the length of the step between the two faces substantially greater than the width of the maximum pressure arch as shown in Figure 10.

In the Retreating Longwall method, trouble from back abutment is eliminated, but the front abutment may have an adverse effect on the roadway in the solid coal in advance of the face. The development of the Yield-Pillar Technique will help in averting this trouble if roads are driven in pairs separated by suitable yielding pillars, as shown in Figure 11. Since the main load is transferred to the flanks as the yield-pillar roadways are driven, it can be expected that the front abutment pressure set up by the retreating face would not act on the yielded pillar zone, but would be deflected to the flanks and would intensify the pressure in the abutment zones already established by the transverse pressure arch across the two roads. It is quite probable that the chain pillars would give effective support to the rib-side road left for the working of the next face.

Effect of Mechanization

The effect of mechanization on the design and layout is considerable from the viewpoint of planning and roof control. For example, the faces in longwall workings where a power loading-machine is used must be laid out on the best line and at the optimum length for the particular machine which is to be used. If, for instance, a machine can cut

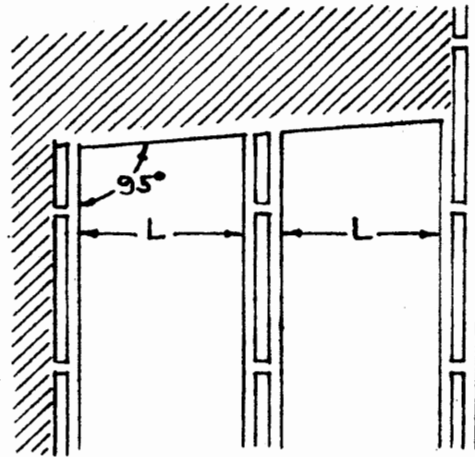

CHAIN PILLARS: WIDTH SUITABLE TO RESULT
IN YIELD:

(WIDTH OF MAXIMUM PRESS ARCH +
WIDTH ACROSS ONE PAIR OF FACE
ENTRIES)

L = NOT LESS THAN

2

FIGURE 11

Design of Retreating Longwall
workings (48)

and load at a consistent rate of 25 yd. per hour and such factors as travelling time and haulage facilities can give six hours of actual working time at the face, it is a great wastage of machine potential to use a face only 100 yards long instead of the optimum 150 yards. Planning can also minimize the amount of road construction and other ancillary work which has to be done within a district. It may be possible to use retreating panels or a combination of advancing and retreating panels.

All power loading machines in longwall workings require a good roof under which to operate and full value can not be obtained from the machine unless this is provided. Each machine requires for its actual working area a certain amount of unsupported ground and the roof control, in general, must be such that this space can remain open for the time required by the machine without roof falls interfering with the work. The actual space required over the machine is, however, far from being the only aspect of roof control problem. Quick erection of permanent supports with quick load-bearing characteristics and as close as possible to the coal face is perhaps the most important point. Where power loading machines are used, supports of adjustable length, which can be easily and quickly handled are almost essential if the erection of supports is to keep pace with the rate of travel of the machine. Hydraulic self-advancing supports have been recently developed which can keep pace with the rate of travel of the face. By

the use of this method of support, it has indicated that not only the total roof/floor convergence is minimized but also the differential lateral movement between roof and floor is considerably reduced. It is felt that a wide application of this method of support will increase productivity on faces where high speed coal-getting machines are used.

One great advantage which power loaders possess over hand-working by conventional methods, from roof control point of view, is that no precutting is necessary. The machine and the operators work under newly exposed roof which has not been standing weakly supported by noggled coal for some hours or, at weekends and holidays, for some days. In conventional working, the distance from the really solid coal at the back of the cut to the front edge of the pack may be quite high. With some kinds of power loader such as Dosco Miner, this distance can be reduced to as little as 5 ft. and, when packing is completed, the face can be very snugly supported - a factor of special importance at weekends and holidays. (29)

It is known that the failure of a support system is often caused by the fact that the props are penetrating either the roof or the floor at a very low load thus allowing a considerable increase in the natural floor/roof convergence. It is possible to fit foot pieces to props in order to eliminate or minimize this penetration but there is, as yet, no formulae that can be applied so that a pattern and density of support could be arrived at which

would give the maximum resistance between roof and floor with a minimum of support settings.

For a long time it has been realized that the initial resistance offered by rigid supports was low even when such supports were erected with care. Consequently, bed separation is earlier and convergence is more resulting in hazards of roof failure. This is true whether it is a longwall face or at roadheads where ripping is done. In ripping lips, in addition to falls of ground due to earlier bed separation, there is the risk of shots igniting firedamp in breaks and such ignitions may extend to adjacent wastes via breaks and separation cavities. The development of yielding type of supports having high initial resistance provides a means of reducing roof convergence and the consequent bed separation (6).

Figures 12 and 13 show the effect on convergence and prop resistance when wood and hydraulic props, supporting roadhead girders, are used in a gate road beyond the ripping lip up to the face. Two sets of convergence recorders are used; one is set between the floor and the immediate roof, and one between the floor and some 12 ft. above the roof of the seam. It shows, that for the same period, the convergence is considerably reduced by the use of hydraulic props. The initial load, in case of hydraulic props, is about 7 tons and then rises to 22 tons at which the load remains constant whereas, in case of wood props supporting girders, the initial resistance is zero and the maximum load never remains

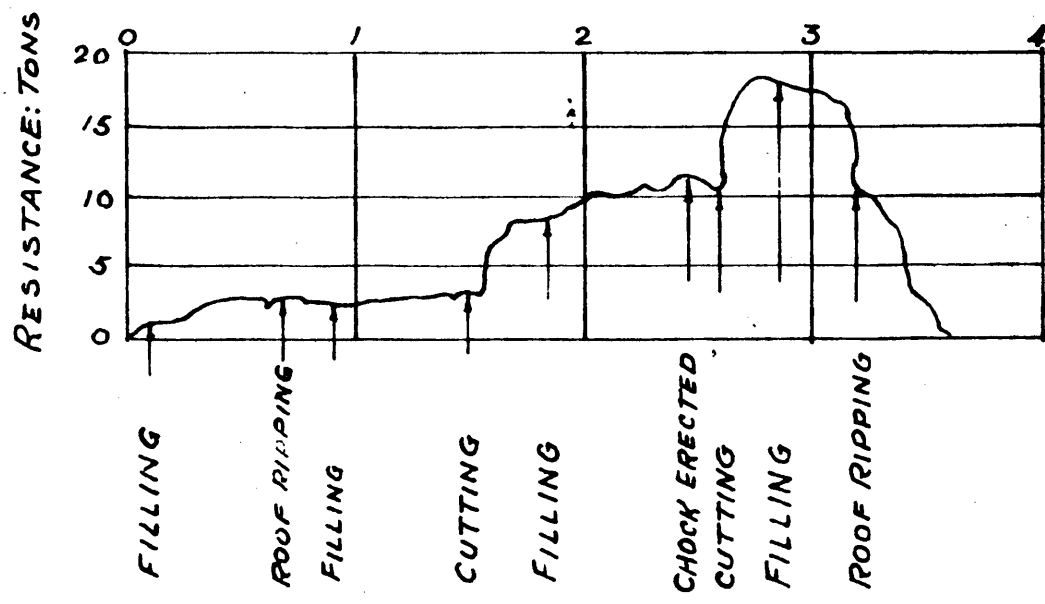
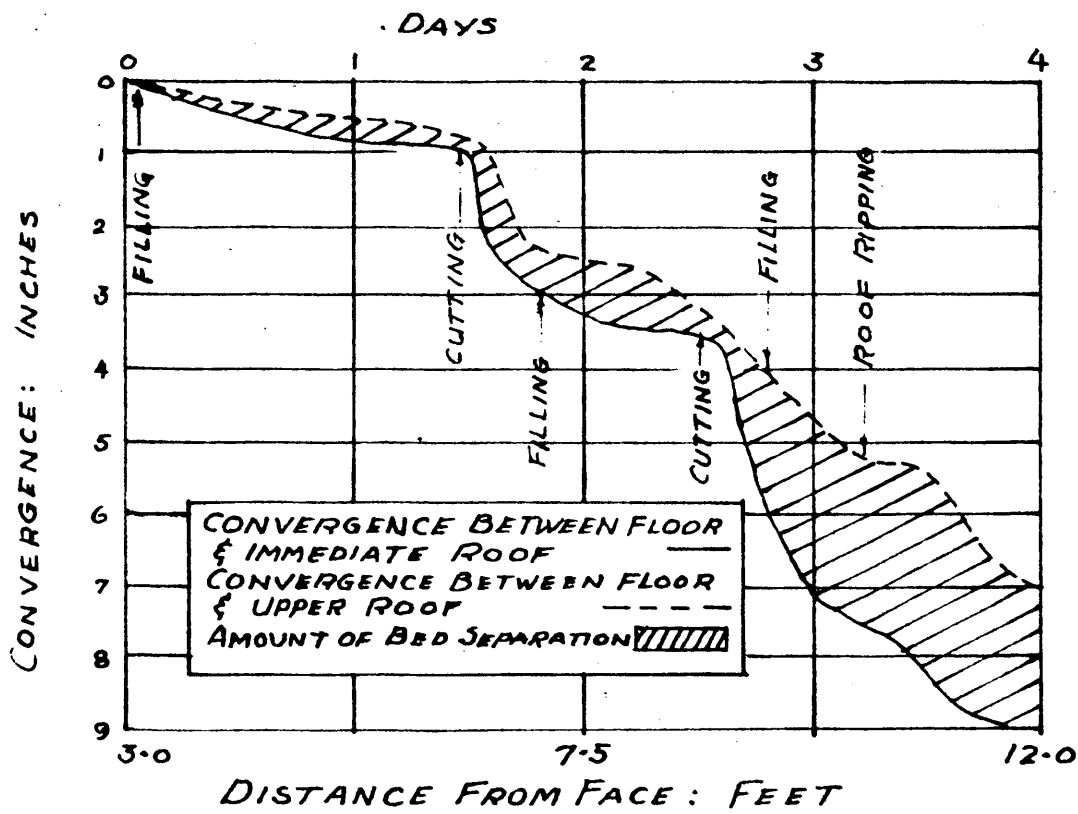

CONVERGENCE RECORDS AND PROP LOADS:
WOOD PROPS SUPPORTING ROADHEAD GIRDERS (6)

FIGURE 12

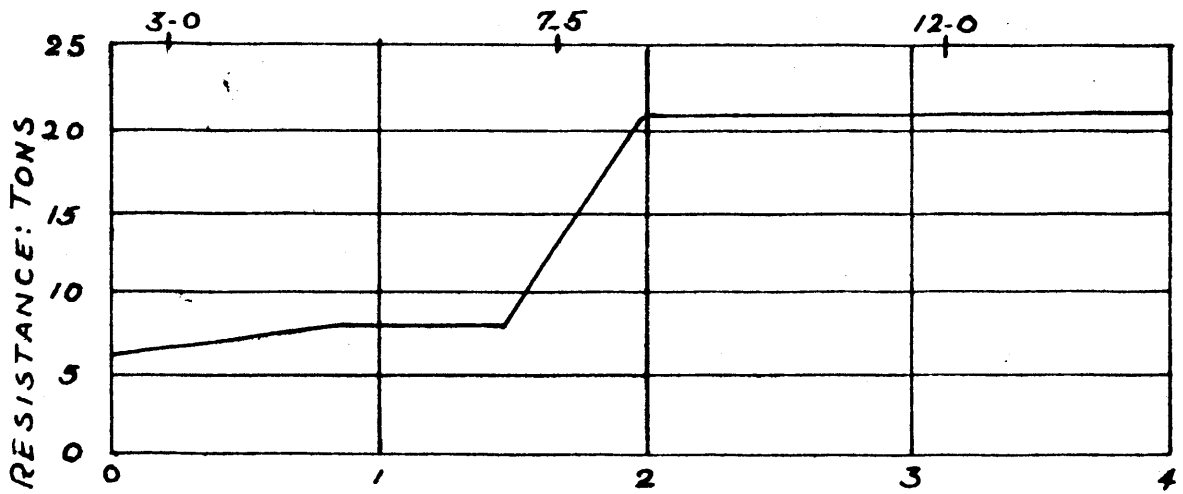
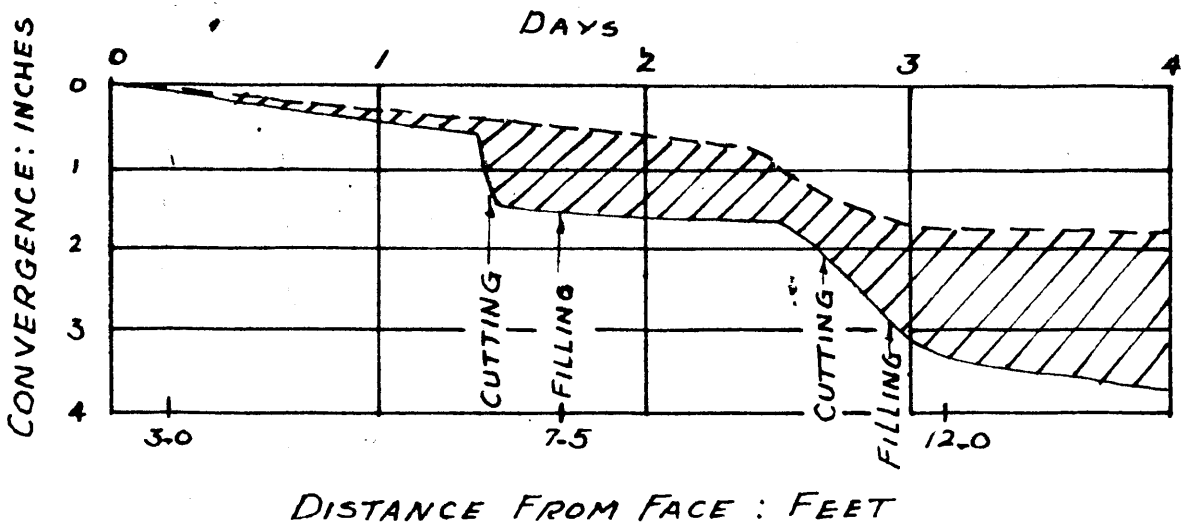

CONVERGENCE RECORDS AND PROP LOADS: HYDRAULIC
PROPS SUPPORTING ROAD HEAD GIRDERS (6)

FIGURE 13

constant. Thus it shows also the reliability of using hydraulic props to control the roof movements.

The Influence of Cleat

Cleat is a cleavage plane in coal. In most of the coal seams there are three planes of cleavage along which coal breaks in cubical blocks. There is the cleavage along the plane of stratification of the seam which is parallel to the roof and floor. At right angles to this plane of stratification two other cleavages are present, one is more pronounced than the other. The more pronounced one is called "face" or "bord" cleat and the less pronounced and irregular one is called "end" or "butt" cleat. Not only the coal seams but also certain surrounding strata bear the evidence of cleavage planes.

Figure 14 shows rooms driven at various angles to the main cleat and the names given to each type of room. In general, rooms are driven "face-on". That is, the face of the room is parallel to the face cleats. Coal worked in this way produces a larger percentage of lump coal and requires less undercutting and blasting.

In "long-horn" or "long-awn", the faces make an angle less than 45° with the face cleats. If the coal works too freely face-on, this method gives support to the ends of the coal while being cut. (24).

In "half-on" or "half and half" or "awn", the face makes an angle of 45° to the face cleats. This method is used when coal breaks just as well on either the face or butt cleats.

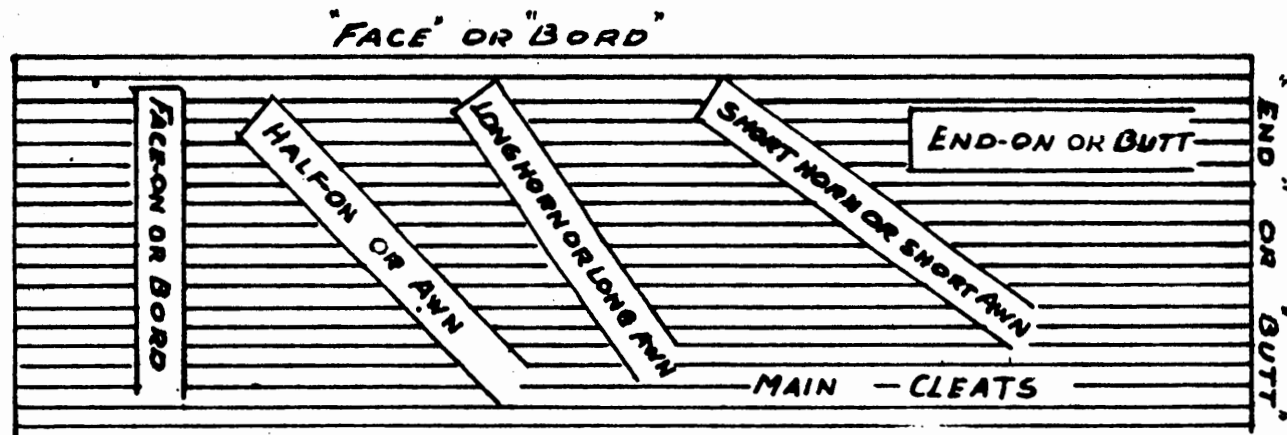

FIGURE 14

Rooms driven at various angles to the main cleat

In "short-horn" or "short-awn", the face makes an angle of more than 45° to the face cleats. This method is used when the end cleats are very pronounced.

In "end-on" or "butt-on", the face is at right angles to the main cleats. This method is used in coal under great pressure. It gives smaller percentage of lump coal than face-on work but allows greater control of the face.

In seams containing gas under pressure, if the rooms are worked "face-on", large volumes of gas will escape into the workings since it will be present in the cleats. This is dangerous from the safety point of view. Working "end-on" or "butt-on" will allow gas to escape slowly.

Shaft Sites and Design

Shaft sinking is a very costly part of the mining operations and in deep mines the capital expenditure in this phase of development might alone constitute over half of the total cost. Proper siting of the shaft in relation to the area to be developed is very important as it may effect the future success or failure of a mine. Mistakes in siting are usually associated with unforeseen underground conditions. Therefore, a thorough knowledge of the underlying seams and the nature of the rocks through which the shaft is to be sunk is essential before any planning or sinking operations are attempted.

The position of the shaft is dependent upon both surface and underground conditions. The surface influences

include (a) proximity to railway and access roads, (b) availability of sufficient water for power plant and washery, (c) availability of space for housing plants, buildings, offices, etc. on the surface, (d) adequate space for the disposal of debris and (e) availability of adequate power supply. Underground, the site must be considered with regard to the shape and size of the mine boundary, the presence of geological disturbances such as faults, folds, etc., and the amount and direction of the seam pitch. The nature of the overlying strata should be known to avoid sinking through strata which may require special methods of shaft sinking. If the seams are highly inclined and horizon system of mining is to be adopted, the site of shafts should be so chosen as to reduce the lengths of rock drivages to a minimum.

Ideally the center of the property may be the best site for shafts or inclines but other conditions may so outweigh such a choice that some other suitable site might have to be chosen. Experienced mining engineers must be able to utilize their judgements to select the best sites. There must be at least two shafts or outlets to any mine for the sake of ventilation and safety.

Inclined shafts are almost always rectangular, though if concrete-lined they may have arched roof. Where seams are outcropping the inclined shafts are generally driven along the floor of the seam and along the pitch. But if the seams are at shallow depth, inclined shafts may be

driven in rock. This facilitates haulage and permits uninterrupted transport of coal from the face to the surface. Under such conditions, however, a combination of vertical and inclined shafts may be driven depending upon prevailing conditions so that haulage can be effected through the inclined shaft and man-riding and upcasting can be effected through the vertical shaft. In deep seams the shafts are invariably vertical because they are the shortest and, consequently, the least expensive.

The vertical shafts may be circular, rectangular, square or elliptical in shape. Circular shafts are more commonly used in coal mining. They are especially desirable in deep mines, where heavy side pressures have to be resisted. For a given cross-sectional area the circular shafts present the least rubbing surface to the ventilating current. It is also best suited to sinking under difficult conditions and to the insertion of a water tight lining. Circular shafts can be sunk quicker than any other shape of the same cross-sectional area. But the greatest disadvantage of circular shaft is that the full area of the opening cannot be fully utilized as in the rectangular shafts which can be divided into several compartments. (28).

Rectangular shafts are extensively used in metal mines for sinking in rock. The rectangular section divides naturally into rectangular compartments with great economy of space. It requires less excavation for a given hoisting area and it is adopted to framed timber or steel support.

Square shafts are similar to rectangular ones but they are rarely used.

Elliptical shafts aim at combining the advantages of both circular and rectangular shafts. Elliptical section is stronger than rectangular and shares its space economy. It can be designed to have a concrete lining but it is difficult to keep plumb during sinking. Sometimes elliptical shafts can be modified to give straight sides and rounded ends which combine convenience of dividing into compartments with efficient air passages.

The size of the shafts should be carefully chosen. This will depend largely upon the desired output of the mine and the type of hoisting system, ventilation requirements, amount of water to be raised, character of the ground and unit costs of sinking and operating.

CHAPTER IV

MINE DEVELOPMENT

Opening the Mine

Careful planning is essential for proper mine development. Therefore, a comprehensive investigation and study of the configuration of the underlying seams by thorough prospecting and boring is first necessary and then, based on these results, the mining operations are planned in detail for maximum efficiency.

Room and Pillar and Longwall Mining

The shaft-bottom layout is most important. It serves as a link between passage through the shaft and transport in the underground workings. An efficient face organization can be maintained only if the underground haulage functions properly. The latter depends more on the shaft-bottom layout to absorb irregular surges imposed by the road transport than on the capacity of the hoist. The shaft-bottom has to operate as a buffer between the two entirely different transport systems and at the same time it has to link these systems together. This can be achieved by having a shaft-bottom of adequate storage capacity. Any stoppage, whether in the shaft or in the underground haulage system, should not be transmitted from one to the other before a certain period of time has elapsed. This period should be of ample duration to cover such stoppages as are likely to occur in normal working of a mine. This storage capacity depends upon the type of haulage adopted, the type

of hoist (skip or cage) and the desired output.

Adequate support for surface plant buildings and for the shafts themselves must be left in the form of a coal pillar to ensure that there is no ground movement in those areas during the period of normal mining operations. The shape and size of the shaft pillars depend upon the depth and pitch of the seams and, also, the area to be supported on the surface.

The number, size, direction and the gradient of the main development roadways from the shaft-bottom or drift entry depend upon the pitch of the seam, the type of mechanization employed during development work, the ventilation requirements, the nature of the roof and floor conditions and the layout and method of working of the districts of the mine and their interdependence upon the main roads. Previously, only two roadways, one for the intake and the other for the return air, were used. This is still practiced in many mines as shown in Figure 15. The more general present day practice, however, is to have a minimum of three headings; two for intake and one for return. This has become an essential safety measure resulting from underground fires in intake roadways. Such a layout is shown in Figure 16. In more mechanized mines the main development headings may range up to five or six where continuous miners are used for development purposes. In most of the continuous mining operations in United States the main and panel entries consist of 3 to 8 headings. Thus, development with

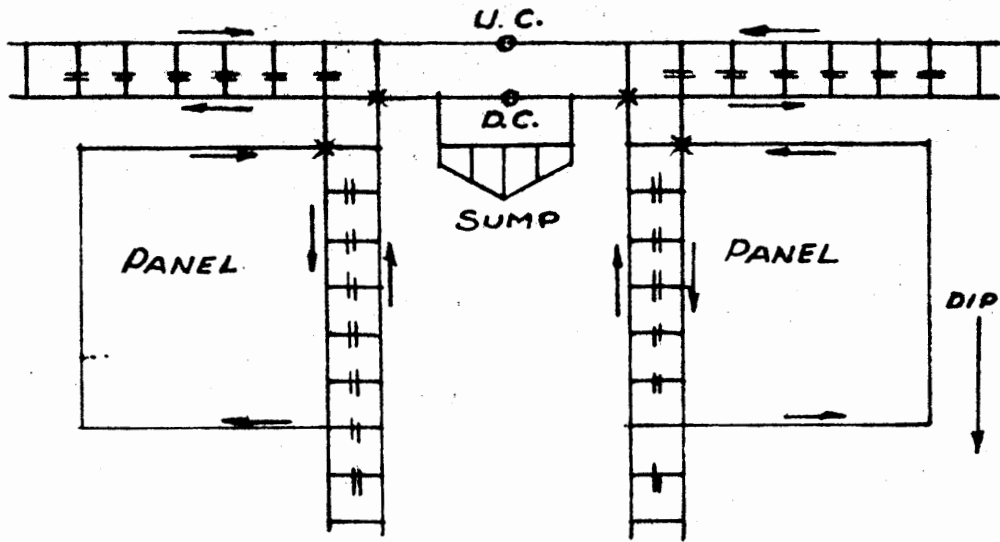

FIGURE 15

Mine workings with two main development

X = AIR CROSSING
 UC = UPCAST SHAFT
 DC = DOWNCAST SHAFT

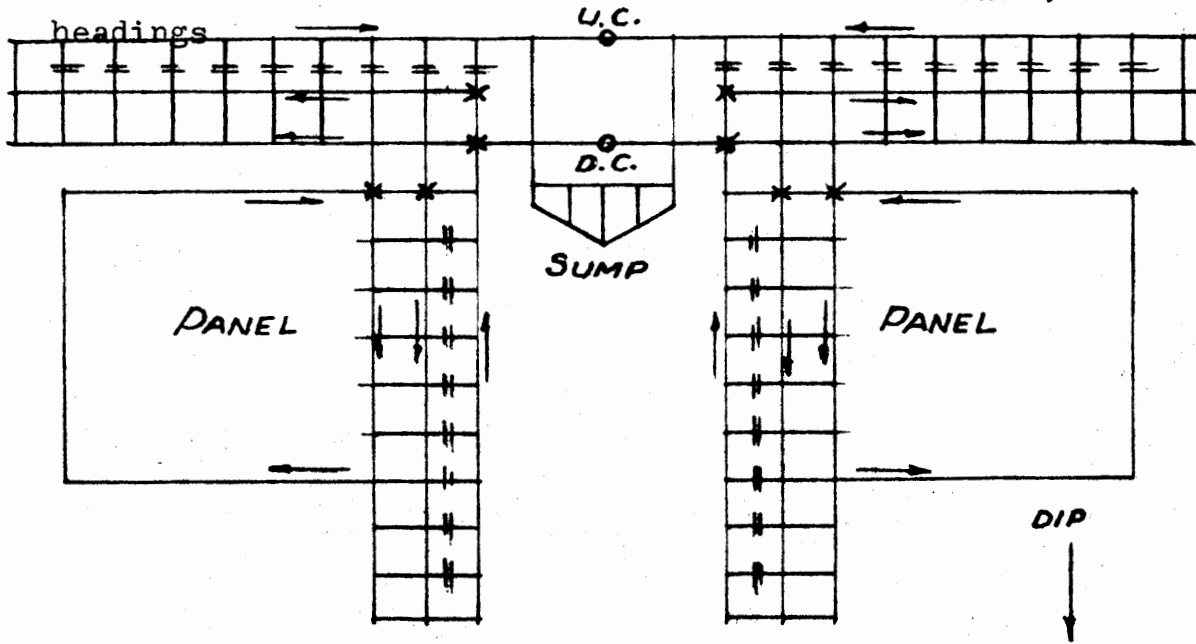

FIGURE 16

Mine workings with three main development headings

continuous miners provides a large and continuous production of coal. Mechanized development causes no bottleneck in getting a quick return of the money invested. A plan showing the layout of main and panel entries with continuous miners is shown in Figure 17.

Many combinations of machines may be used for development work depending upon the pitch of the seam and type of face machinery used. Development of headings by crawler mounted cutter and loader, electric drill and face chain conveyors is shown in Figure 18. This type of face machinery can be used in level, dip or rise headings with the pitch as high as 7° or 8° (1 in 8). In level or nearly level seams, development machinery may consist of mobile (tire mounted) cutter, loader, electric drills and shuttle cars. The shuttle cars load directly on to mine cars or belt conveyors. Development of a set of four main entries by continuous mining machine is shown in Figure 19. The solid line represents the coal face at the end of a complete cycle of operations and the broken line shows the advance of the coal face at the end of the next complete cycle of operation (1 thru 6). The continuous mining machine discharges coal onto the floor from where mobile loading machine transfers it onto shuttle cars. The coal is transported in the shuttle cars to the unloading station where it is dumped into an elevating conveyor which conveys the coal to a chain conveyor for deliverence into mine cars. Arrangements may also be made to load directly on to mine

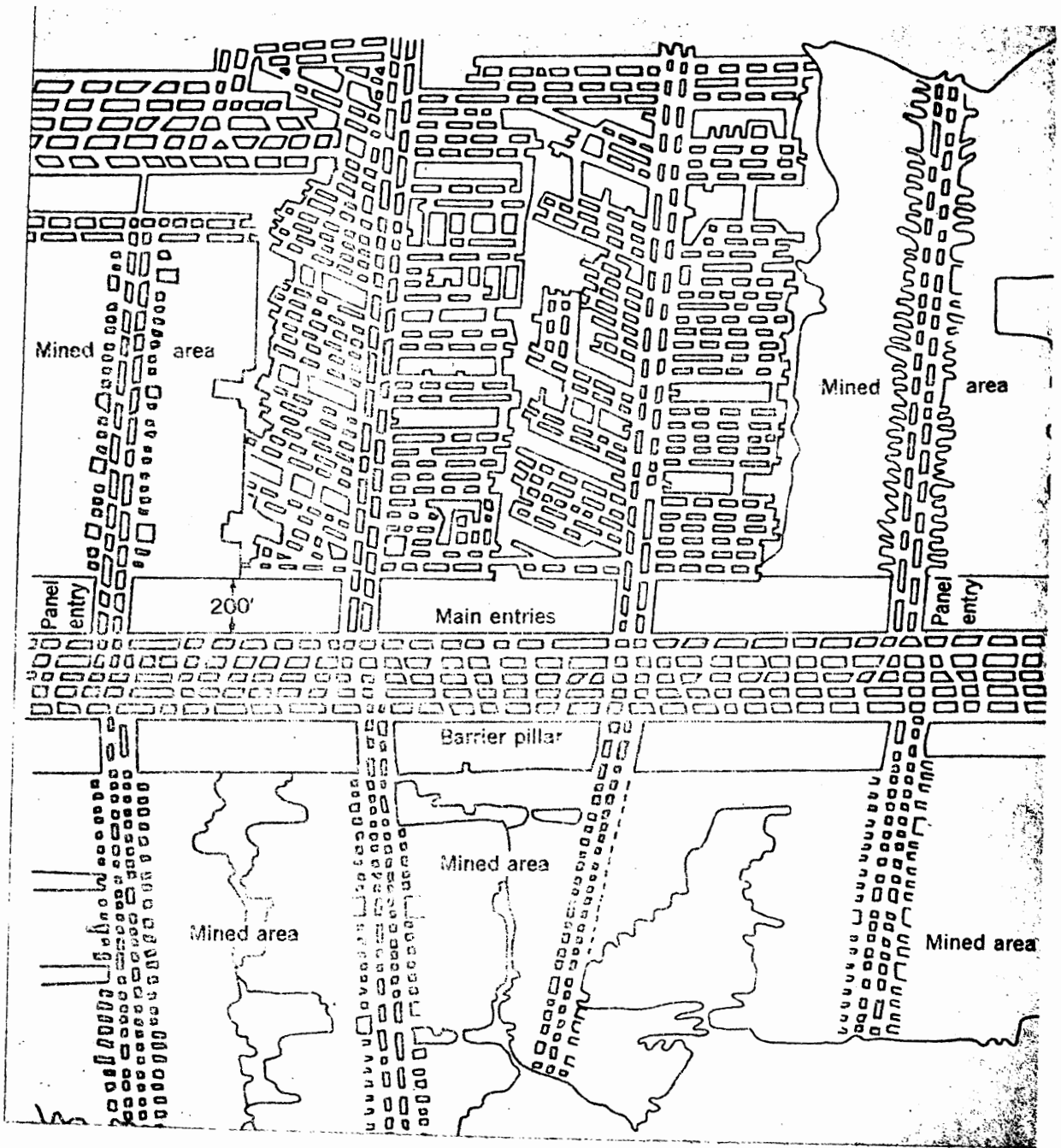

Figure 17

Mine plan showing layout of main and panel entries (38)

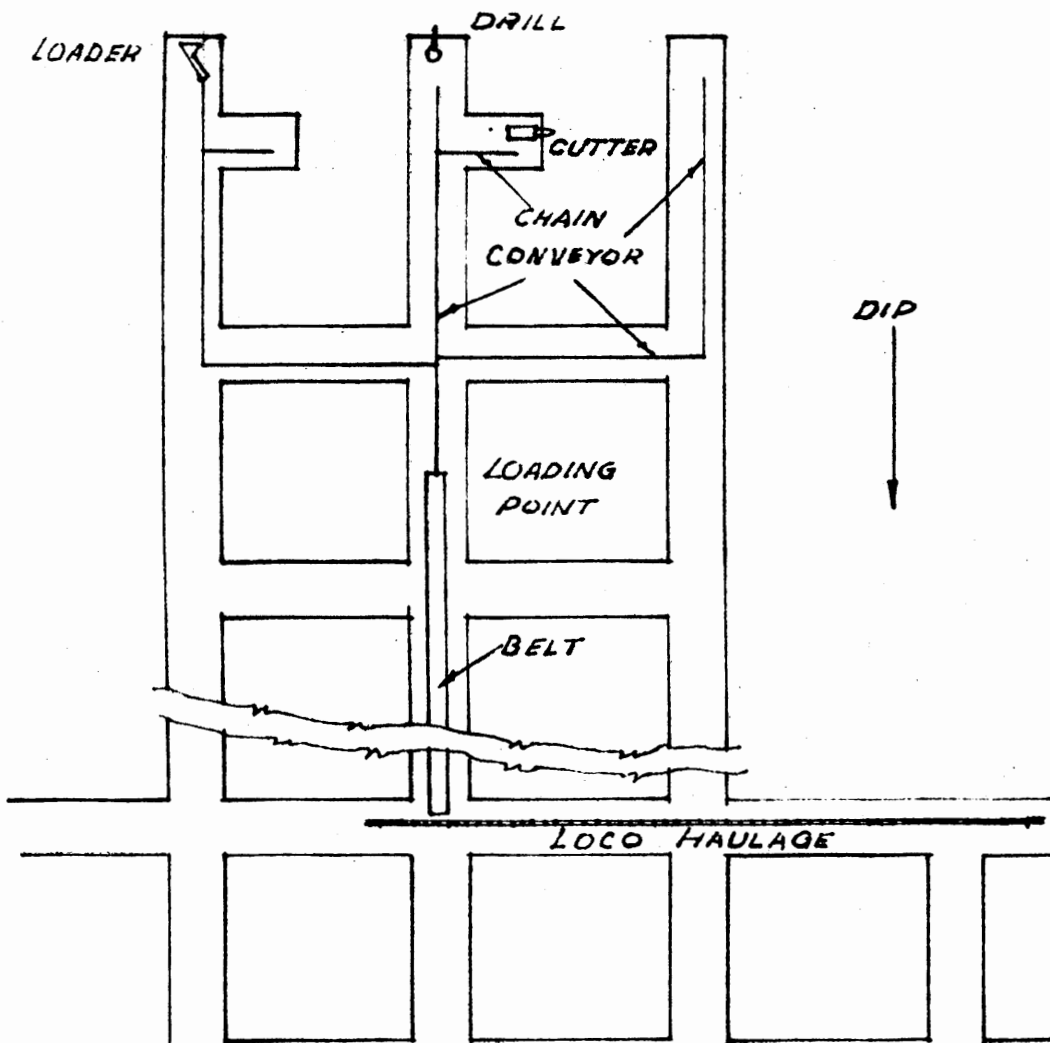

FIGURE 18

Plan of development headings using crawler mounted cutter and loader, electric drill and face conveyors

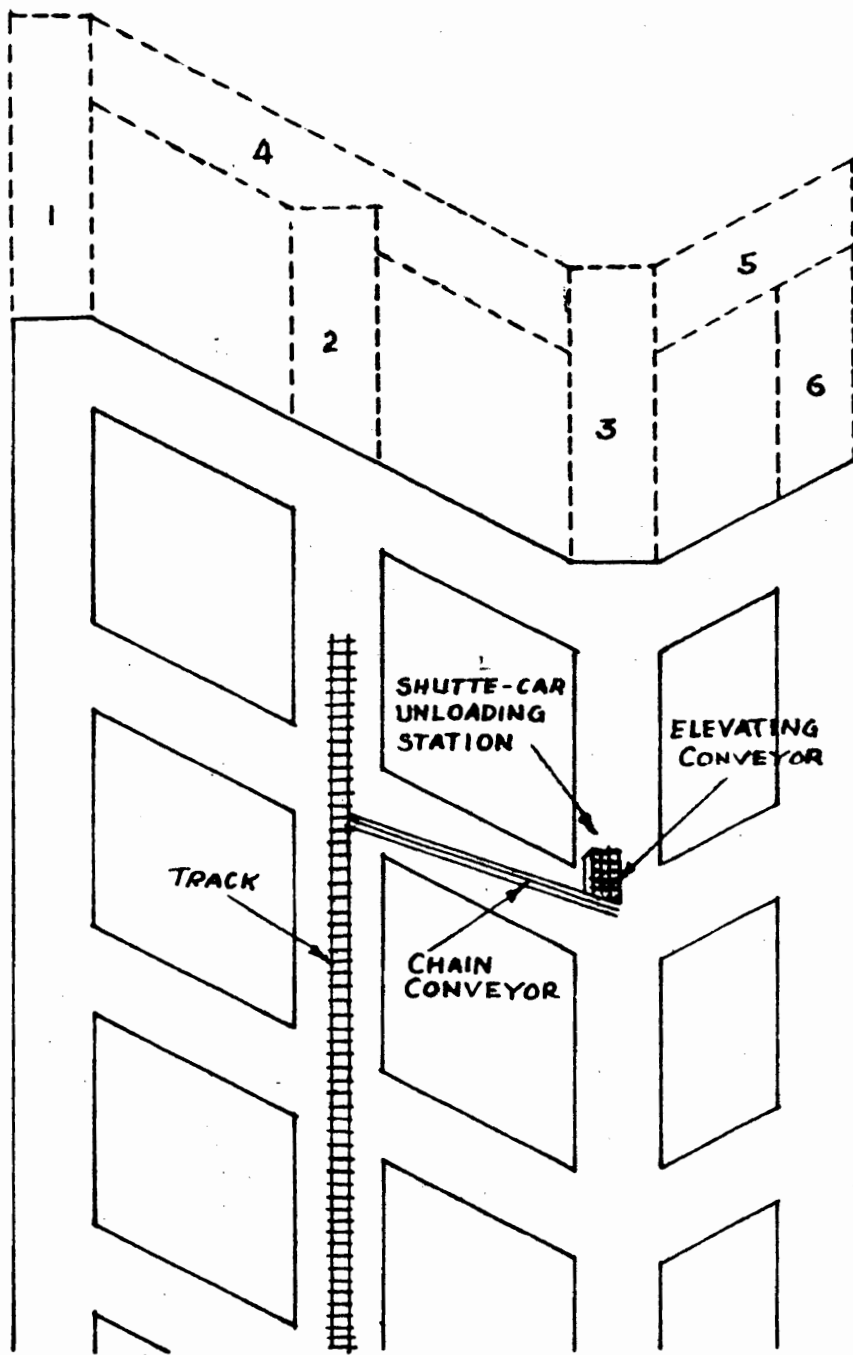

FIGURE 19

Development of main entries by Continuous Miner (21)

cars from the shuttle cars by preparing a suitable ramp at the loading point (21,33).

Development of a set of three panel entries by continuous miner is shown in Figure 20. The solid lines in entries 1, 2 and 3 represent the advance of the face at the end of a complete cycle of operation and the broken lines represent the advance of the face at the end of the succeeding cycle of operations (cuts 1 thru 6). The equipment consists of a continuous miner, two shuttle cars, one loader and a belt conveyor.

In single level mining operations, all development work is done in coal except in thin seams where additional headroom is required for the main haulage and traveling road. Such roads are heightened by brushing the roof or floor. In such cases, the roadways are driven wider in coal and the rock from the brushing is used as packing on the sides of such brushed roads.

Development work for the longwall advancing system in single level operations is quite simple and requires much less time to open full production faces. The main and panel entries for the longwall advancing system are shown in Figure 21. All machinery required for development will be the same as in the case of Room and Pillar mining. The choice depends upon the pitch and thickness of the seam. In the case of longwall retreating, gate roads from the panel entries may be driven in pairs to a certain fixed boundary and the face is then opened by connecting the

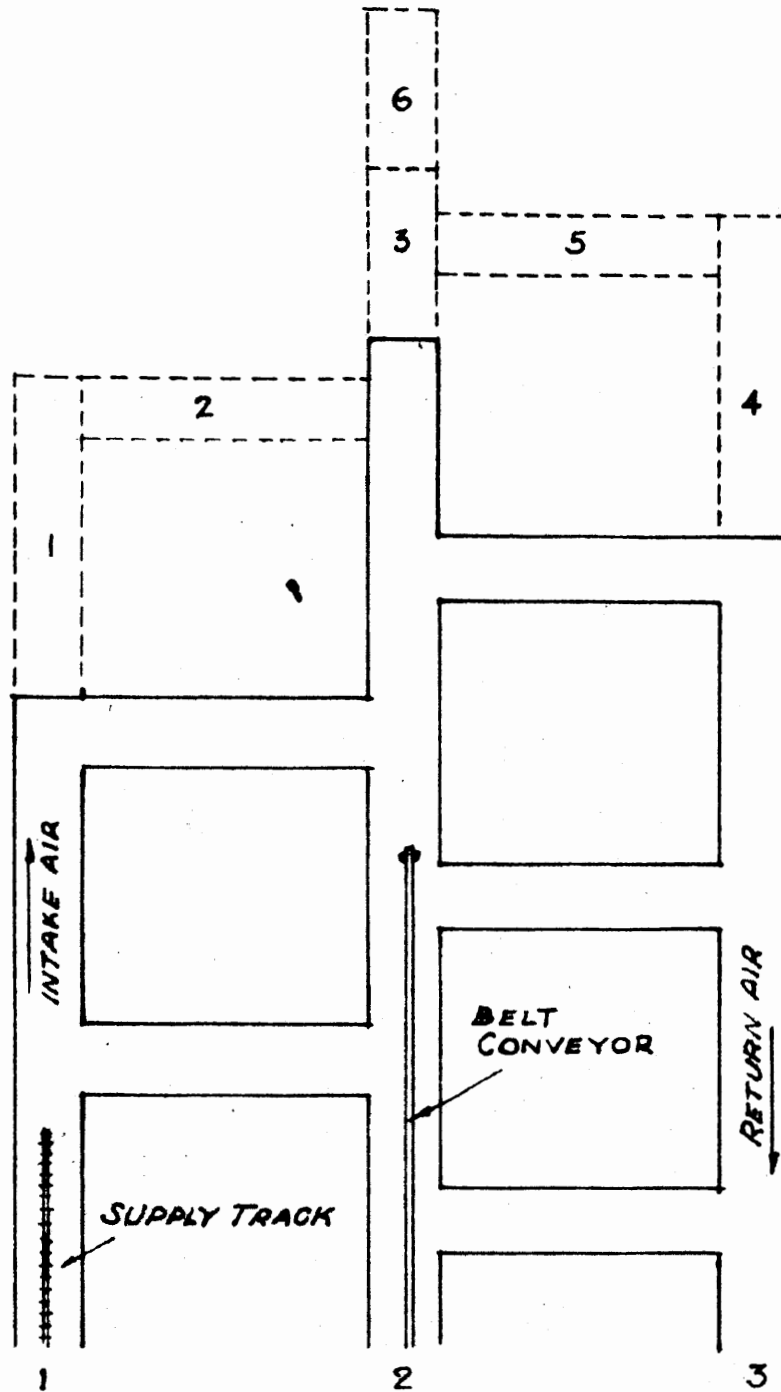

FIGURE 20

Development of panel entries by Continuous Miner (21)

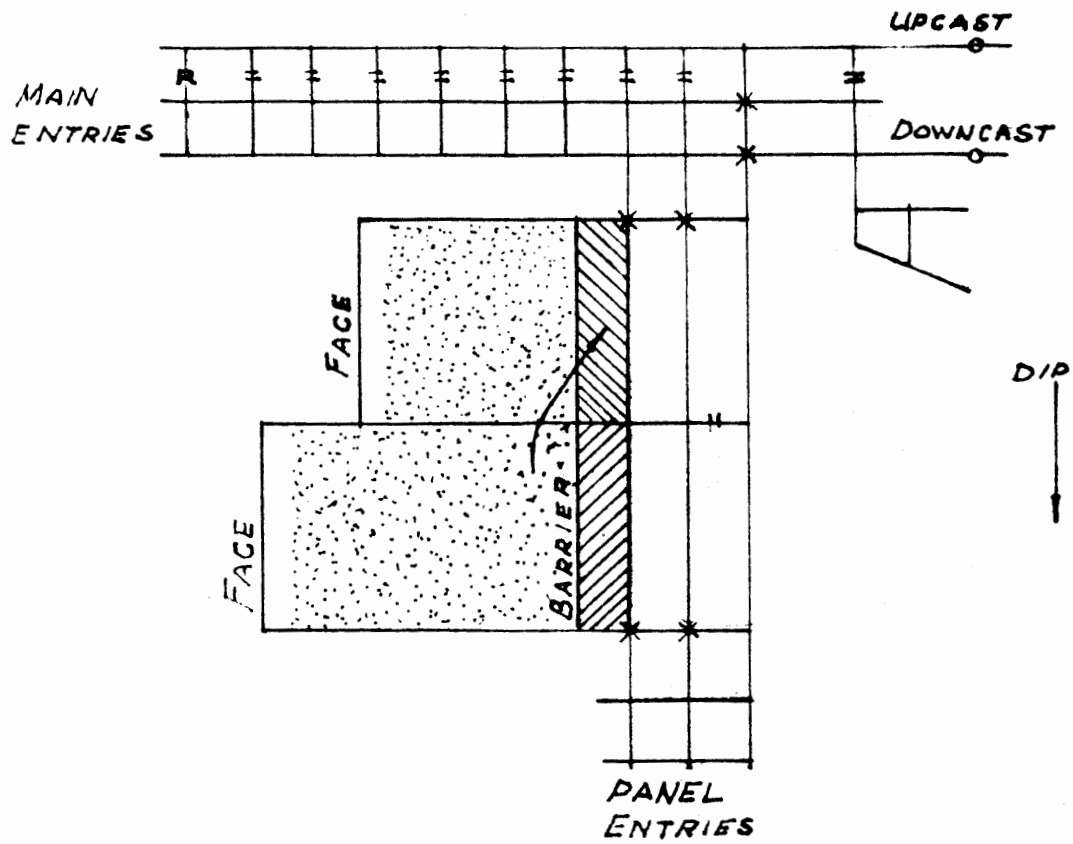

FIGURE 21

Main and panel entries in Advancing Longwall workings

upper and the lower gates. Development work in the long-wall retreating system is more costly as a longer time is required to open production faces.

Horizon Mining

In Horizon Mining the development work is extensive and complicated and practically all the work is done in rock until the production face is opened. Development work in rock is very costly and consequently very careful planning is essential for successful operation of the mine. In horizon mining, the shafts are sunk to a depth some distance below the seam to be worked and, from this point, level drifts are then driven through barren strata to meet the seam. At least two levels, at an appropriate distance apart, are required to win the coal between these levels. The upper level is always the main return airway whereas the lower level is the main intake and haulage roadway. Supply and stowing materials are normally brought to the face through the main return airway. Thus, to extract the coal from "A", Figure 22, No. 2 level is for haulage and air intake and No. 1 level is the return. Before all the coal is taken out from "A" another deeper level 3 is driven in advance so that extraction can be gradually switched to section "B" without loss of production. For a certain time, both Nos. 2 and 3 levels will work as haulage roads and No. 1 as ventilation roadway. When all the coal in the section "A" is extracted then No. 3 level will be the haulage and intake level and No. 2 will

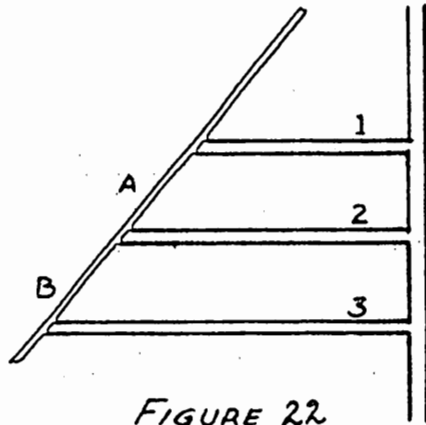
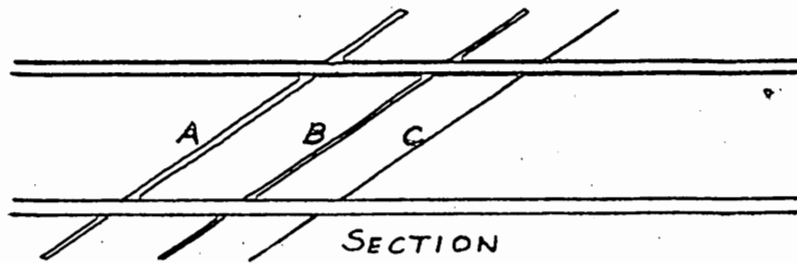
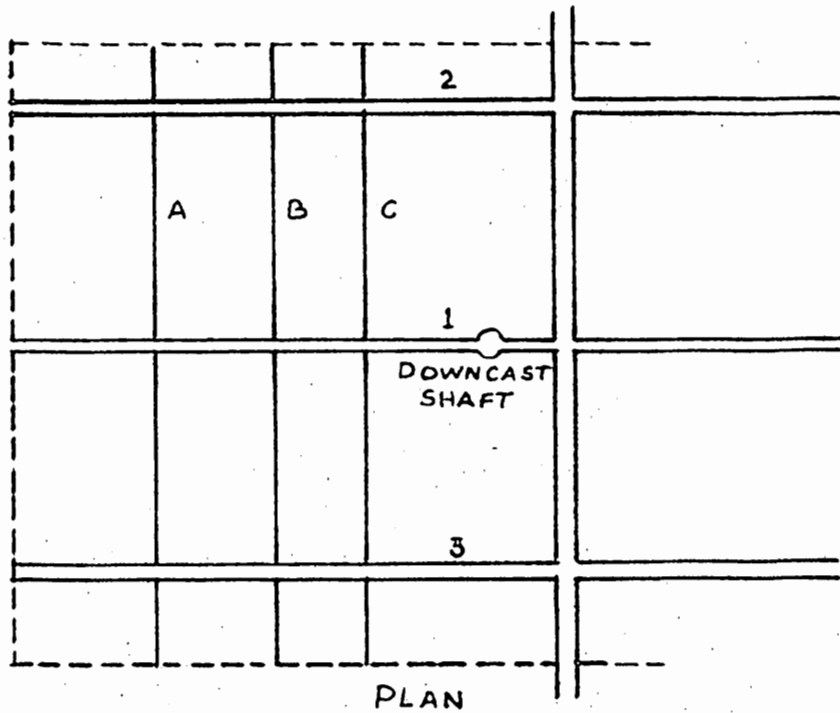

FIGURE 22

Working a seam by Horizon system



SECTION



PLAN

FIGURE 23 Plan and section

showing the network of roadways in any horizon

will be the ventilation level. The depth to which the shaft is to be sunk below the point where it intersects the seam depends upon the depth and pitch of the seam and the distance to the next adjacent seams. This determines the distance to be driven along the level to intersect the coal seam. Integral in the system is the use of staple pits to reach the seam at intermediate points. These staple pits serve as connections between horizons in order to facilitate ventilation and transport of coal, men and materials. These staple pits may be driven either immediately between the horizons or between the intervening seams and the upper or lower horizons. (11).

The main haulage horizon consists of a network of level roads which are used for transport, ventilation, access to the intermediate seams and providing points of attack for developing the reserves into suitable panels or units. These roadways are known as cross-cuts or cross measure drifts when driven at right angles to the strike, as lateral drifts or lateral roads when driven parallel to the strike and as gate roads, comprising mother gates, center gates and tail gates, when driven in the seam to handle the transport of coal, waste and supplies. A plan and section showing the network of level roadways in a typical horizon is shown in Figure 23. The cross-cuts are driven to intersect the seams and divide the reserves in that particular horizon into districts of suitable size. The cross-cut beginning at the shaft bottom, No. 1 in

Figure 23, is called main cross-cut. The others Nos. 2 and 3 are known as district cross-cuts. These district cross-cuts serve to distribute ventilation by splitting the air into several parallel circuits. The distance between these cross-cuts depends upon the maintenance cost of gate roads and cost of gate road conveying. Increased rate of advance of the gate roads due to better mechanization of the faces tends to increase the distance between the cross-cuts. The usual distance preferred in flat measures (-20°) is between 800 to 1200 yards.

The main lateral roads are driven along the strike and the cross-cuts intersect them at intervals. They are driven as straight as possible and their gradient is usually in favor of the loaded cars. The lateral roads may be in the seam or in the barren strata. Generally, they are driven in the rock and, in many cases, in the strongest measures in order to reduce the maintenance costs even if the hauling distance to the shaft is increased. The number of lateral roads required for one horizon depends upon the extent of the area to be worked, the number of seams to be worked and their geological grouping. Generally, one is sufficient but if groups of seams occur at certain distances apart, then two separate lateral roads may be required.

The layout of the main return airway horizon is based upon principles which are similar to those of the main haulage horizon. This is because the main haulage

horizon ultimately becomes the return airway when a new and lower main haulage horizon has been developed.

The distance between the two main horizons, i.e., the main haulage and main return airway must be carefully chosen because once they have been planned and driven they remain fixed for the duration of the mining activities. There is an optimum distance between horizons at which mining costs will be a minimum. These costs include the cost due to development of the roadway network and staple pits belonging to the new horizon, maintenance of all the roadways and staple pits, hoisting of coal and materials in the staple pits, hoisting in the main shafts and, also, the costs due to ventilation, pumping and the time for man riding. Considering all these items of cost, a compromise must be made in order to have the optimum interval between the horizons which provides the minimum costs. The lateral extent and the quantity of reserves at a colliery bear the greatest influence upon the distance between horizons. Should the coal reserves be high, the most favorable distance will be less than if the reserves are small. Thus, the seam density or the proportion of total thickness of coal to strata plays a major part in deciding on the most appropriate distance to be adopted.

The seam distribution within the coal measures also bears influence upon the distance between horizons. If the seam sequence is repeated regularly in depth, this factor has little importance but if the seams occur in groups,

irregularly in depth, it is desirable to locate the main haulage horizon at such a depth that it is possible to work the lowest seam of any group from that horizon as shown in Figure 24. If this is not done there will be increased hoisting and other costs due to increased interval between the upper group of seams and the next horizon.

The distance between the horizons is also influenced by the length of the face and the method of working. In flat measures, this factor has no bearing on the interval between horizons but in semi-steep (20° to 40°) and steep (40°) measures the length of face to be worked has a great influence. If a seam is pitching 30° , a face 200 yards long will have a vertical interval of 100 yards and the distance between the horizons can be made 100 yards or any multiple of it. If the interval is only 100 yards, no sub-levels which increase the cost of drivages in rock will be required. Similarly, in steep measures pitching at 45° , a length of coal face 200 yards will have a vertical interval of about 140 yards. Generally, main level development is considered too costly to repeat at short intervals. Thus, in semi-steep or steep measures, a horizon interval of twice to four times the vertical height of coal face has proved to be the most suitable distance.

In countries like Germany, Holland and Belgium where the Horizon system of mining is largely used, the distance between horizons in flat measures commonly varies between

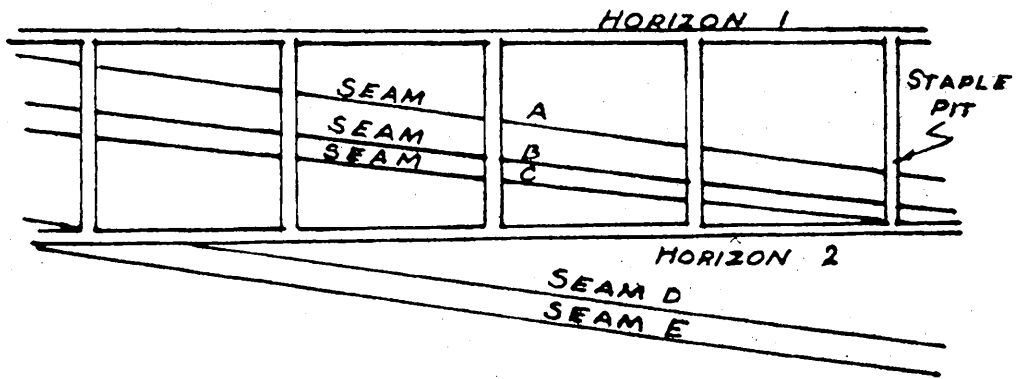

FIGURE 24

Location of main horizons in relation to seam sequence

(11)

100 and 200 yards. The seam density, or the proportion of total thickness of coal to strata, in these areas ranges between 0.9 and 4 percent. The horizon interval approaches the lower limit when the seam density is high, and the higher distance when it is low. The average life of the main haulage horizon varies between 10 and 25 years with an average yearly output of about 1 million tons. These periods are considered to be the most favorable for redemption of capital expenditure incurred in the development and maintenance of horizon. In semi-steep measures, the distances between horizons vary between 100 and 125 yards and in steep measures the intervals vary between 150 and 240 yards depending upon the influence of the coal reserves and the length of face to be employed. (11)

Locomotive haulage on the levels is universally adopted in this system of mining. This forms the cheapest and most flexible transport system.

A typical layout for a single seam horizon system is shown in Figure 25. Here the main intake haulage and main return airway cross-cuts are driven level from the respective shafts and touch the seam at E and F, and thus forming the limit along the dip of the first area ABCD of coal to be worked. The vertical interval between the two drifts in this case is 450 ft. and the full dip of the seam 1 in 4.5 or 12.7° . According to I.C.F. Statham (37, pg. 307);

*Roadways are driven in the seam to form return airways (giving ascensional ventilation), and to open out faces and conveyor roadways successively, ED, EC, GZ, and HZ, the

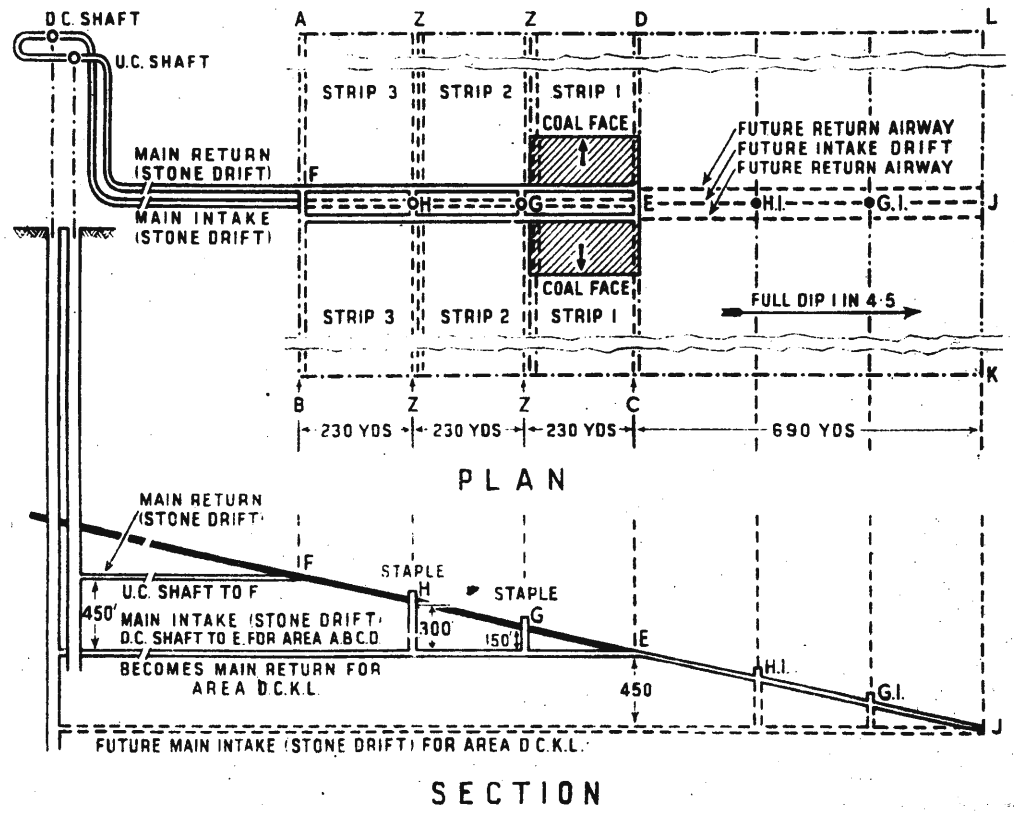

Figure 25

Typical layout for a single seam horizon system (37)

latter dividing the area into three strips, each 230 yards wide, on either side of the main intake roadway, suitable for longwall advancing single-unit working.

"Two 230-yd. wide faces (Strip 1) are worked simultaneously to predetermined distances ZD, ZC - which limit the extent of the first area to be worked - the coal being conveyed down the faces, along the bottom roadway, and loaded into tubs at point E.

"When Strip 1 has been exhausted, Strip 2 is worked in a similar manner, with the exception that the coal is delivered from the roadway conveyor onto a spiral conveyor (or chute) situated in the staple pit at point G, then loaded into tubs on the main intake drift. Strip 2 is replaced by Strip 3, the coal being loaded by way of the staple pit at point H, into tubs on the main intake roadway.

"If stowing material is required it is sent down the upcast shaft, hauled via the main return airway to point F, and then transported by conveyors along the return airway to the rise end of the faces.

"When the area ABCD is exhausted, another main intake airway drift is set out from the downcast shaft at a lower level to intercept the seam at point J, in order to work out the area DCKL, the intake roadway for the area ABCD becoming the return airway for the working area DCKL, and so on, progressively.

"Man-riding facilities are provided from the shafts to the inbye ends of either the main intake or main return roadway, points E and F, according to local circumstances."

CHAPTER V

EXTRACTION METHODS

Room and Pillar Workings

It was common practice in the past to drive headings and form pillars throughout the coal property before commencing pillar extraction. More recently, however, it has been recognized that by working coal in the panel system and leaving barriers on all sides, not only is the cost of heading decreased to a great extent but also crushing and over-riding of pillars can be avoided or reduced.

At the present day, most of the mines are worked by the panel system. It has the advantage of; (a) splitting the ventilating air current for each district and thus providing cleaner air in all areas, (b) comparatively better ventilation is obtained at later stages as the worked out districts can be effectively sealed off and thereby eliminating potential causes of contamination and spontaneous heating, (c) explosion in one district does not affect other districts, (d) as the panels of extraction are small in area, less time is allowed for the roof weight to act upon the pillars before they are extracted and, therefore, less danger to life and less wastage of coal due to crushing, (e) there is less danger of creep and fall of roof in rooms and (f) a large output can be obtained in a short time with comparatively less cost (37).

The area of a panel depends upon whether the seam is liable to spontaneous heating and, also, upon the speed of

extraction and depth. If the seams are liable to spontaneous heating, the area will depend on the incubation period and the speed of extraction. The incubation period is the time interval which extends from the time of starting pillar extraction to the time when the actual fire due to oxidation of crushed coal appears. As can be appreciated, it varies from seam to seam. The area in a panel depends also upon the speed of extraction which, in turn, depends upon the type of machinery used; this fixes the maximum time available for pillar extraction to fall within the incubation period. In some of the seams of India, the incubation period varies between 4 and 12 months. The panel area, in such seams is normally about 600 ft. by 600 ft. in plan. It is desirable, from the roof control point of view, to allow subsidence to reach the surface quite readily but, in deep mines, with relatively small size panels and with solid barrier pillars surrounding it, subsidence may not reach the surface within the practical mining period. As a result, adjacent areas will take on added loads. In order to prevent this in deeper mines, a larger panel is used and the entire area is developed before extraction of pillars is attempted. During the final phase, artificial panels are formed by stoppings which enclose a small number of pillars. These panels are then extracted during the very latest mining stages which may extend into the incubation period.

Figures 26, 27, 28 and 29 show, in line diagram, the layout of panels in a Room and Pillar system and the various

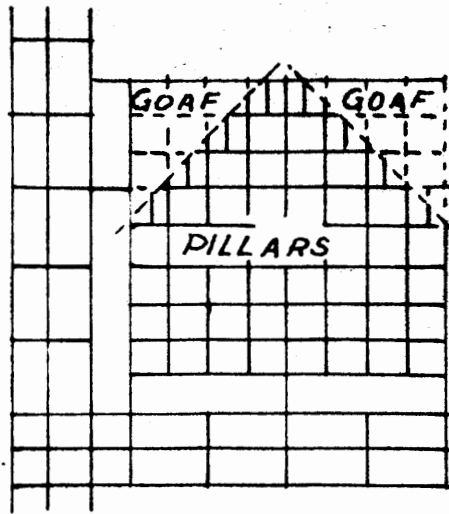

MAIN ROADS

FIGURE 26

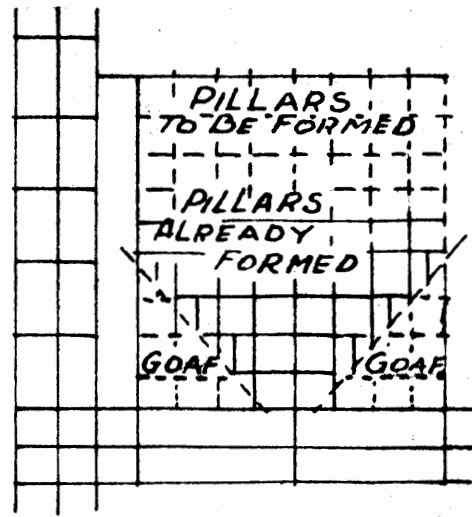

MAIN ROADS

FIGURE 27

Layout of panels in Room and Pillar workings showing different methods of pillar extraction

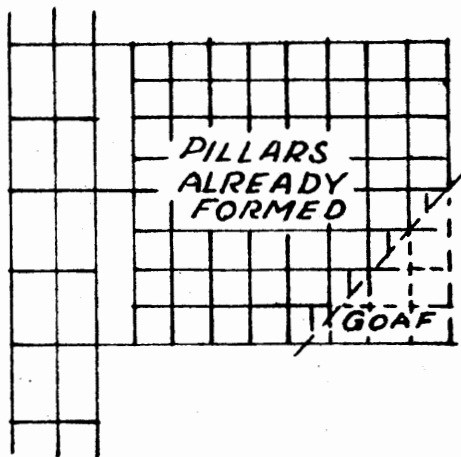

MAIN ROADS

FIGURE 28

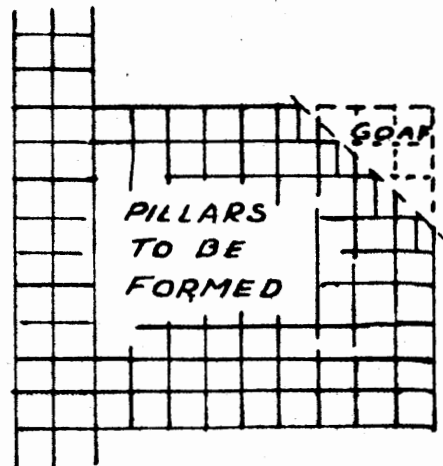

MAIN ROADS

FIGURE 29

methods of pillar extraction. Figure 26 shows how the panel was first fully developed and then retreated with complete extraction. In Figure 27 the "whole working" or development is followed by the "broken working" or pillar extraction. The full lines show pillars already formed and the dotted lines indicate pillars that are yet to be formed. In this method, the pillars are extracted as soon as they are formed so that they will not be subjected to crushing through excessive life. In both these cases, the pillars are shown to be extracted from two sides of the panel. Here, the fracture or goaf lines form a "V" and roof control difficulties are likely to occur where these lines intersect. If this system of extraction cannot be avoided, it is desirable that the apex angle made by the two fracture lines should be as wide as possible in order to avoid a concentration of roof pressures on the adjoining pillars at the apex. The best method will be to have a single fracture line across the whole panel which will reduce the likelihood of roof trouble. This is shown in Figure 28. The ideal condition, from the roof control point of view, will be to have a "broken" working followed closely behind the "whole" working with a single fracture line as shown in Figure 29.

Under normal conditions, the fracture line is kept diagonal and along the cleat. This is shown by the sequence of extraction in Figure 30 where each pillar is split into 4 blocks or stooks. In such cases, maximum support, in the area under extraction, is provided because each pillar is

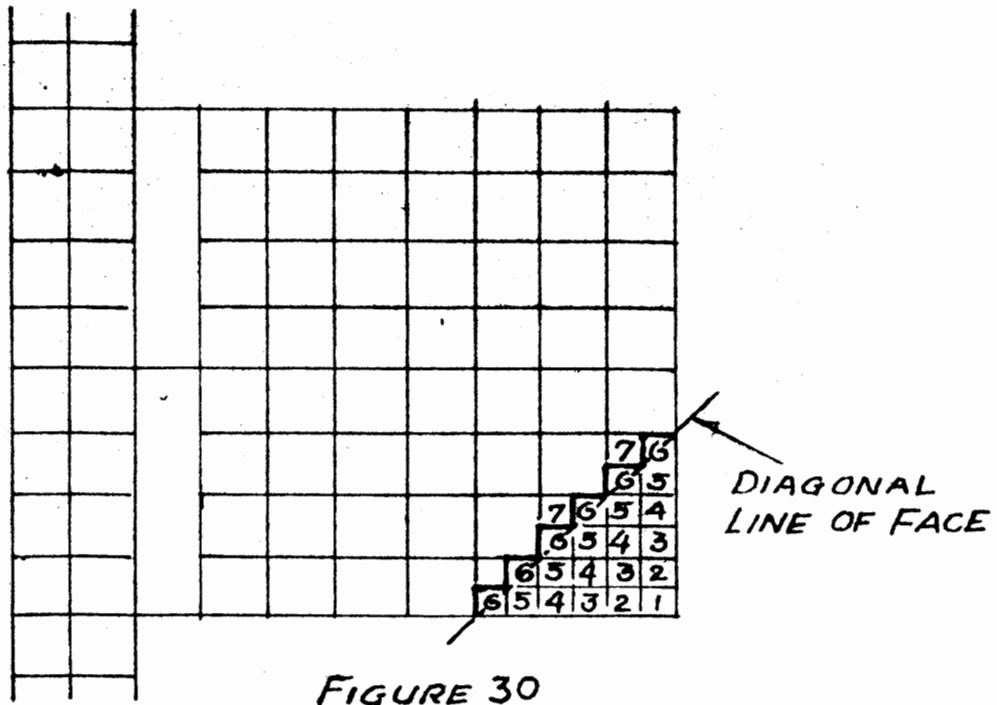

FIGURE 30

Extraction of pillars on diagonal line of face

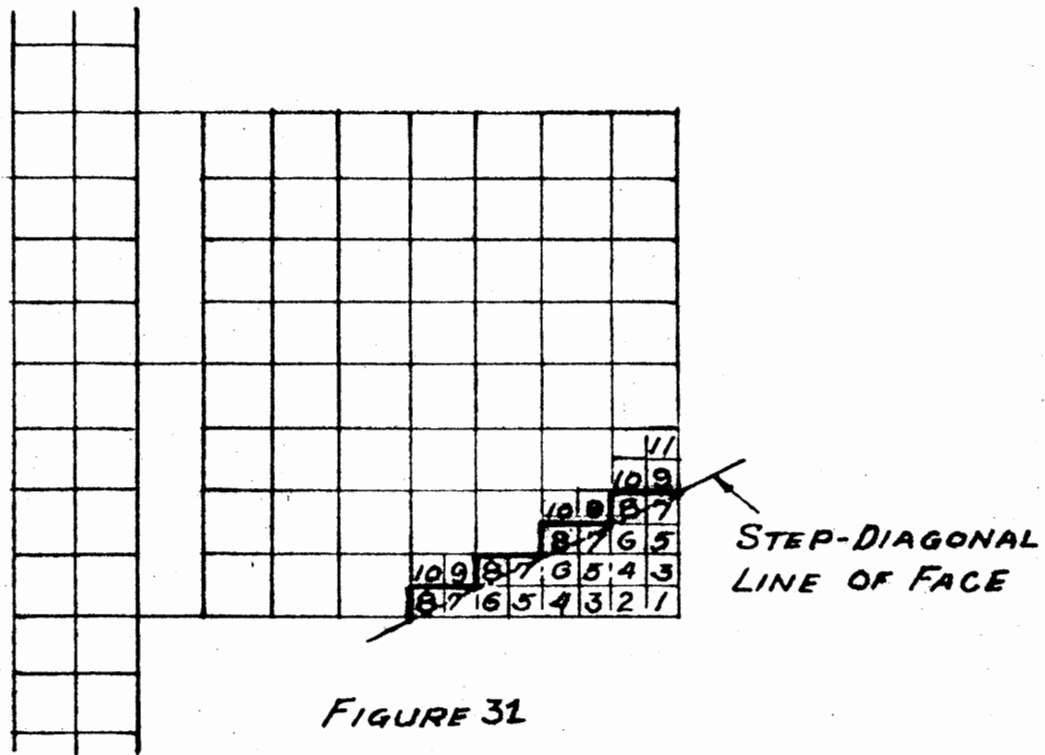

FIGURE 31

Extraction of pillars on step-diagonal line of face

contributing half the pillar support. The portion of the goaf protruding into the pillars or the area unsupported is at a minimum when the angle is 45 degrees. If the line of break is at right angles to the cleat, the roof will remain suspended for a long time and may cause excessive loading on adjacent pillars. The line of fracture can be changed, the amount depending upon roof conditions, to induce earlier or delayed break of the roof. Thus, the step-diagonal line of fracture is shown by the sequence of extraction in Figure 31. The correct line of fracture or the correct line of face has to be determined by actual experience with the particular seam under extraction. In deep mines, especially, the cleats must be observed carefully. The direction of splits which divide the pillars into smaller blocks at the time of extraction depends upon local conditions. Sometimes the splits may collapse if the area is heavily stressed and where the split is parallel to the direction of cleat. In faulted areas, usually the line of fracture should not be made parallel to the fault plane. The face in such cases should be maintained at some angle to the fault plane.

The success of pillar extraction lies in allowing the roof to break regularly along the line of face and, also, in regulating the speed at which the fracture traverses across a pillar, panel or series of panels in order to effectively relieve the strata pressure on adjoining coal pillars. The faster the speed of fracture travel, the more effectively is the strata pressure diverted into the goaf.

The method of extracting panels in a mine varies widely and depends upon many factors such as depth, thickness of seam, nature of roof and floor, pitch of the seam and, also, upon the type of machinery used and the prevalent mining practices in similar coal fields.

Planning for the purpose of exploitation in room and pillar system can be arranged in two different ways, e.g., (a) layouts in which the formation of pillars is the first aim, and, as such pillars contain the majority of coal, they are extracted subsequently; and (b) layouts in which rooms are formed separated by thin pillars or ribs. The majority of coal is extracted from the rooms and the ribs or the thin pillars are not extracted or partially recovered.

In category (a), about 15 to 35 percent of the seam is extracted in the first mining operations and, in category (b), the percentage so extracted is much higher.

Thin Seams

Seams less than 3 ft. in thickness are not generally suitable for the room and pillar method of working. Seams less than 4 ft. in thickness give rise to trouble with the disposal of dirt which is produced by brushing of roof or floor. It is desirable, in such workings, to keep at a minimum the number of roadways required for haulage and ventilation, because of the high cost of making such roads. Moreover, the efficiency of men and machines is impaired at the face with low headroom. However, at the present day,

machines have been designed to work thin seams efficiently in such workings.

Figure 32 shows the layout of room and pillar mining in a thin (26 inch), nearly flat seam. Piggyback units consisting of Pigloader, Piggyback conveyor, chain conveyor with crawler mounted drive, coal cutter and hand held electric drill are used for the room work. After the three panel headings are driven to a predetermined limit, a pair of rooms is turned 90 degrees off each side of the entry. A Piggyback unit advances each pair of rooms to a predetermined boundary. The rooms are wide and the narrow pillars between are not recovered. The room chain conveyors are set 2 ft. off centers to provide a roadway in the center of the rooms for the Pigloader which shuttles back and forth between the two rooms. All other equipment remains in each individual room. Roof bolts are installed on 4-foot centers throughout the rooms. (13).

Another method of extraction in a seam 30 inches thick at a depth ranging from 600 ft. to 1200 ft., is shown in Figure 33. Mining is done by coal cutter with hand loading onto a room conveyor. The rooms are turned 90 degrees off the entry and driven to a predetermined boundary. The necks of the rooms are narrow for some distance and then the width is gradually increased to the full room width. No cross-cuts are made between rooms and the resulting solid pillar is extracted from the inbye end by the "open-end" method. Extraction begins when the room has reached its full length.

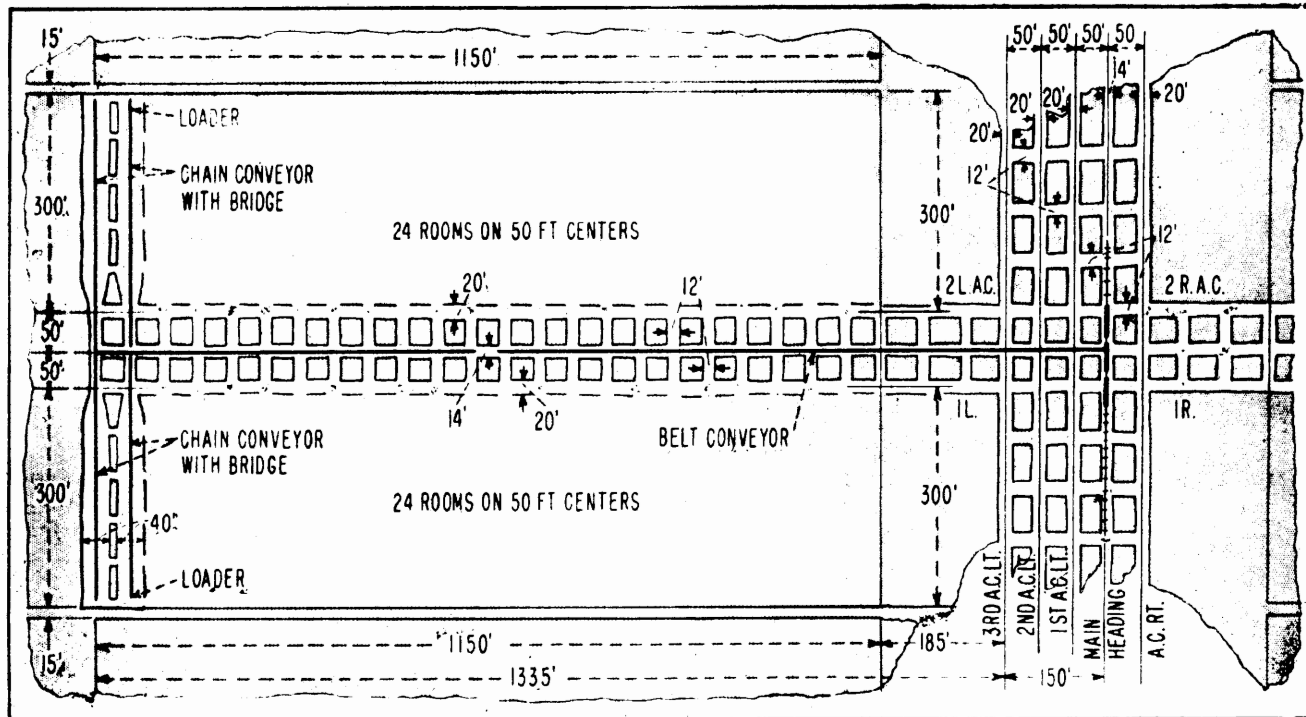

MINING PLAN for room panel using bridge units includes driving pairs of rooms off both sides on retreat.

Figure 32

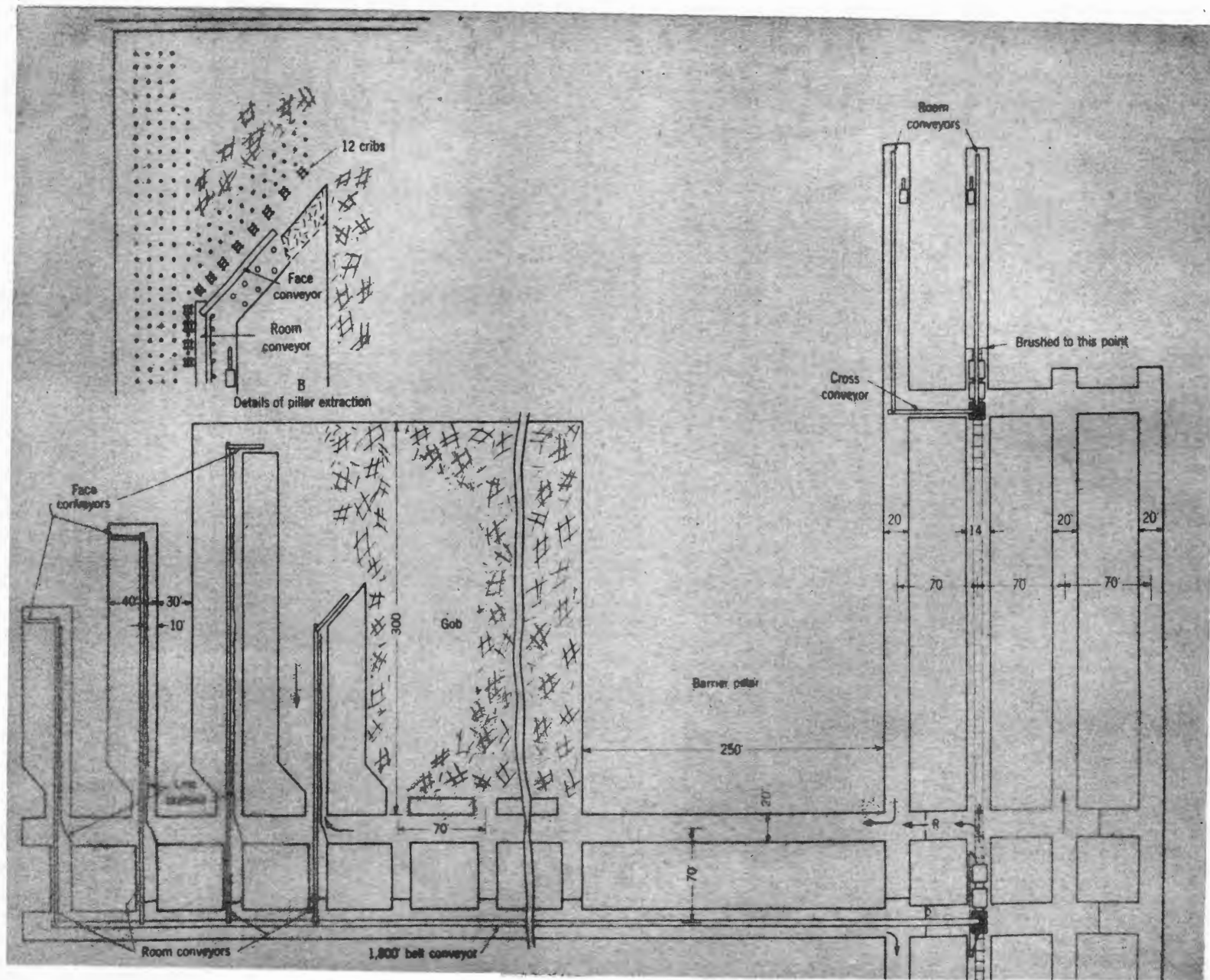

Figure 33

Plan of extraction in a thin seam (39)

In extracting the pillar between rooms, a cross-cut is made in the pillar at the inbye end of the room. The end of the pillar is then cut and extraction proceeds by making repeated cuts on this open end. The cuts are so made that the face of the pillar is at an angle of 45-degrees to the room line. The room is supported on the advance by using props on 4 ft. centers. During pillar extraction, the face is protected by wooden cribs or chocks which are advanced as the face of the pillar retreats. The coal is hand loaded on the face conveyor.

The equipment that is used in room and pillar workings in thin seams includes scrapers, chain and shaking conveyors which are loaded by hand, duckbills which load onto shaking conveyors, low capacity mobile equipment for loading shaking conveyors or shuttle cars and many types of auxiliary equipment that are used with these units. A new auger type continuous miner has been developed in 1956 to mine such thin seams (44). Figure 34 shows the layout of rooms in a nearly flat thin seam where each room is provided with one continuous miner of the auger type. Coal is conveyed through the machine by a chain conveyor and transferred to a chain-flight bridge conveyor which is integral with the unit. From here, the coal passes over an extensible room belt conveyor and is fed onto the main belt through a cross belt. The main belt conveyor is extended every two pillars. Figure 35 shows a roof support plan wherein both roof bolts and timber props are used so as to

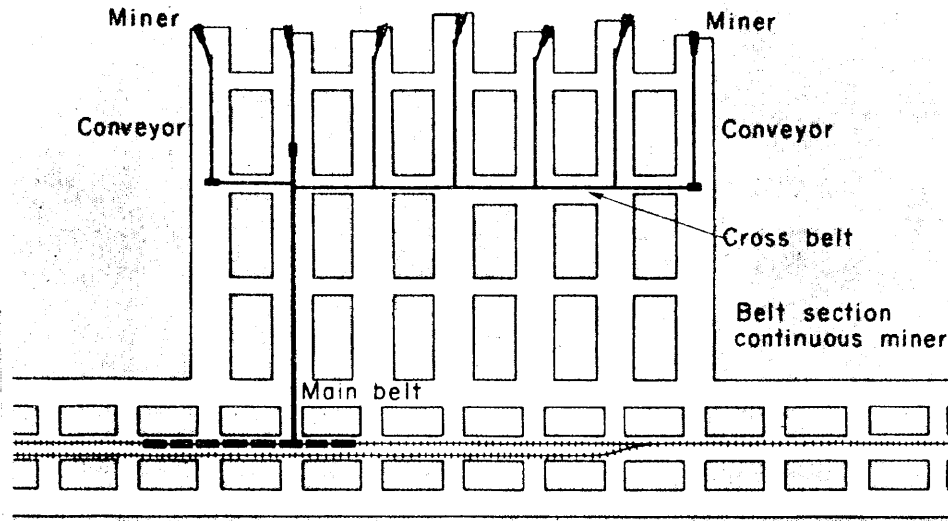

Figure 34

Plan of Room and Pillar workings in thin seam with Continuous Miner (44)

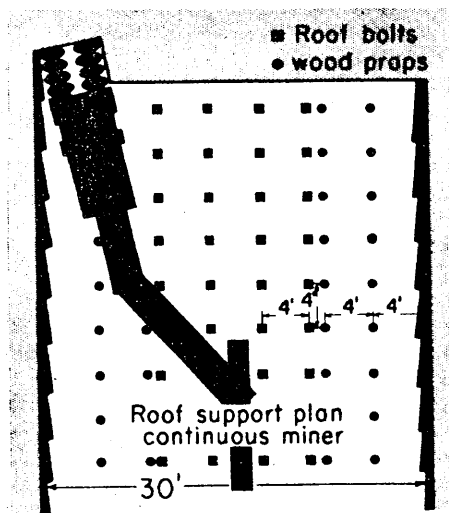

Figure 35

Roof support plan for Continuous Miner workings (44)

permit easy maneuvering of the miner. It provides maximum protection for the workmen with a minimum of timber removing and resetting. Figure 36 shows the development of rooms and extraction of pillars on the retreat by the same miner.

Moderately Thick Seams

Seams ranging from 3 ft. to 10 ft. in thickness are placed in this category. Figure 37 shows the layout and method of extraction of a 5 foot thick, flat seam in which rooms are turned at an angle of 60° from the entry and driven to a predetermined boundary. The rooms are made wide with thin non-recoverable pillars between. Room necks are driven narrow for about 20 ft. and then gradually widened to the full room width. Rooms are developed in blocks of twelve using the advance in one entry and the retreat system in the other. The coal is cut by a track mounted cutter, drilled and blasted and loaded onto mine cars by a mobile loader of the track mounted type. The rooms are timbered systematically as shown in the figure.

Figure 38 shows the layout and method of working in a flat seam which is 3 ft. 6 in. thick. In this case, the rooms are turned at right angles off both entry headings and driven to a predetermined boundary. The rooms are wide with breakthroughs at appropriate intervals. One cut which is approximately 6 ft. deep is taken off one side of each room pillar when it can be removed safely with the loading machine. Each room is equipped with a shortwall coal cutter.

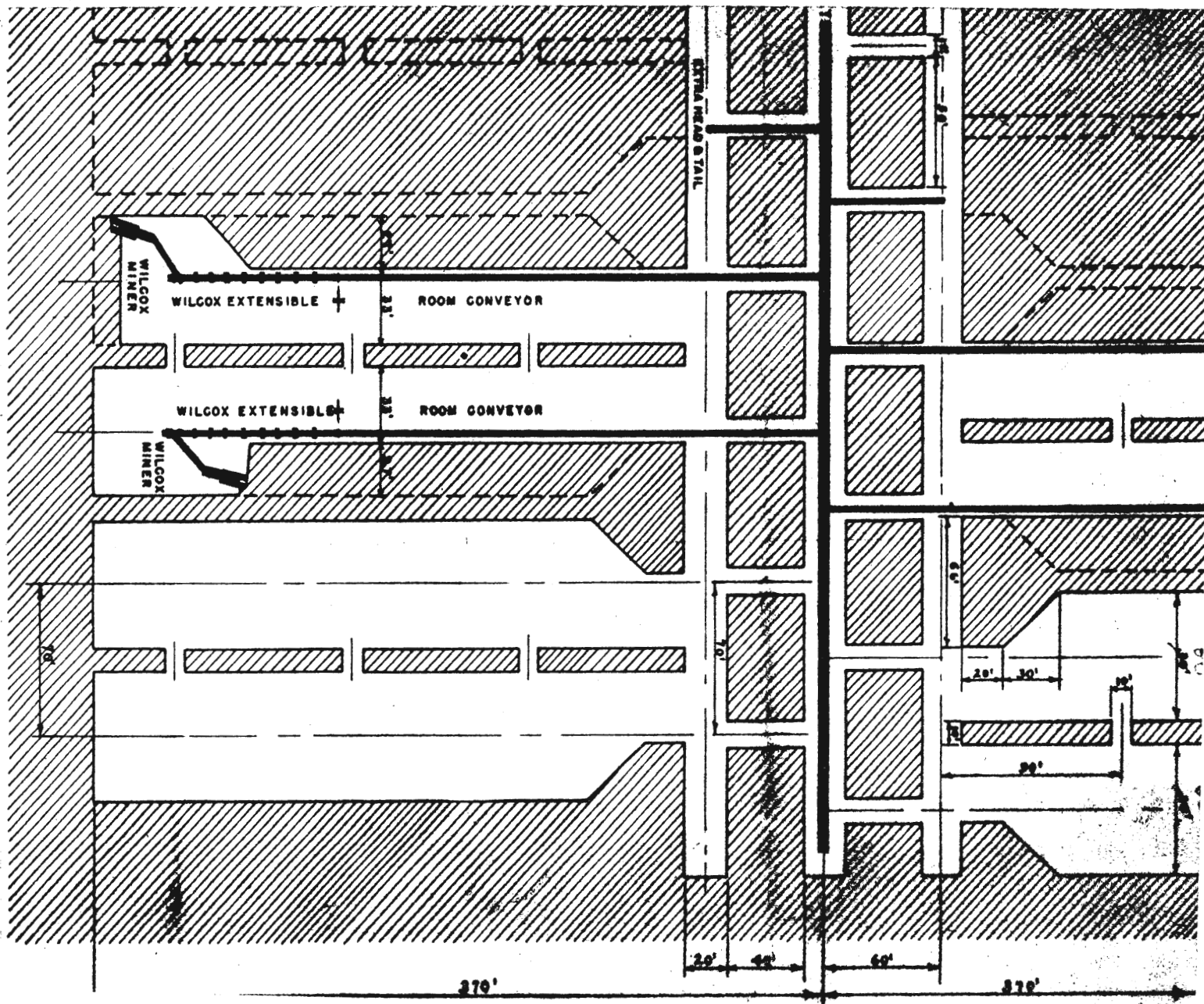

Figure 36

Detailed plan of rooms using Continuous Miner (44)

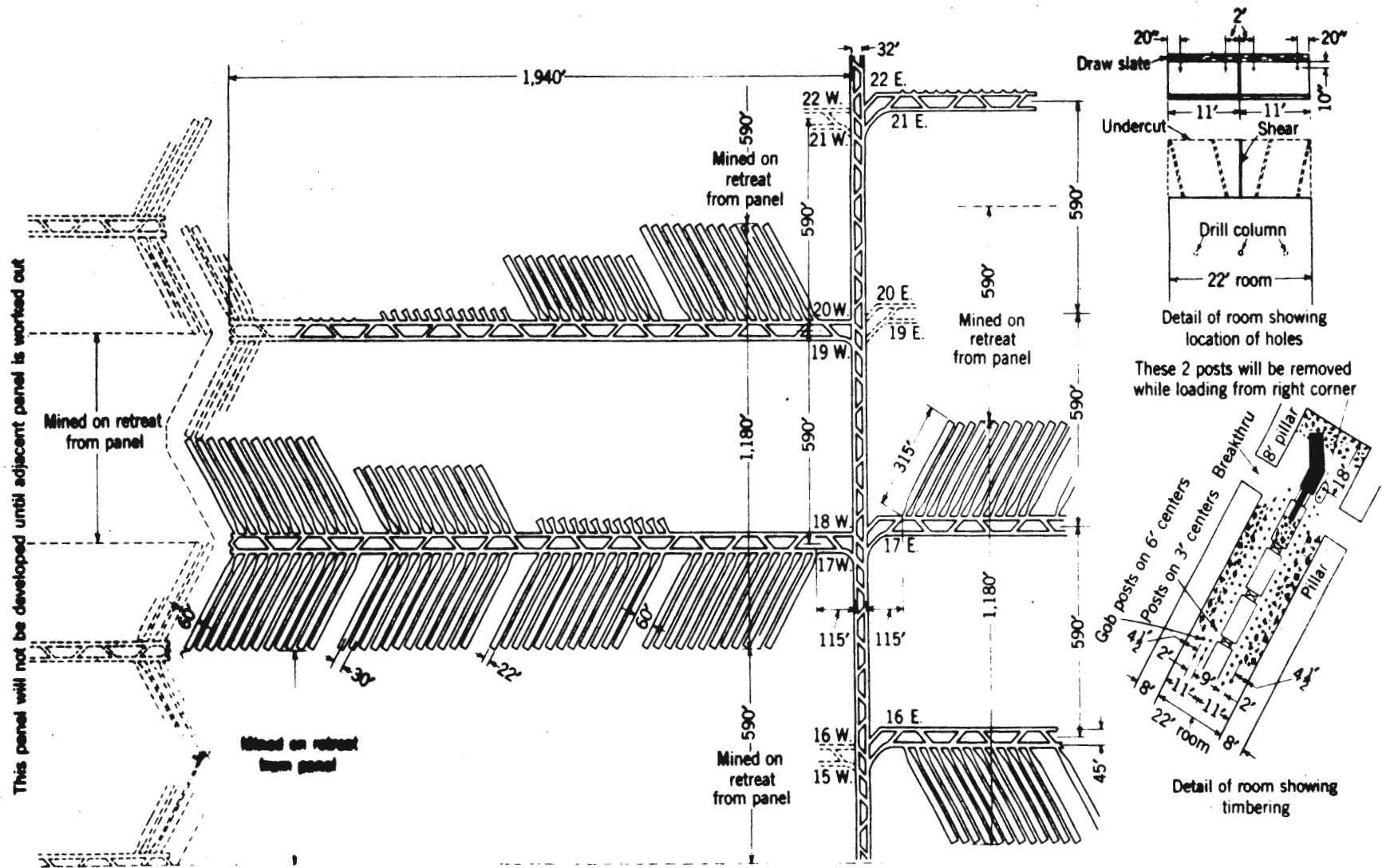

Figure 37

Plan of Room and Pillar workings having rooms 22 feet wide and 315 feet long (40)

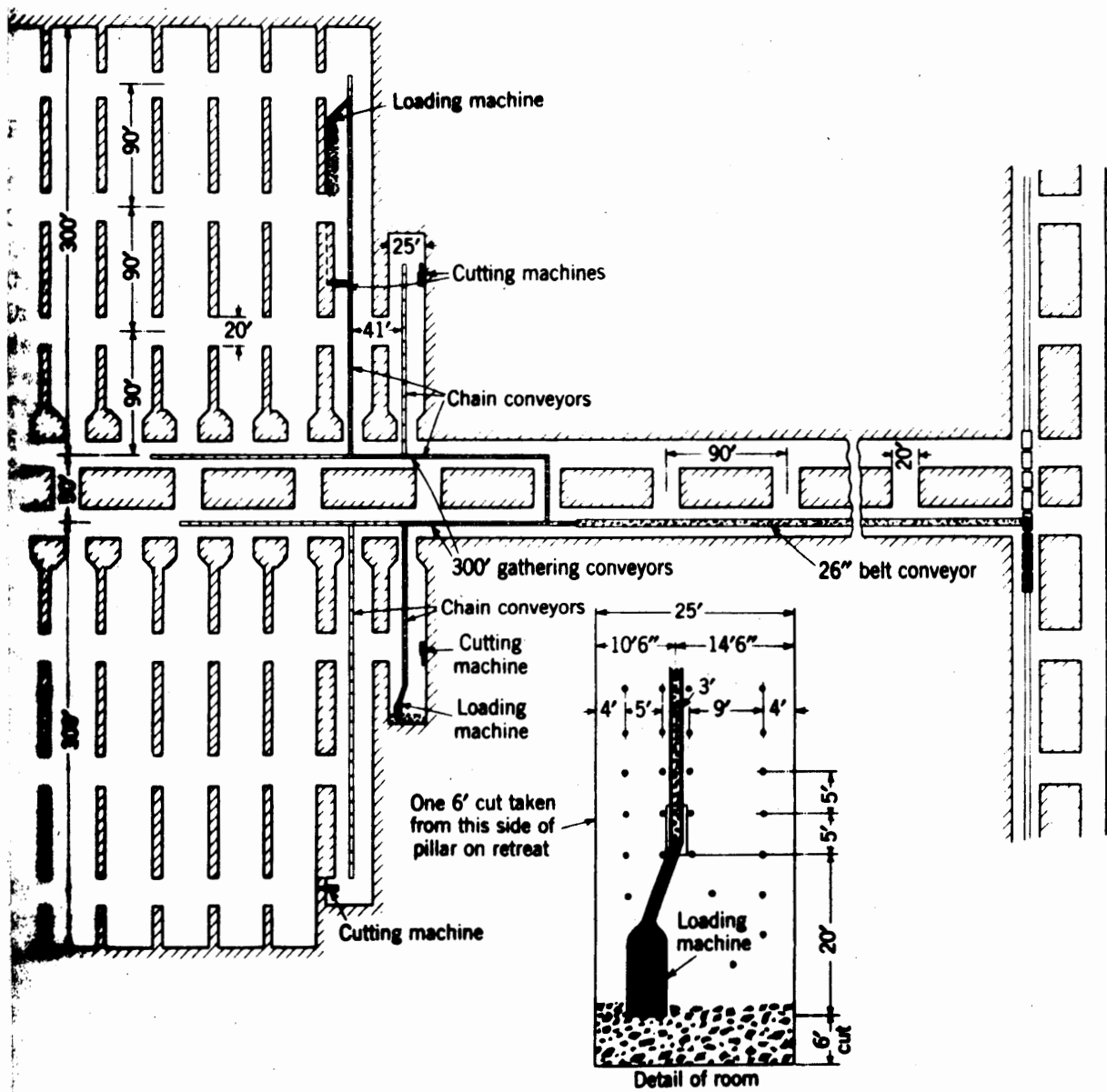

Figure 38
 Plan of Room and Pillar Workings (40)

After each cut, the face is drilled and blasted and a crawler mounted loading machine moves the coal onto a room chain conveyor.

Figure 39 shows the layout and method of extraction of a nearly flat seam which is 5 ft. 4 in. thick and at an average depth of 450 ft. The pillars formed in each panel are mined on the retreat while maintaining a diagonal line of fracture. They are taken by the "pocket and wing" method whereby each is split through the center and a pocket is then driven in the inbye portion at right angles to the split. A thin rib or wing is left between the pocket and gob. This wing is recovered after the pocket has been completed. A pocket may be driven along both inbye sides of the pillar thus leaving a rib or fender, about 5 or 6 ft. thick, between the pocket and the gob. The fender is then recovered by mining from the inbye end. The coal is cut by track mounted arc-wall machine, drilled by electric drills and blasted. It is loaded by mobile loading machines onto mine cars which are hauled by gathering locomotives. All places are timbered with three-piece sets on 4-foot centers and additional cross-bars and posts are set at the face as required.

Figures 40 and 41 show a panel layout and retreat method of pillar extraction. Cuts in the pillars are scheduled to maintain a uniform pillar line of 45-degrees to the direction of retreat. A typical schedule is given in Figure 41. The coal in each pillar is recovered in six lifts.

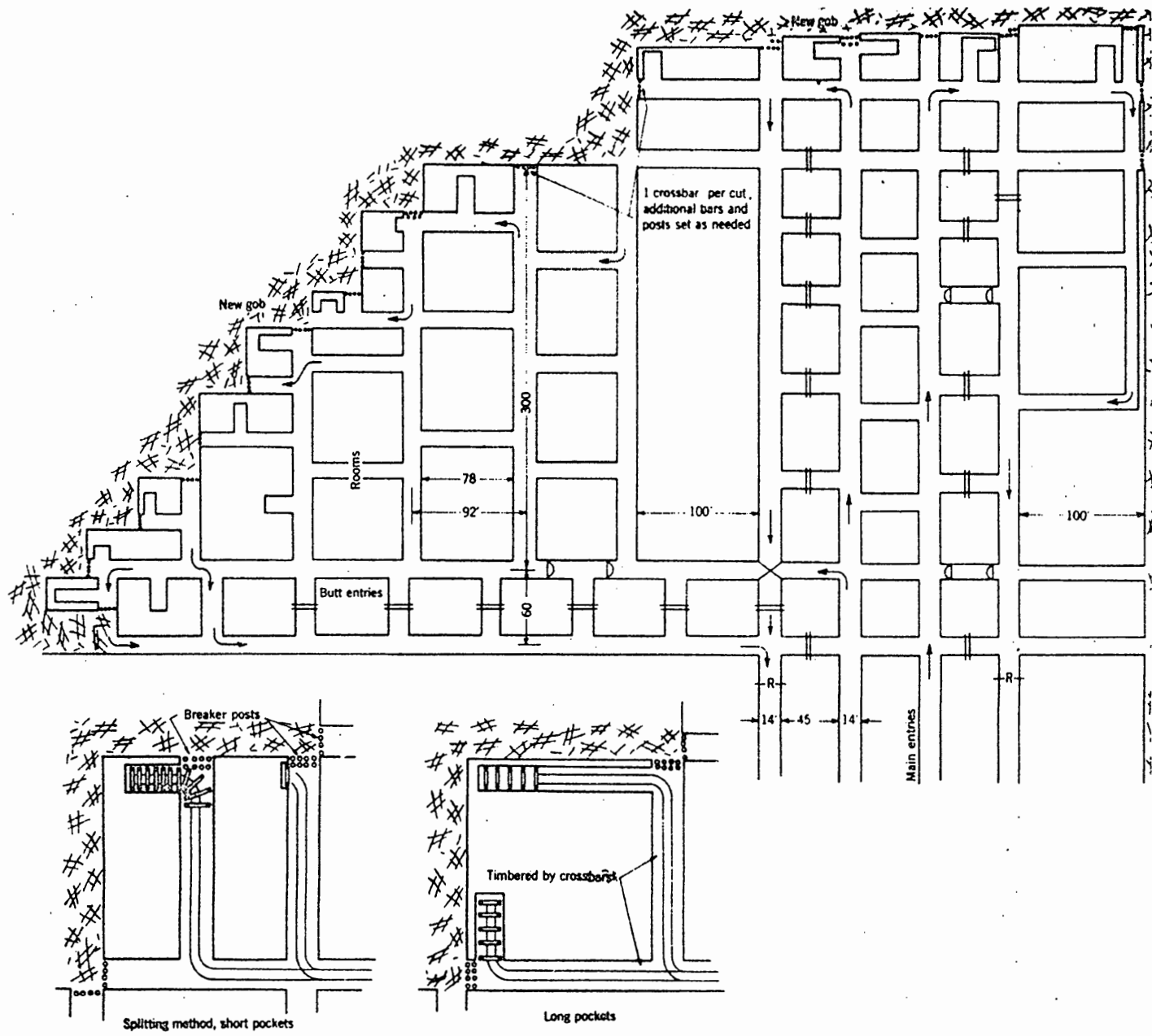

Figure 39
 Extraction of pillars on diagonal line in Room and Pillar workings (41)

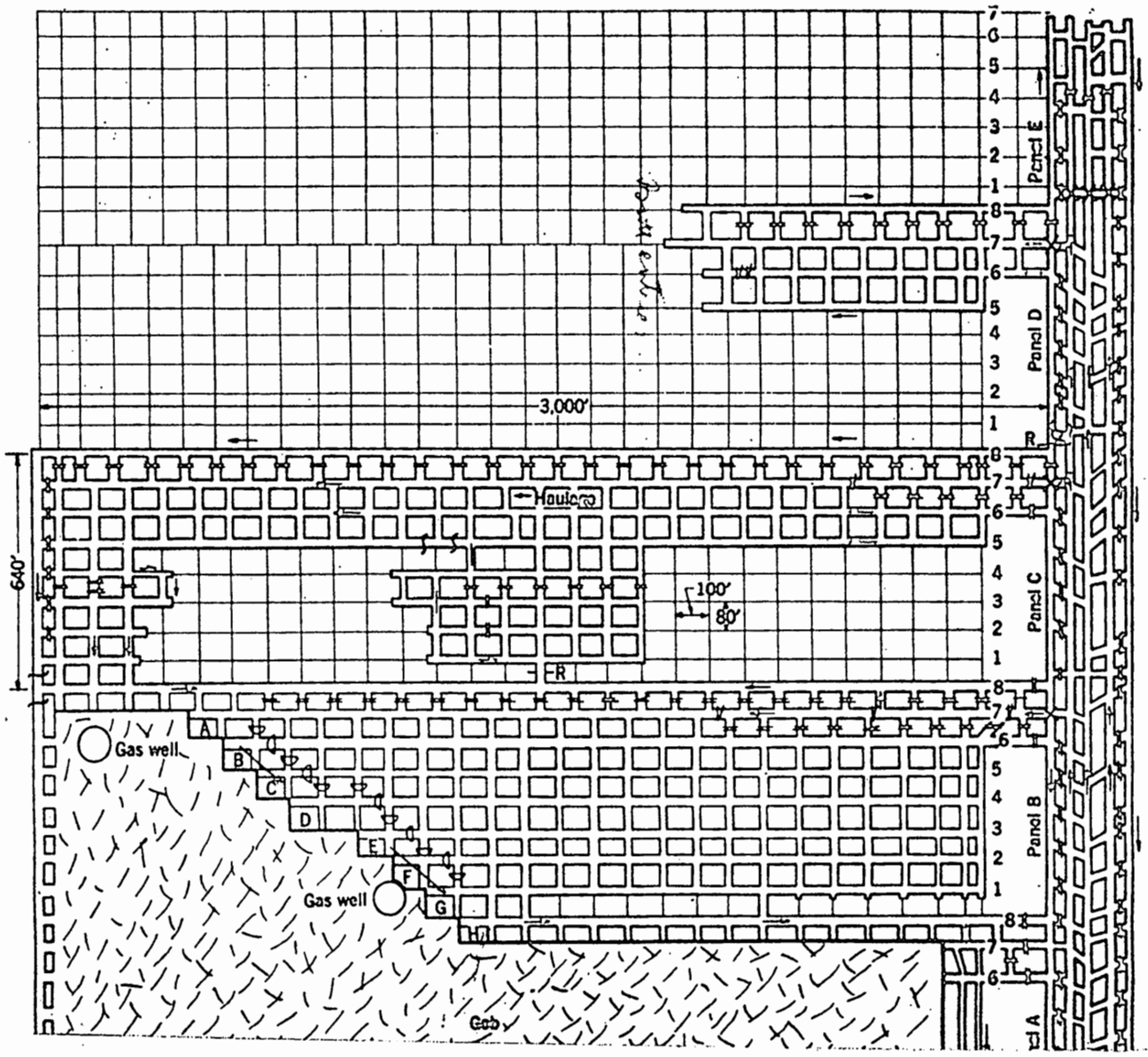

Figure 40

Layout of panels in Room and Pillar workings (43)

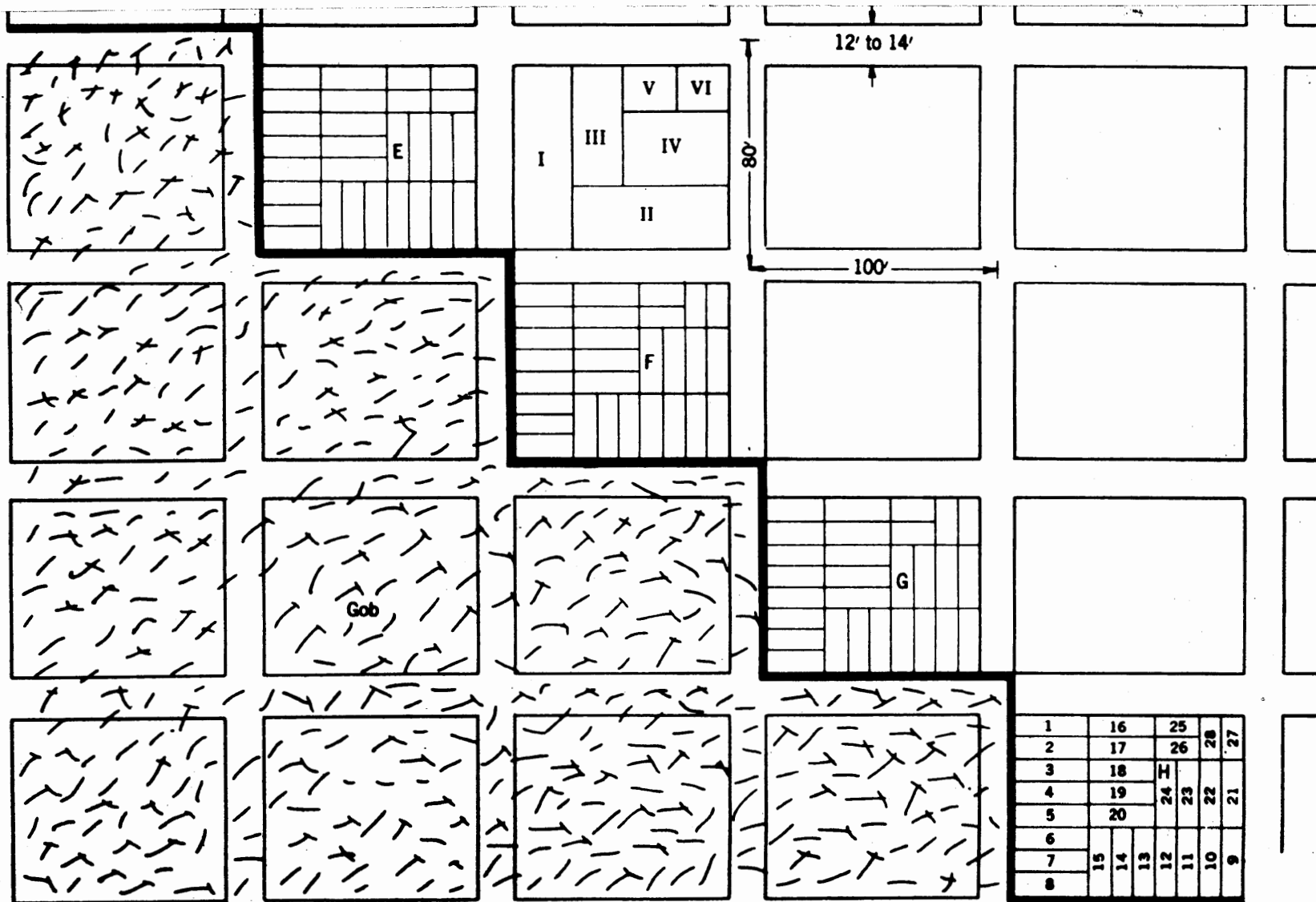

Figure 41
 Sequence of extraction of pillars in Room and Pillar workings (43)

Alternate lifts are made on the two gob sides of the pillar. This first lift is taken across the width of the pillar parallel to the main cleat of the roof rock which breaks readily. Thus the weight of the roof is prevented from carrying over to the unmined coal in the pillar. Cross-bars are set on $4\frac{1}{2}$ -foot centers in the working places, and props with cap pieces are placed along the gob side of the lift as needed. Upon the completion of the lift, the cross-bars and some of the props are pulled. Cutters, crawler mounted loaders and electric drills are used for the extraction of pillars. The loaders load the coal onto shuttle cars or directly onto mine cars.

Figure 42 shows a layout and method of extraction in a nearly flat seam, 8 ft. 6 in. thick, by a conventional system of room and pillar mining with mobile coal cutters, loaders, drills and shuttle cars. Pillars are extracted on the retreat when the development of the panel is complete. A pillar line is established about 30-degrees to the panel rooms. Development in the panels is timed so that mining of pillars in an inbye panel is started when the pillar line of the preceding panel reaches the last entry of the outbye panel. Thus, a continuous pillar line is maintained across two or more panels. The method of pillar extraction and the sequence of cuts in each pillar are shown in the figure. The first operation in extracting a pillar is to drive a split through the pillar, parallel to the panel entry. This split is not "holed through" until the inbye pillar has been

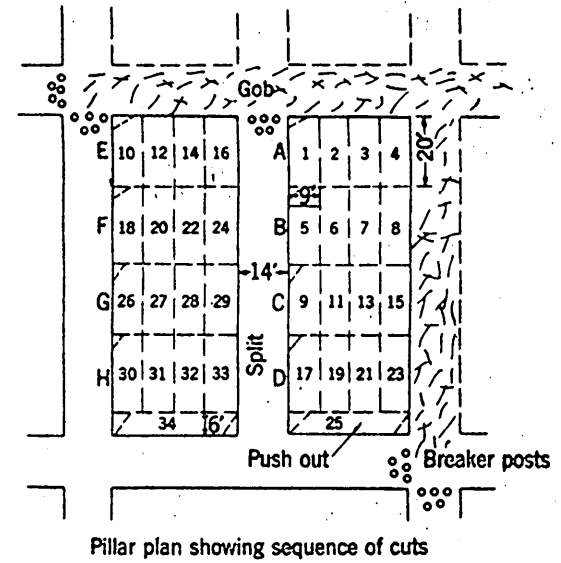
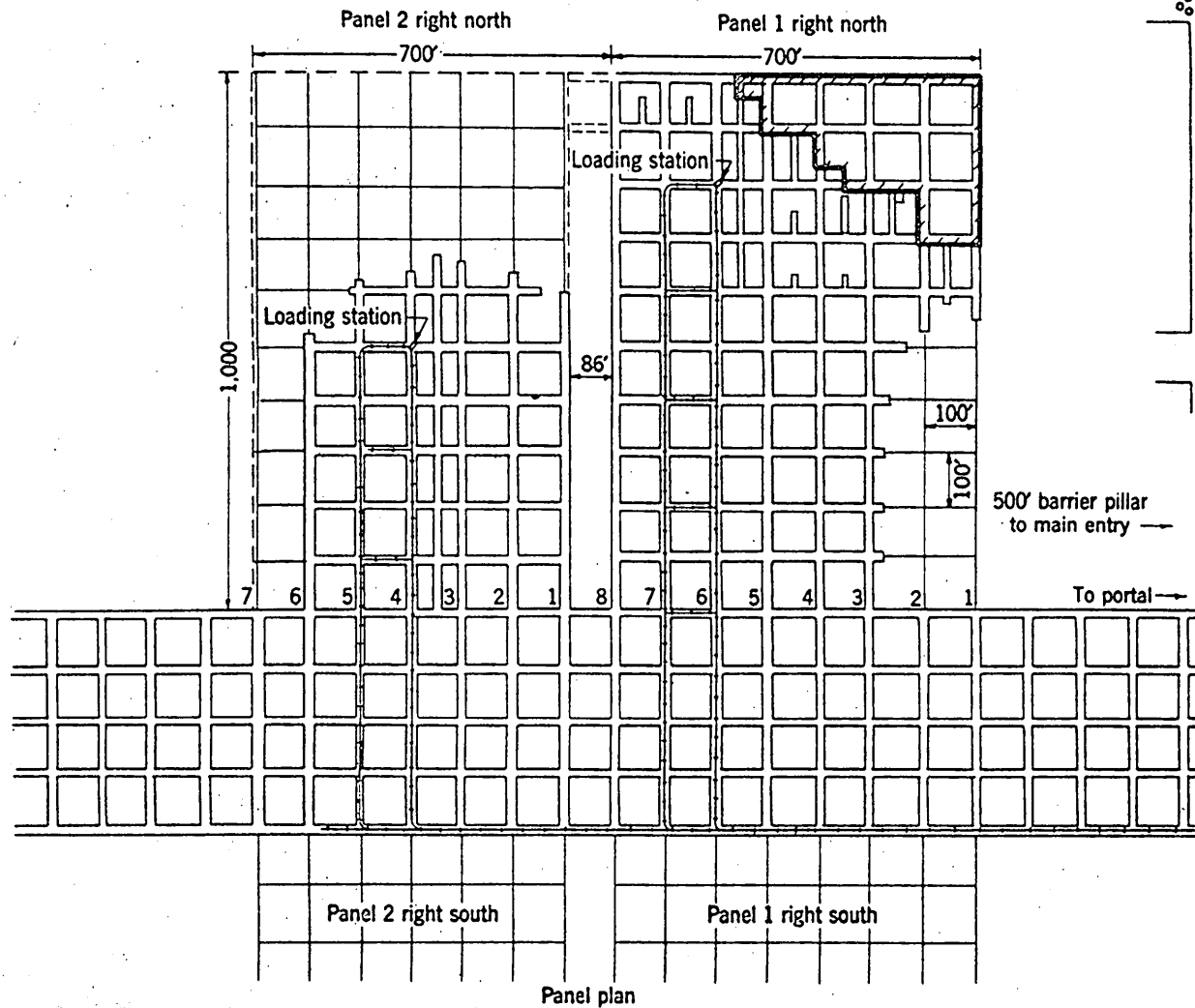

Figure 42

Layout of panels and method of extraction of pillars in Room and Pillar workings (43)

completely mined and a roof fall occurs. This practice prevents loose gob from rolling into the working place and also lessens the possibility of the fall extending into the split. After the split has been completed and the pillar has been divided into blocks, the block next to the gob is extracted in lifts. Lifts A and B are mined in succession and lifts C and E are mined together. Lifts F and D then are mined together, and G and H are mined in succession. The stump or "push out" in each block is recovered as shown in the cutting sequence. A small triangular stump is left on the gob side of the first cut in each lift to keep the loose gob from mixing with the coal and to give additional support to the overhanging roof. The coal is top cut, and a shear cut is made next to the stump to separate it from the first cut in the lift. When possible, the remaining cuts in the lift are open ended. However, if the timbers or stump show signs of roof pressure, additional stumps are left along the gob side of the lift. The timber crew then sets five breaker props in the split and in line with the rib of the next lift. If a roof fall does not occur immediately, the stumps are blasted. Figure 43 shows the loading arrangement and track layout in the panel.

A plan followed in mining rooms and extracting pillars in a panel with continuous miner is shown in Figure 44. The cuts, comprising a complete mining cycle are indicated by the broken lines. These cuts are mined in the sequence indicated by numbers 1 to 23, inclusive. The solid lines

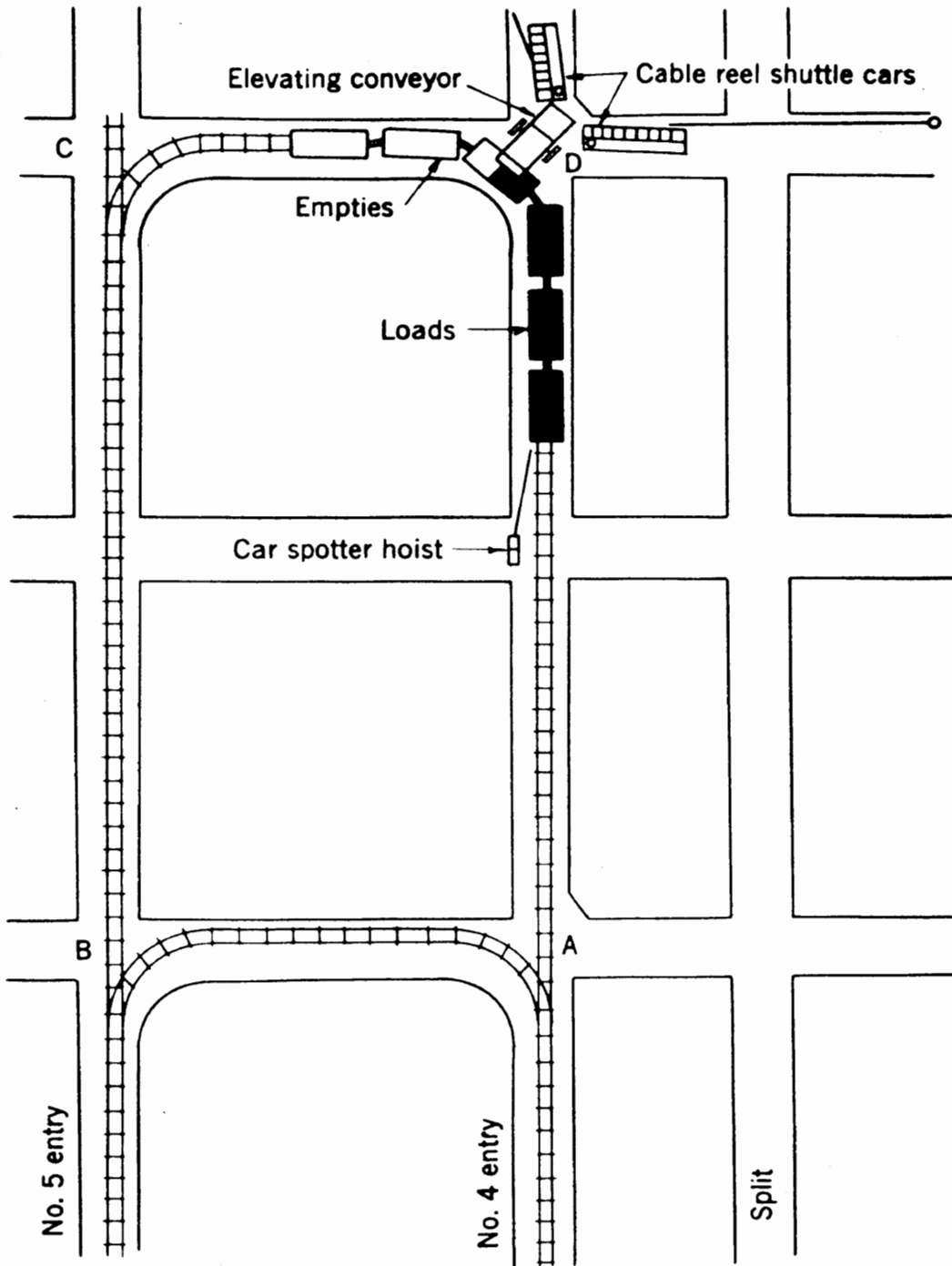

Figure 43

Loading station and track layout (43)

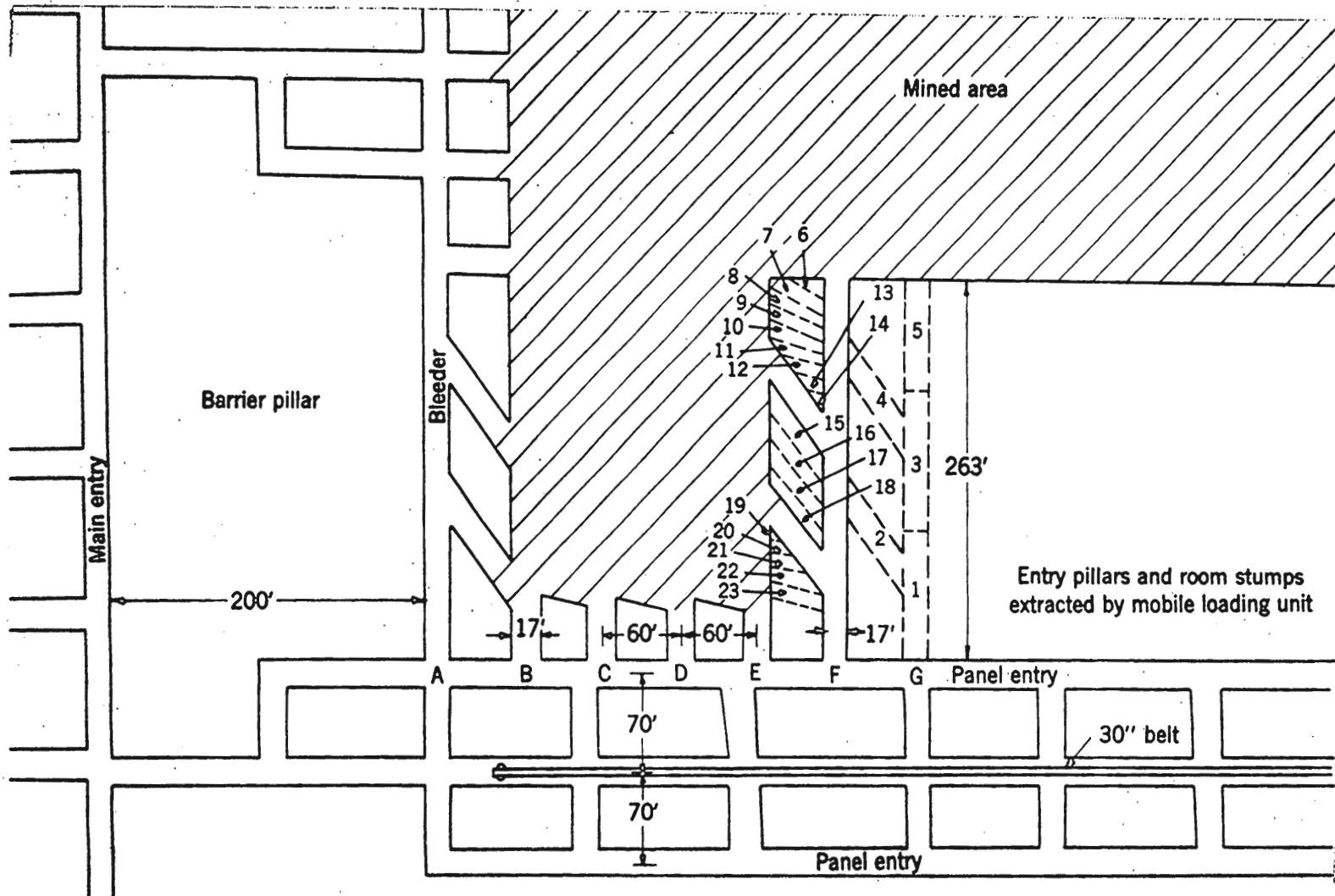

Figure 44

Plan showing sequence of extraction of pillars by Continuous Miner (21)

show the coal faces at the beginning of the mining cycle. Before the pillars between rooms E and F are mined, room G is driven to provide an escapeway. A row of room pillars is left around the panel to provide a bleeder. The panel entry pillars and the room stumps are extracted by a mobile loading unit as the rooms are retreated by the continuous mining machine. Rooms, entries and cross-cuts are driven by making alternate cuts as shown in Figure 45. Wood props are set along the center of a completed cut on 4-foot centers. These props are reset when the alternate cut is completed and then reset along the right rib as the continuous-mining machine advances. On pillar extraction, wood cribs are set along the gob side of each lift. These cribs are recovered and moved forward with each successive lift. The continuous mining unit consists of a continuous mining machine, two cable-reel shuttle cars, and one belt conveyor. The miner loads the coal onto shuttle cars which transport the coal to the belt conveyor in the panel entry and, at the discharge end of the belt conveyor, coal is loaded onto mine cars.

Another layout for the extraction of a panel by continuous-mining machine is shown in Figure 46. When the panel entries have reached a predetermined boundary, rooms are turned up the dip. The two inbye rooms (A and B) are mined simultaneously by making cuts 1 to 6, inclusive. The pillars between these rooms are extracted as shown by cuts 7 to 15 and room C is mined by making cuts 16, 17 and 18. Mining in

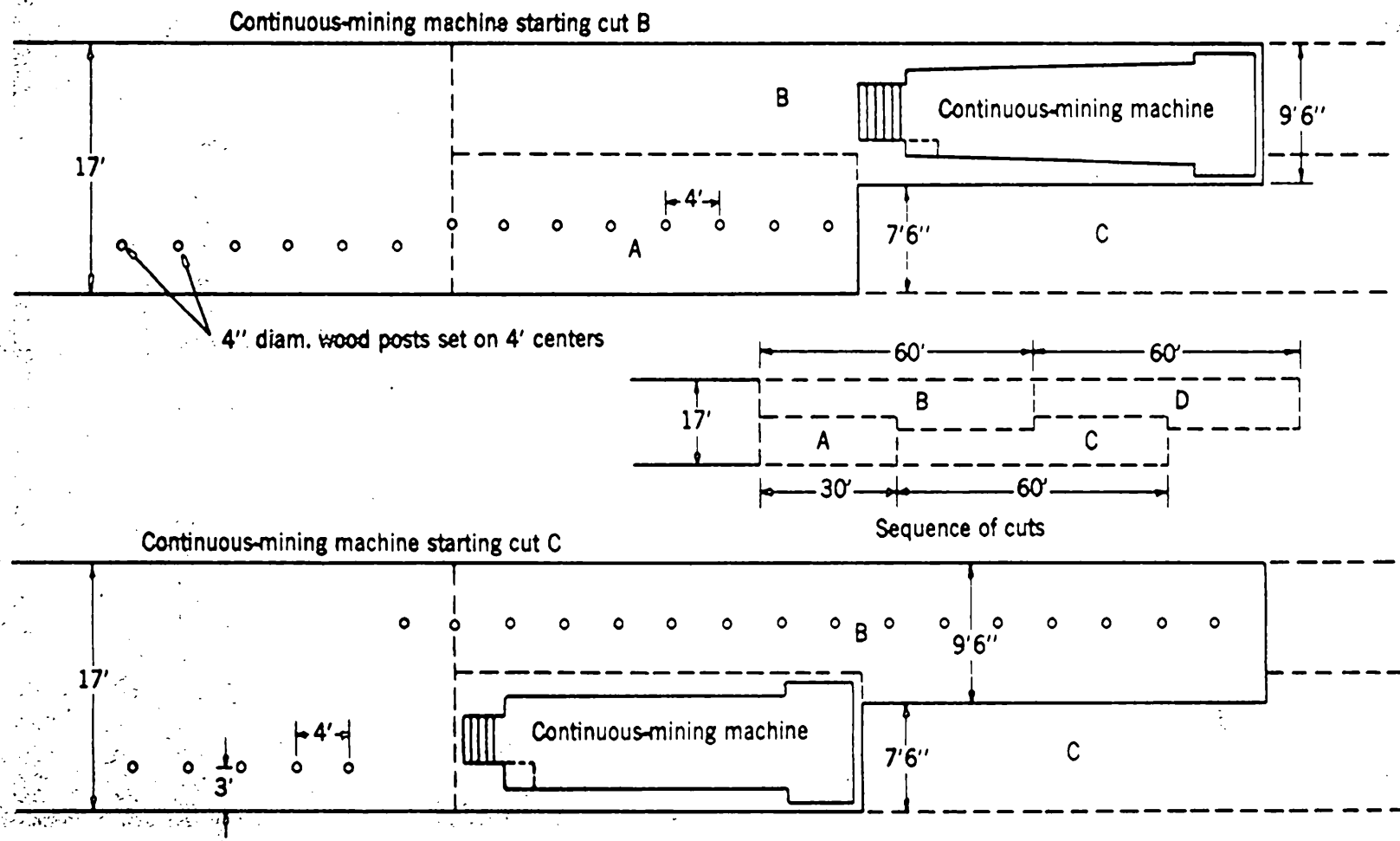

Figure 45

Sequence of cuts in roadways with Continuous Miner showing support system (21)

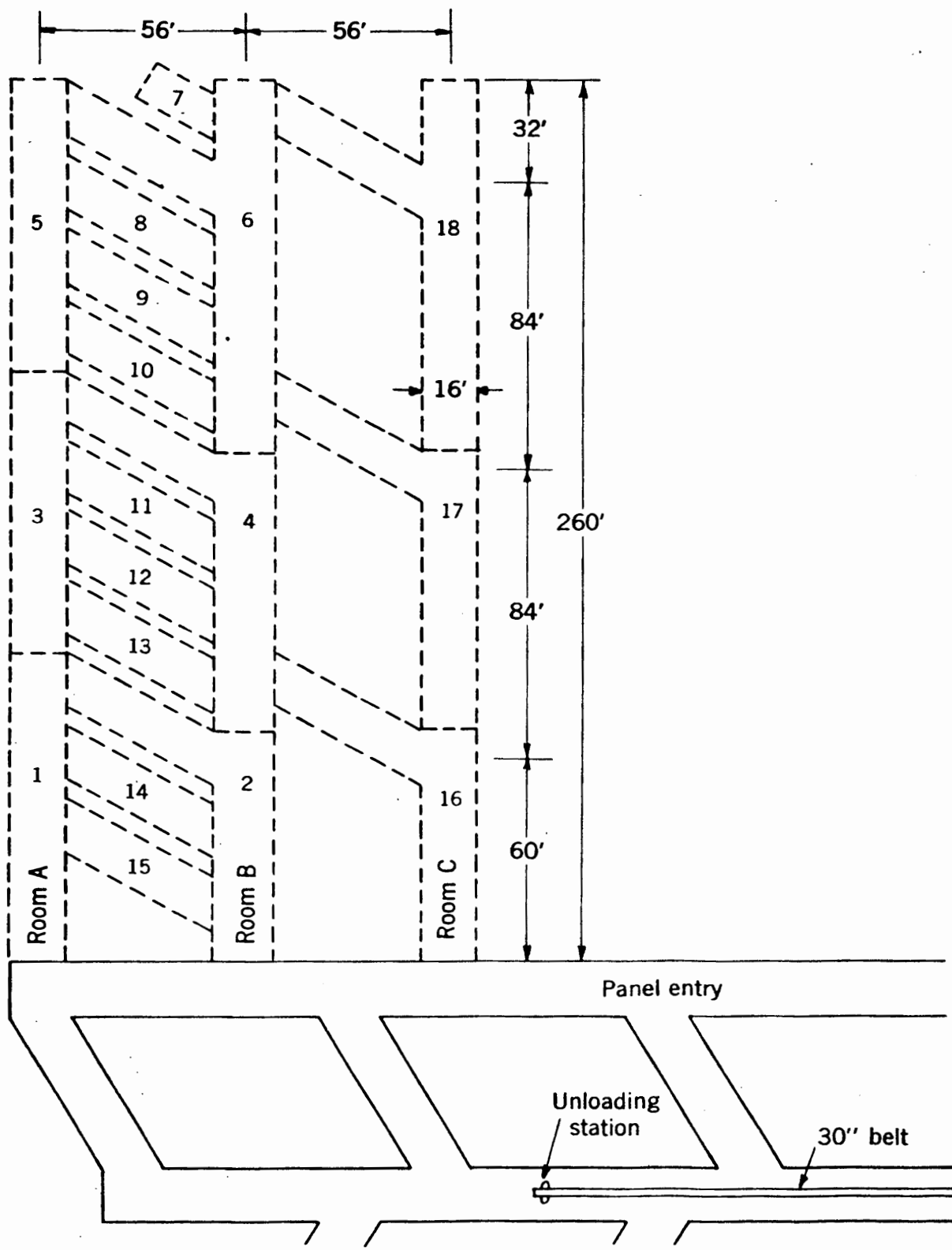

Figure 46
 Plan showing sequence of extraction of pillars by Continuous Miner (21)

the panel proceeds by repeating the cycle of cuts 7 to 18, inclusive. Panel entry pillars are extracted by making cuts similar to those made in extracting the room pillars. A single row of wood props on 4-foot centers is set in rooms 4 ft. from the rib and, in pillar extraction, a single row of wood props is set along each rib. The continuous mining unit consists of a miner, two cable-reel shuttle cars and a belt conveyor. One of the shuttle cars is used as a surge car, and the other transports the coal from the surge car to the unloading station. The shuttle car is equipped with an elevating conveyor which discharges the coal onto the belt conveyor.

The layouts in pitching seams have to be oriented and suited to the type of haulage and face machinery to be used. Mobile face equipment can be used only to certain limiting pitches and, if the pitch is greater, they cannot be applied and different sets of machinery have to be used.

The method of extraction in a seam pitching at 15° thru 28° (1 in 3.7 thru 1 in 1.9) is shown in Figure 47. The panel entries are driven to a predetermined boundary along the strike. Rooms are turned at 90° off the air course entry and are driven up the pitch of the bed. A working section consists of three rooms - two advancing and one retreating on the pillar. A compartment comprising manway and conveyorway is securely timbered along the inbye side of the rooms by erecting timber sets consisting of props and bars as shown in the figure. The area of the room

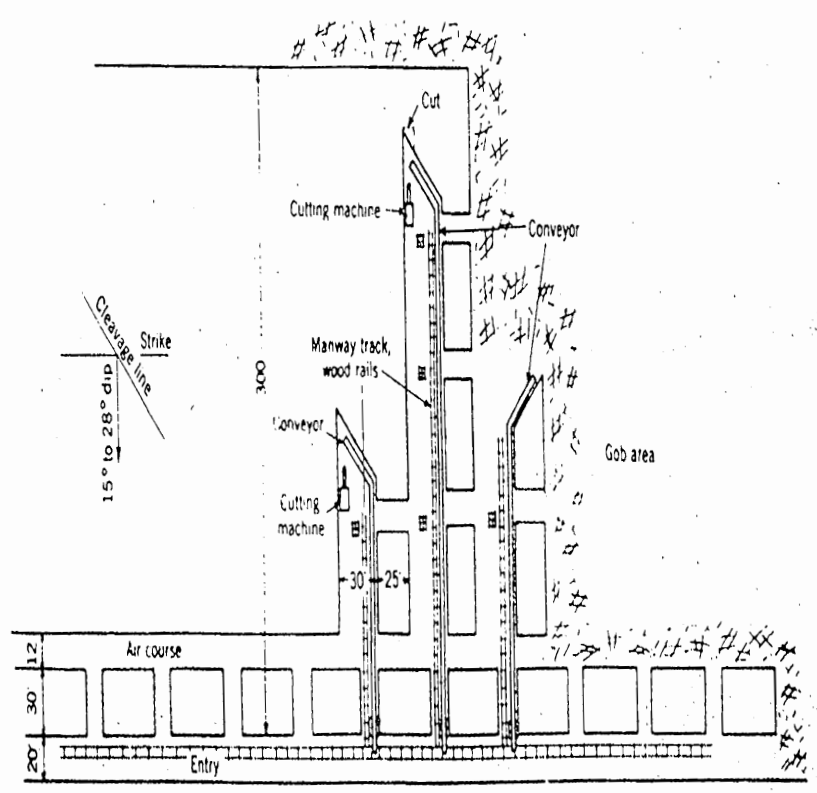
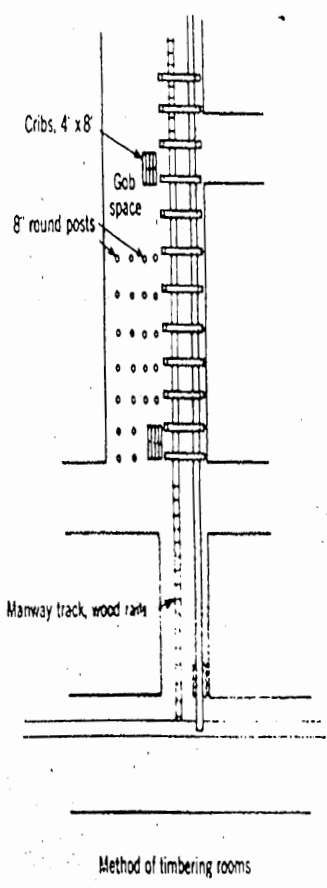
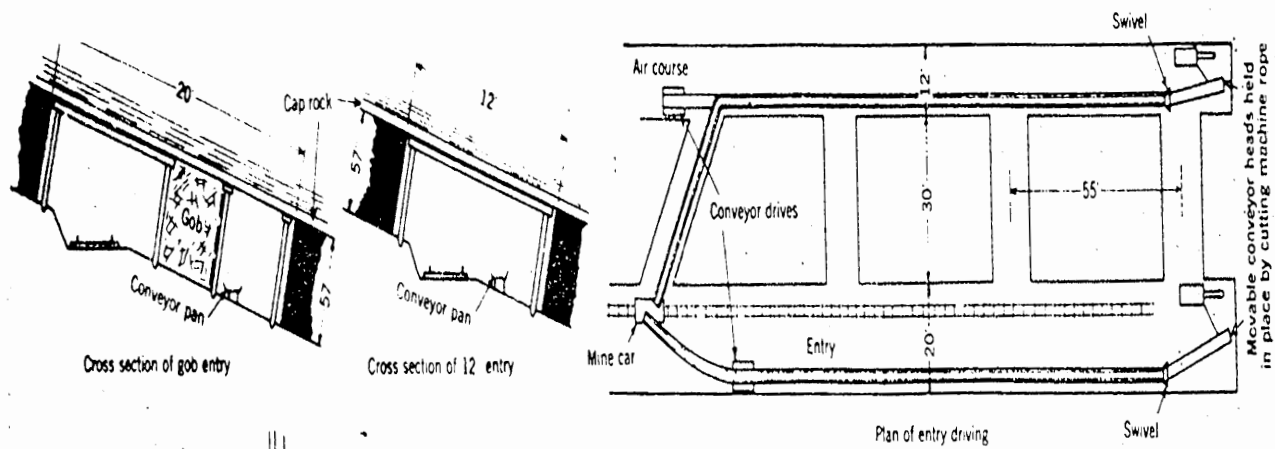
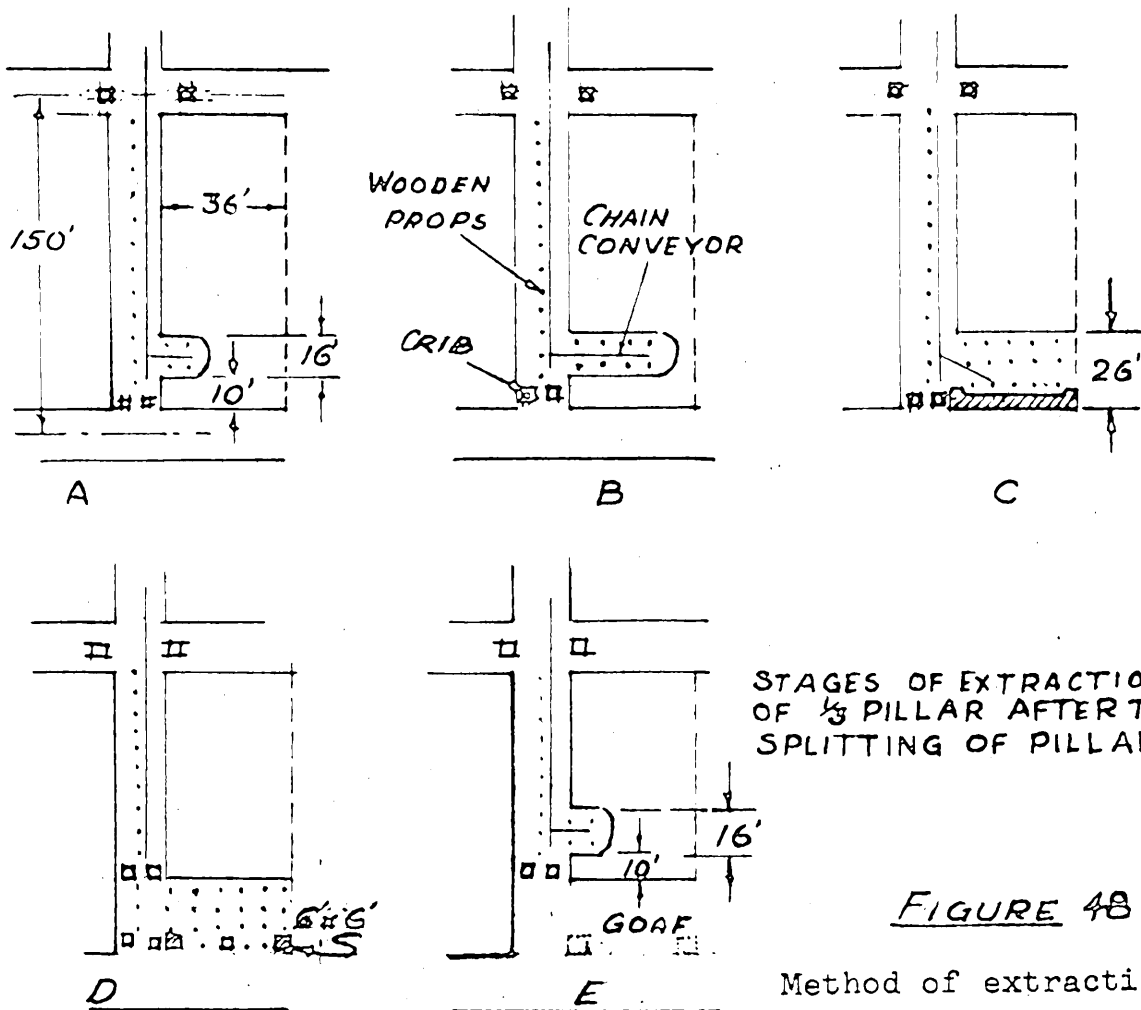
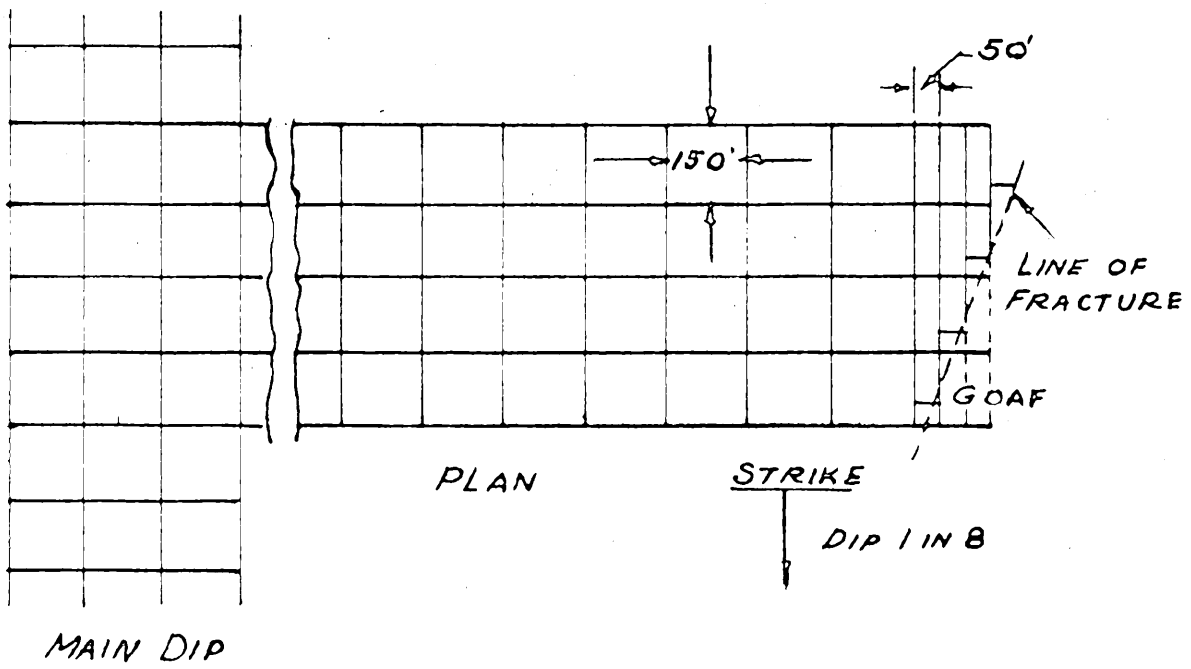

Figure 47

Method of extraction in Room and Pillar workings in steep seam (41)

outside the manway is timbered with props on 4-foot centers. A crib is placed adjacent to the manway at each room cross-cut. All coal is loaded onto shaker conveyor which is installed in the conveyorway adjacent to the inbye rib of the room. A material track is placed in the manway compartment. The cleavage in the bed results in forming a face approximately 45° to the direction of the room. The loading pan of the conveyor is turned along this face by means of a swivel. Pillars are extracted by mining across the pillar at an angle of approximately 60-degrees off the center lines of the rooms. All places are well timbered adjacent to the conveyor line at the face. Each working place is equipped with a cutting machine, portable drill and supply track. A sheave is attached to a timber at the head of the supply track in each working place, and one electric hoist handles supplies and material for three working places. Coal is hand shoveled onto the face conveyor.

A method of extraction in a seam pitching at about 7° (1 in 8) at a depth of about 2000 ft. is shown in Figure 48. The panel consists of five parallel headings driven along the strike of the seam up to a predetermined boundary forming pillars which are on 150 ft. centers and which are extracted on the retreat. Each pillar is divided into three blocks or stocks by two dipping splits as shown in the plan. The sequence of extraction of the blocks is so arranged that the direction of the line of fracture is



STAGES OF EXTRACTION
OF $\frac{1}{2}$ PILLAR AFTER THE
SPLITTING OF PILLAR.

FIGURE 4B

Method of extraction of
pillars in a moderately
pitching seam (100)

maintained constant. Each block is taken in slices from the goaf end, the sequence of extraction of each block being shown in stages A, B, C, D and E. The coal is cut by a skid mounted shortwall coal cutting machine, drilled by a portable electric drill and blasted. It is hand shoveled onto the face chain conveyor which feeds the room chain conveyor. The room chain conveyor, in turn, loads onto the main belt conveyor which is installed in the middle heading on the strike. Supports are set as shown in the figure. This type of face machinery and the method of extraction can be adopted in seams ranging from level to pitches as high as about 18° (1 in 3) beyond which the coal cutter will skid.

A method of extraction in a seam pitching at 45° (1 in 1) is shown in Figure 49. Pairs of panel entries, comprising haulageway and airway, are driven off the slope along the strike of the bed. An opening, similar to room entries, comprising manway and air-course, is driven from the airway of the lower entry to the haulageway of the entry above. A ladderway, chute and 12-inch gage material track are constructed in the manway. Rooms are turned from the manway compartment along the strike of the bed. These rooms are driven 35 ft. wide with 30 ft. pillars in between. Extraction of a panel is started in the chain pillar of the top entry. A shaker conveyor is erected on the high side of the working place adjacent to the pillar. Successive diagonal slices are taken off the pillars by blasting to

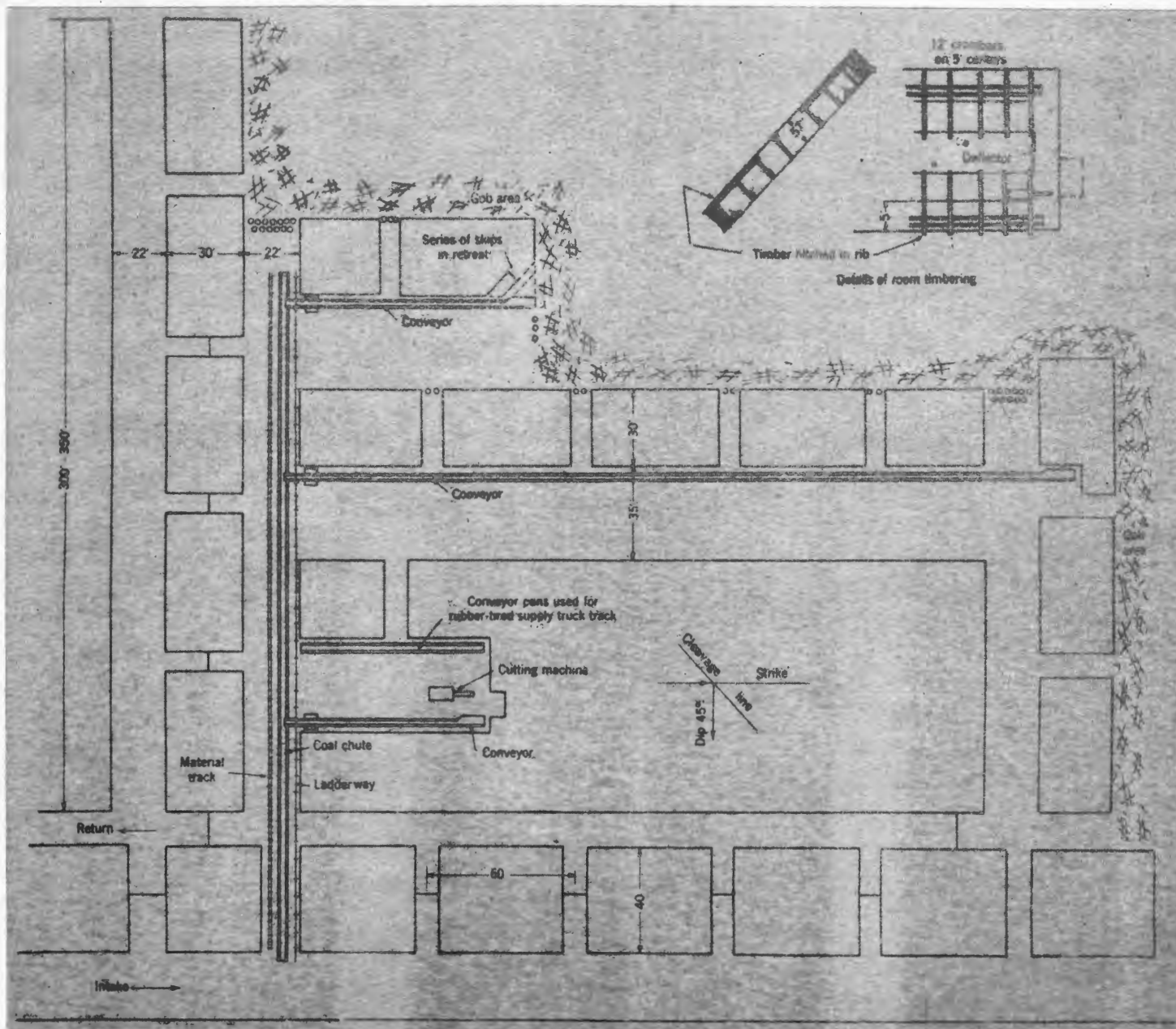

Figure 49

Method of extraction of pillars in a highly pitching seam (41)

the open side. The coal usually flows by gravity to the loading pan of the conveyor. Only a minimum amount of shoveling is necessary. The conveyor discharges coal onto the chute.

Three rooms are worked simultaneously off an inclined plane - two on the advance and one on the retreat. A conveyor is erected along the lower rib of the room during the advance of the place. Conveyor pans are laid along the upper side of the room and serve as a materialway during the driving of the room. A small rubber-tired truck is operated in this pan line. This conveyor is used later when the room pillars are extracted. Each working place is timbered with two parallel sets of timbers as shown in the figure. Temporary sets are used between the permanent timbers and the face.

A cut, 6 ft. deep and 8 ft. wide, is made with a shearing machine beginning at a point approximately 5 ft. from the lower side of the place. It is unsafe to cut the entire face in the steep pitch workings. The machine is kept on an adjustable mounting that maintains the machine in a horizontal position and this mounting rests against lagging placed against the props on the lower rib side as shown in the figure. The face is drilled and blasted. The loading pan of the conveyor is advanced onto the bottom coal. After this cut has been loaded, the remainder of the face is mined toward the open end. A plank deflector is laid between the face and the timbers to guide the coal to

the loading pan of the conveyor. Only a minimum of shoveling is necessary as the greater part of the coal flows onto the conveyor by gravity.

In seams pitching at 25° to 45° , a method of extraction may consist of two levels, one for intake and haulage and the other for return. They are driven in the seam and connected to the shafts by cross-measure drifts. A pair of roads is then driven to the full rise for some 100 to 150 yards and then short "breastings" are driven on the full rise and dip of the seam and advanced along the direction of the strike, roughly 10 yds. in length. A series of such breastings are driven with the uppermost face leading as shown in Figure 50. Packing of the gates is a special problem and packs are interlaced with wood cribs to prevent them from sliding down the dip before roof subsidence can consolidate them.

Thick Seams

Seams of greater thickness present a special problem and call for special methods of working. The methods applied vary greatly and depend upon the depth, thickness, pitch and nature of coal and the nature of the immediate strata.

The method of extraction of a 16 ft. thick seam pitching at about 8° (1 in 7), at a moderate depth, is shown in Figure 51. The seam is developed in the floor level for a height of 8 ft. and the rest of the coal is taken during depillaring on the retreat. As the depth is not very great the pillars are split into four blocks and the blocks are

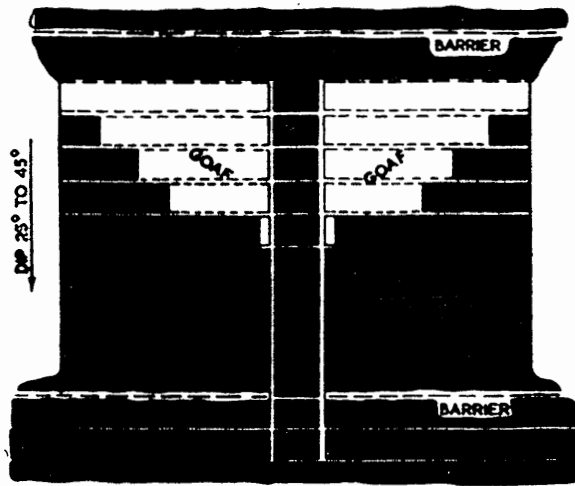

Figure 50

Method of working steep seams with
"breastings" on the strike (37)

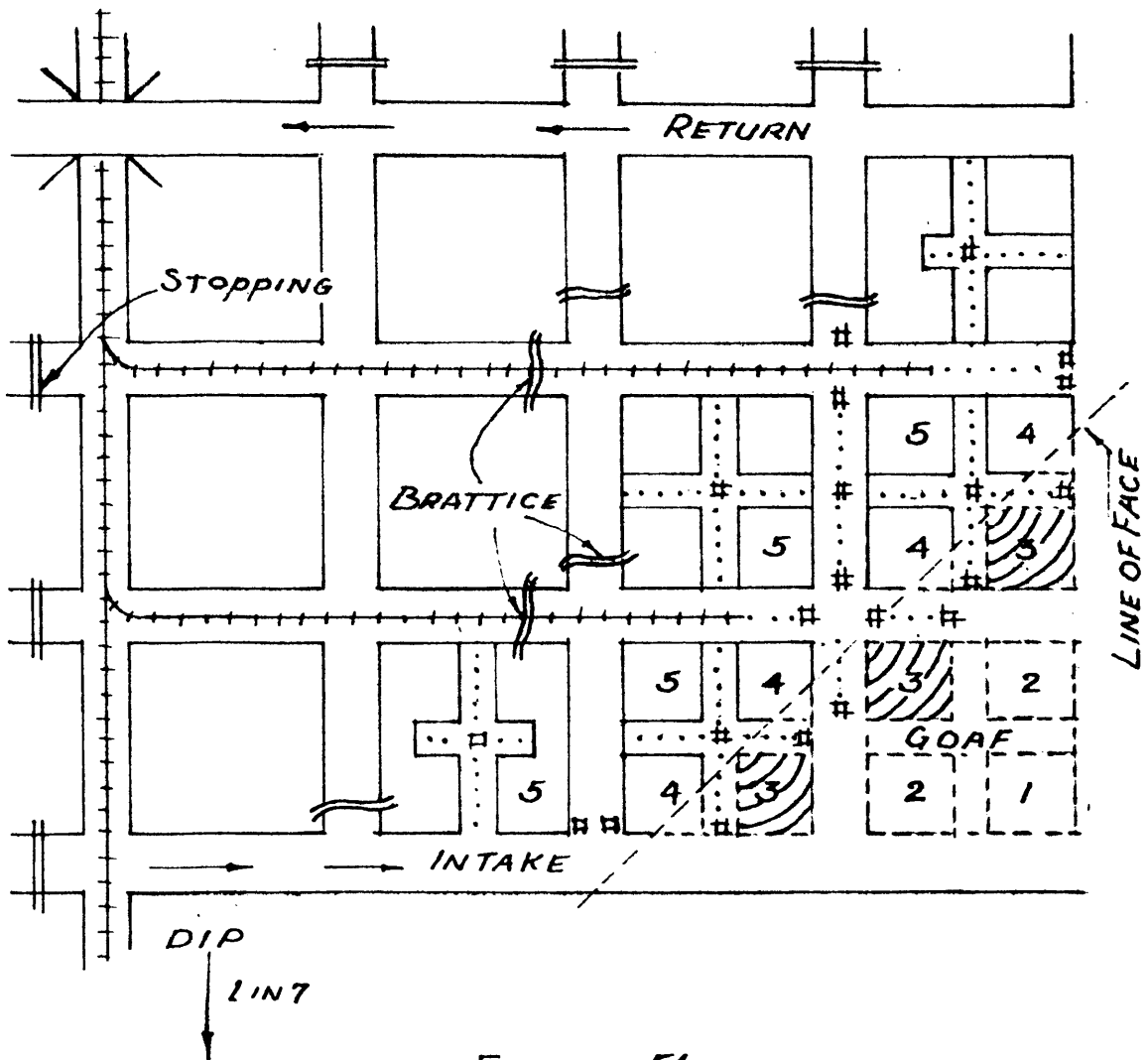

FIGURE 51

Method of extraction of pillars at
at shallow depth (106)

taken in a diagonal fashion. The block to be attacked is prepared by brushing the 8 ft. of the roof coal on two sides of it in the splits and supporting the roof by props as needed. After the two sides have been fully heightened, the 16 ft. high block is attacked from the rise side by blasting; holes being drilled with a hand held electric drill. Extraction of the block is continued in a half-moon fashion and props are set systematically as extraction proceeds. The sequence of extraction of blocks is always maintained to get the correct line of face.

If the mine shown in Figure 48 is deep and the thickness is 15 or 16 feet, the method of extraction will be the same as described. In that case, after splitting the pillar into 3 blocks by driving two 8 ft. high splits in the floor level, the dip split adjoining the block under extraction is heightened the ultimate maximum and supported by 16 foot props. Then 16 foot high slices are taken as before.

The method of extraction of a seam 9 to 16 ft. thick, dipping at 23-degrees, is shown in Figure 52. Rooms are turned on 70 ft. centers from each entry. They are developed in groups of three and driven up the dip at 90-degrees with the strike of the bed. A barrier pillar of 140 ft. is left between each group of three rooms. The height of the room is the thickness of the coal seam. Where the bed reaches the maximum thickness of 16 feet, rooms are driven 8 ft. high on the advance and the top coal is taken down on the retreat from the roof. Steel chutes extend from the face

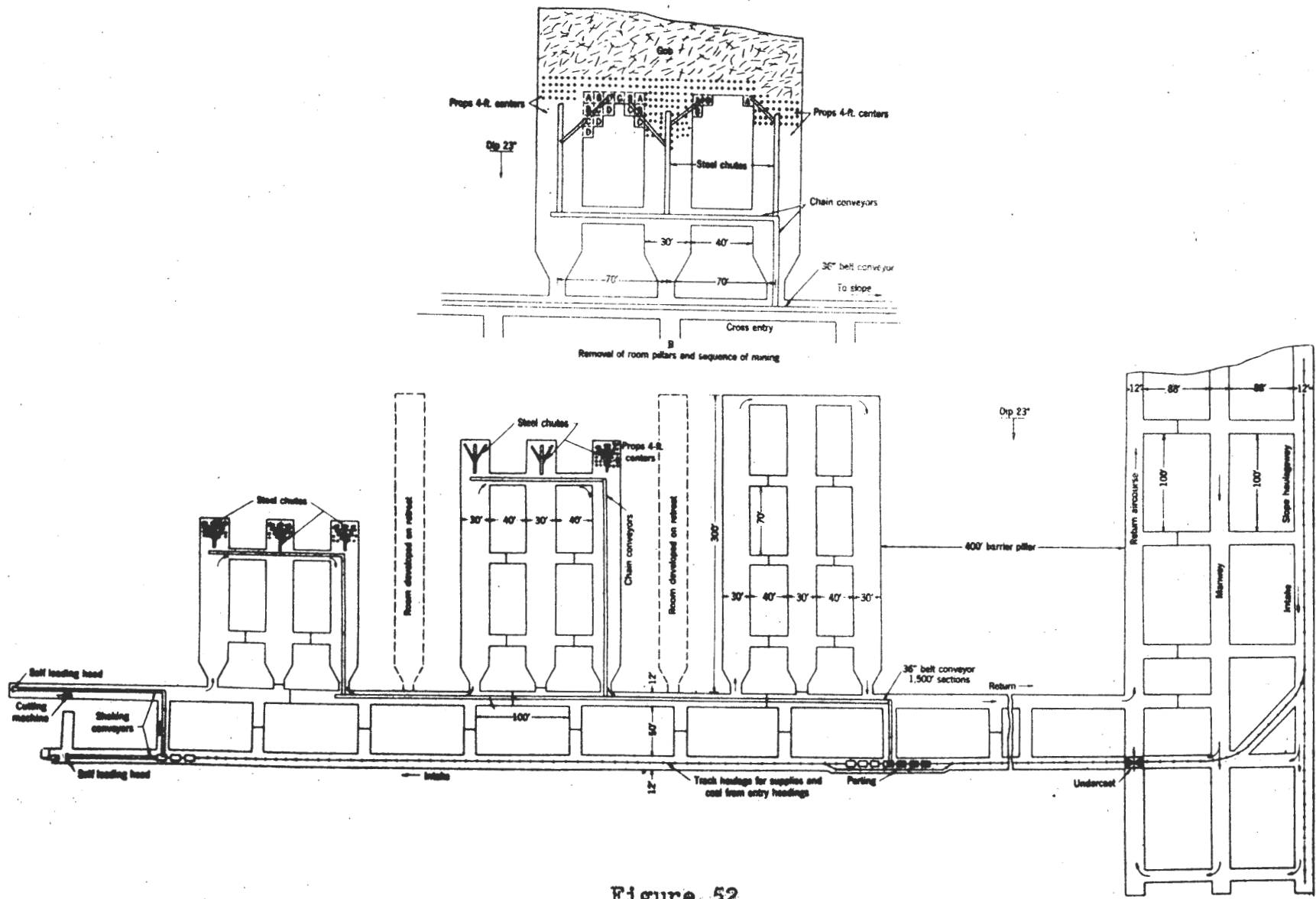

Figure 52

Mining method in a seam pitching at 23° (41).

of the room to a chain conveyor in the inbye cross-cut. This conveyor extends across the three rooms to a chain conveyor in the outbye room and the coal is conveyed to the belt conveyor in the entry. Extraction of pillars is started on the retreat when the three rooms are driven up to the predetermined limit. The line of face in the depillaring area is maintained diagonal as shown. The fallen coal is shoveled and pushed over the steel chutes that are placed in the rooms and along the working faces to cross chain conveyors in the next outbye cross-cut. The cross conveyor and room conveyor transport the coal to the belt conveyor in the entry.

The percentage of extraction from a thick seam by caving in room and pillar workings is low but if packing is adopted, a very high percentage of extraction can be attained. Following is an example of the method of extraction of a 28-foot thick seam at a depth of 600 ft. to 800 ft. from the surface in which sand stowing is practical. The development was done on the floor level for a height of 7 ft. Rooms are 12 ft. wide and pillars are 100 ft. on centers. The seam is extracted in four 7-ft. high lifts.

During the extraction of pillars, small areas - each enclosing about 16 pillars are worked as a unit. The pillar under extraction is first split into two by driving a level split 7 ft. high and about 12 ft. wide. The dip-side half-pillar is then extracted in three slices as shown in Figure 53. The first slice is taken out and stowed before the

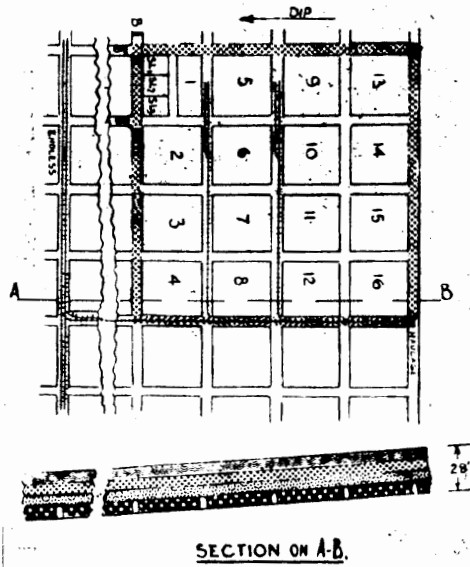
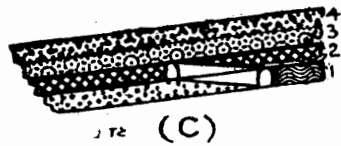
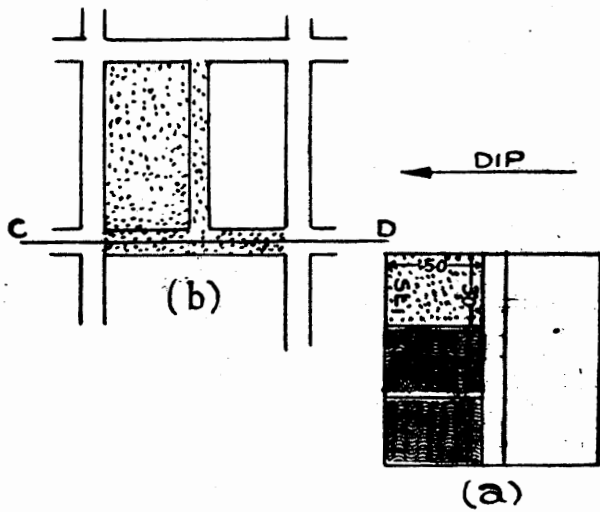

Figure 53

Mining method in a seam 28 feet thick with

hydraulic stowing
(10)



SECTION ON C-D

Figure 54

second slice is attacked (Figure 54a). The arrangement of barricades, b, erected before starting the stowing, is shown in Figure 53. When the first lift of the dip-half of the pillar is extracted, the dip gallery CD (Figure 54b) is partially packed with sand to provide a level track from the level gallery in the first lift to the split gallery position in the second lift. After the track is laid on the sand floor, a level split is driven in the second lift (Figure 54c) and the track extended therein. The extraction of the dip-half of the pillar in the second lift follows the same pattern as that in the first lift. As soon as coal extraction is started in the dip-half of Pillar 1, a split gallery is started in Pillar 2, and when the extraction of Pillar 1 is started in the second lift, the extraction of first lift is started in Pillar 2.

When the second lift has been extracted and stowed in the dip-half of Pillar 1, the track in the dip gallery between Pillars 1 and 2 is raised on a slight gradient from the level gallery in the first lift so as to reach the third lift. This, however, necessitates removal of some roof coal from the original dip gallery, which has now become a slightly rising one (Figure 55a). As may be seen from the figure, this gallery now touches the third lift not in the center of the pillar but a little on the dip side so that the dip-half of the third lift is about 30 ft. wide and the rise-half is about 46 ft. wide. The track position for taking out the third lift in the dip-half of Pillar 1 is as shown in Figure 55a.

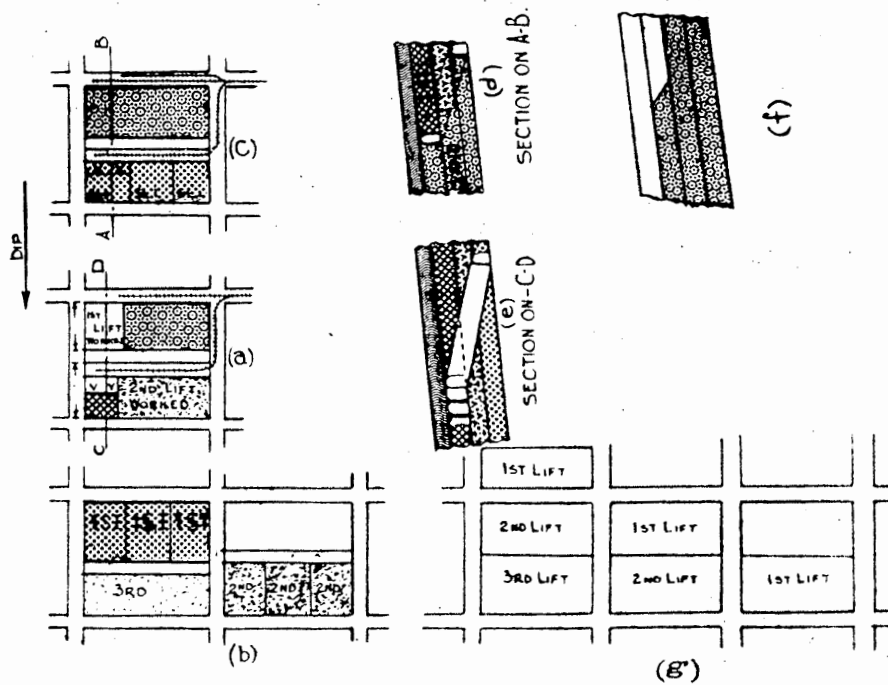

Figure 55

Mining method in a seam 28 feet thick with hydraulic stowing (10)

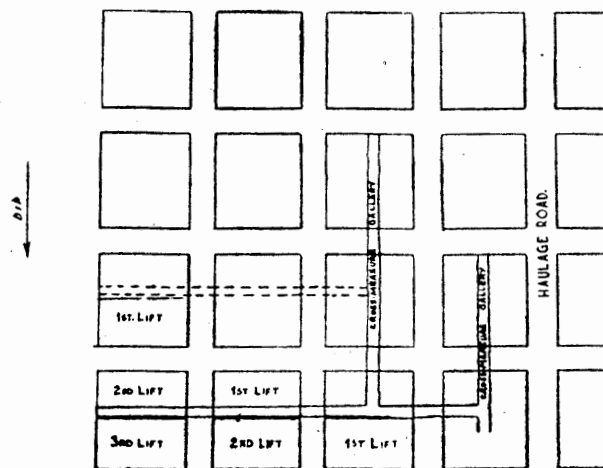

Figure 56

Mining method in a seam 28 feet thick with hydraulic stowing (10)

When the split gallery in the third lift is driven and the dip side coal has been taken, the position is such that the full pillar has been extracted in the first lift, the dip-half pillar has been extracted in the second lift and the dip 30 ft. of coal has been extracted in the third lift.

Now, working from the same split gallery in the third lift, coal is extracted towards the rise side of the pillar until the level of the roof of the second lift on the rise half of the pillar is reached. From this point, the slice driven forward in a dipping course in order to extract the coal in the second lift in the rise half of the pillar. When this second lift on the rise half of the pillar has been taken out and stowed, Pillar 1 is left in the position shown in Figure 55f. At this stage, the position of extraction of different lifts in different pillars is as shown in Figure 55g.

As the extraction of coal in the fourth lift of Pillar 1 is not possible from the adjacent level gallery, it is necessary to drive a couple of cross-measure galleries from the rise-side level galleries (Figure 56). It is essential that this pair of cross-measure galleries and a level along the strike, as shown in the figure, are ready before the fourth lift in Pillar 1 can be extracted.

Figure 57 shows the position of the track for the extraction of the fourth lift in the dip-half of Pillar 1. It also shows, in dotted lines, the level gallery which will

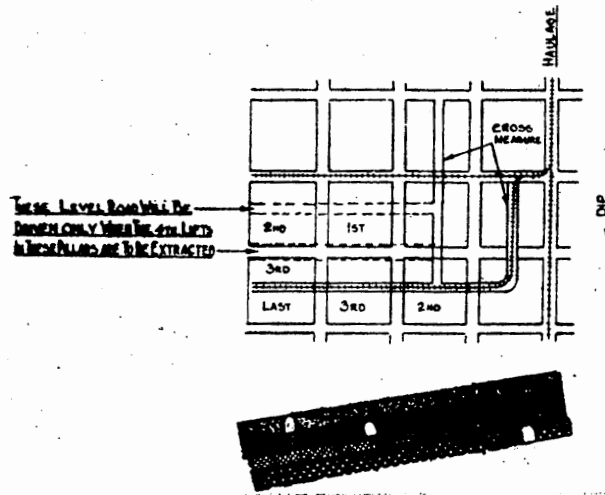
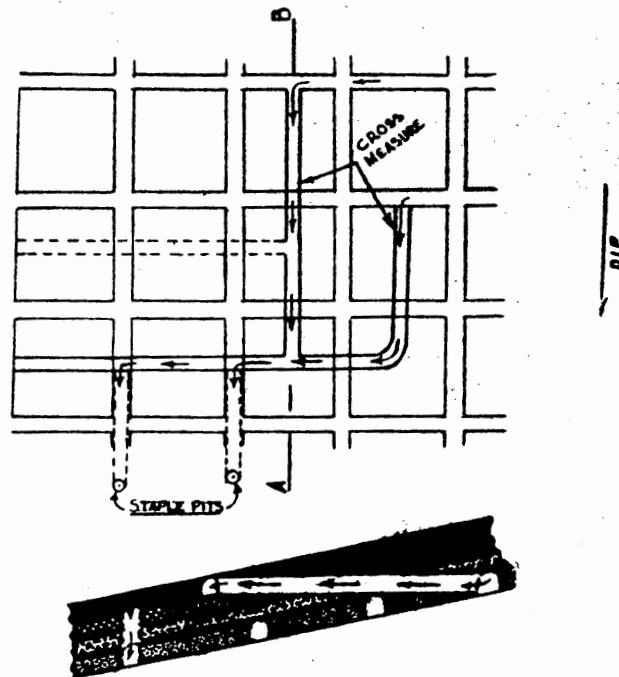

Figure 57

Mining method in a seam 28 feet thick with hydraulic stowing (10)



SECTION ON A-B

Figure 58

Mining method in a seam 28 feet thick with hydraulic stowing (10)

have to be driven in the top section of the seam in order to extract the last lift in the other pillars. The position of track for extracting the various lifts in different pillars has been shown in the various figures. Their grades are always in favor of the load. The track is laid as near to the working faces as possible. Empties are hand trammed into the working faces and loads are gravitated down to the haulage curve. There is no problem in ventilation during the extraction of the first three lifts but the workings in the fourth lift, however, have to be ventilated through the cross-measure galleries and staple pits as shown in Figure 58.

The mine has been developed in the first lift by using coal cutting machines and permitted explosives, but during the pillar extraction all work is done by pick mining. Under these conditions pneumatic picks can be used without difficulty to give higher outputs. As the area exposed at any one time is only about 30 ft. by 40 ft. there is no difficulty in supporting the coal roof in the first three lifts. During the extraction of the fourth lift, however, special care has to be taken to support the immediate roof of shaly sandstone which has a prominent cleavage. Systematic timbering rules have to be followed and enforced at all stages during the extraction of pillars. About 1.4 tons of sand are stowed for every ton of coal extracted. The extraction is 100 percent. Although the extraction was under buildings, tanks, etc., no subsidence has been noticed.

Suggested Methods of Pillar Extraction

If a seam is less than 16 ft. thick and at a moderate depth, it can be developed along the floor level up to a height of about 8 to 10 ft. The pillars are divided into four blocks each by driving two splits, each about 12 ft. wide and of a height equal to that of the rooms which were made during development. The adjacent pillars are split during extraction of the blocks as shown in Figure 59a. The junction O is heightened to the main roof and then the roof coal is taken from the two splits along the direction of the arrows as shown. If roof is bad, a portion of the roof coal at the goaf end of the split is left (Figure 59c). This bridges the roof between the blocks and, thus, serving as a bond which reduces roof trouble. Moreover, it reduces also the height of the cribs that are set at these points. After heightening these splits, the Block 1, Figure 59a, is extracted at full height. When Block 1 is taken, Blocks 2 are extracted and the same procedure is adopted for extracting other remaining blocks.

This method is applied when the roof conditions are fairly bad and, thus, the exposed area of the roof is kept at a minimum. Otherwise, if the roof is good, a modification of this method can be applied in which case the junction of the pillar at X (Figure 59a) is heightened and, from this junction roof coal is taken in the direction of the level and the dip rooms adjoining the pillar under extraction. The pillar is then divided into four blocks

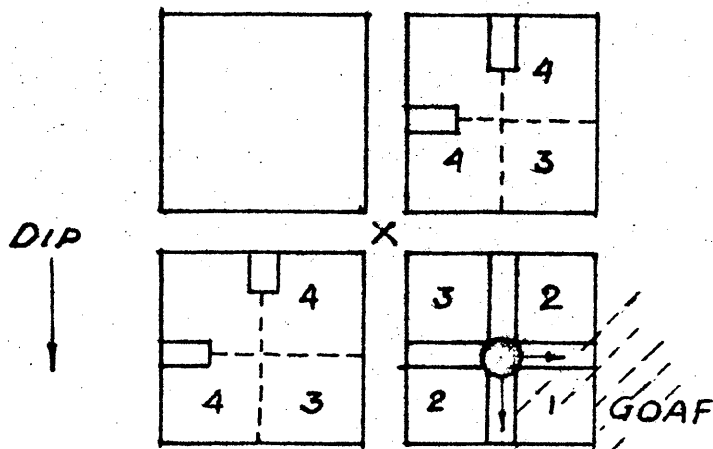

FIGURE 59a

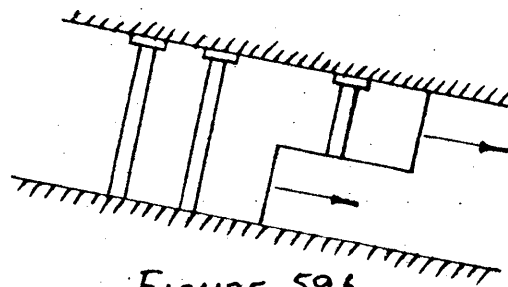

FIGURE 59b

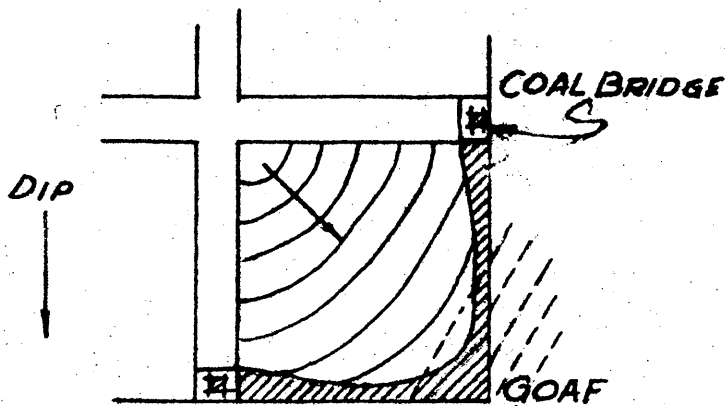

FIGURE 59c

Methods of extraction of pillars at shallow depth (117)

by driving two 16 ft. high splits and, finally, extracting 16 ft. high blocks along the line of face adopted.

If the roof parts quickly, heightening of rooms is not done in advance but just when it is needed. In no case is heightening permitted in advance in more than one pillar.

The high blocks or stooks can also be taken in benches proceeding along the strike or along the dip towards the goaf (Figure 59b). The advance of the upper bench is usually kept at about 6 to 8 ft. The blocks can also be taken in half-moon fashion as shown in Figure 59c.

In deep mines, the stresses due to front abutment pressure on the pillars are quite high. In such cases, the best practice will be to extract pillars in slices which are taken along the goaf edges where the coal is in a distressed condition. This coal is easy to get because the area of exposed roof is kept at a minimum by this method. Thus, the chances of premature collapse or overriding of pillars are greatly reduced. Slices of pillars can be taken in different ways depending upon the direction of cleats, nature of coal and the immediate strata and pitch of the seam. A number of such variations are shown in Figure 60. The arrows show the direction of advance of extraction and the numbers indicate the sequence of extraction of slices.

Longwall Advancing System

In longwall advancing, a continuous line of working face advances in one direction towards some predetermined

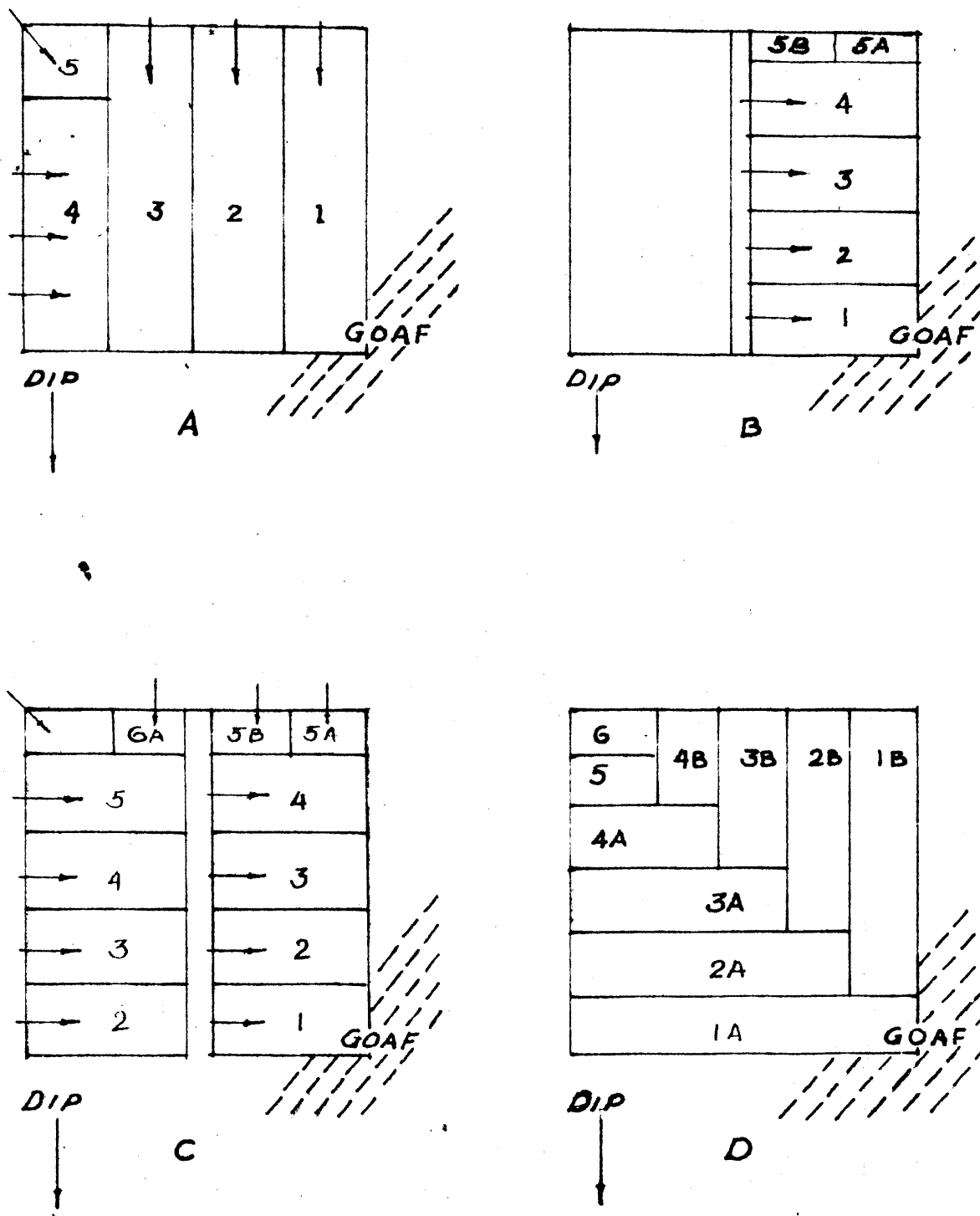

FIGURE 60

Methods of extraction of pillars in deep mines (119)

boundary and thereby leaving behind an area of "waste", "goaf" or "gob". The face may be straight or stepped. The sides of the roads, leading to the coal face along which coal is transported and men and material pass, are supported by roadside packs. In the area of the goaf, roof is allowed to cave in, or where controlled subsidence is desired, strip packing, i.e., alternate packs and wastes, is done. In other cases, where no or little subsidence is desired due to presence of contiguous seams above or buildings, etc., on the surface, complete packing of the goaved out area is done by either hydraulic, pneumatic or mechanical stowing. The gate roads which are maintained for haulage and ventilation must be enlarged from time to time in order to maintain the desired cross-sectional area. This depends upon the depth and thickness of seam, nature of roof and floor, and quality and quantity of packing. Such effects may be diminished by complete packing but cannot be eliminated altogether.

This system of mining aims at complete extraction of the seam in one operation. The actual percentage of extraction depends upon the system of supervision and organization and avoidance of leaving coal in any form in the wastes.

Seams as thin as 12 to 14 inches thick can be worked by longwall with the type of machinery that is now available. Seams that were unworkable due to thinness at one time are now considered workable economically and safely

as a result of development of mining machinery for thin seam workings. Coal cutting machines are now available whose minimum height is 12 inches. Coal plows have been developed which can be used in thin seams. Conveyors of the jiggling type or specially constructed belt or chain type are now available whose overall height is only 6 inches. On the other hand, thick seams, over 8 ft. or so in thickness, are not easy to work in one lift by longwall. Control of roof in thicker seams is difficult and requires careful planning. In India, some thick seams in deep mines are being worked by longwall advancing with hydraulic sand stowing in the first lift of 8 ft. and the remaining coal over the sand is taken by room and pillar.

The line of face with respect to cleats has to be carefully selected to get the best roof control. According to M. K. Guin (20, pg. 87);

"In the design of longwall faces, cleats play an important part. It has been found that satisfactory roof conditions are obtained when the face line is slightly off, being parallel to the main cleats. This gives a yielding face line throwing the front pressure away from the face, thereby avoiding cutting under the front pressure. With a face 'on end' the concentration of pressure along the coal edge causes breaks in the roof, and coal becomes very 'live' with loud rumbling noises during the whole cutting time. The undercut does not stand well, and falls of coal from the face onto the jib make undercutting extremely difficult... A yielding face line reduces the intensity of fracturing of the roof beds, and tends to keep it as an unbroken mass."

The conventional longwall system is applicable to seams of all pitches from level to about 1 in 2, or approximately 27-degrees. If the pitch is more, special methods are usually adopted. These are generally

modifications of the ordinary longwall methods.

In case of strip packing, the width of gate-side and intermediate packs and the width of wastes between packs, as also the optimum distance from the coal face to the packs, are to be determined by actual experience and, once determined, should be rigidly followed. The type of support system at the face depends upon the type of mechanization adopted at the face. The present day continuous mining operations employed in longwall face require the "prop-free-front" system of support which permits the shifting of face conveyor without dismantling as the face advances. The type of supports or the combination of different types of supports to be used, such as wooden props, rigid and yielding steel props, wooden and steel bars and wood and steel cribs depend upon the depth and thickness of seam and nature of coal, roof and floor. The selection of a correct type of support both at the face and at the gate roads is difficult and much depends upon the experience of the mining engineers on the job. This is true whether it is longwall advancing or longwall retreating system.

Longwall faces can be worked by handgot operation, by conventional mining equipment or by continuous miners. Handgot coal mining by picks is not very common these days but in Germany, pneumatic picks have been extensively used and produce a large percentage of the nation's output. This is a very desirable tool in areas where floor and roof

conditions are bad and would not permit any kind of cutting or blasting. Conventional mining would include cutting, drilling, blasting and loading, by shoveling or loading machines, whereas in a continuous mining system the coal is cut and loaded directly onto face conveyors by the continuous miner.

Opening-out of Longwall Faces

The method of opening out of longwall faces in advancing longwall system depends upon thickness and depth of the seam and the presence or absence of dirt bands. There are two methods which can be employed; viz., (i) by narrow workings, and (ii) by wide workings.

In opening-out by narrow workings, a narrow room of sufficient width, to allow of the installation of a conveyor or the laying of a tub track plus a width sufficient to allow a coal cutter to pass and make the first cut in the new face, is driven in a direction at right angles to the direction of advance of longwall face (Figure 61). This narrow room can be driven by shortwall or arcwall cutting machine in conjunction with a power loader or by a continuous miner. The coal from the narrow work can be conveyed either by a conveyor or by tubs. The conveyor or the track is extended as the face advances. The same conveyor or track is utilized for the longwall operation. Supports are set so as to facilitate the starting of the face.

Opening-out by wide workings is generally adopted in thin seams and seams containing dirt bands. The room is

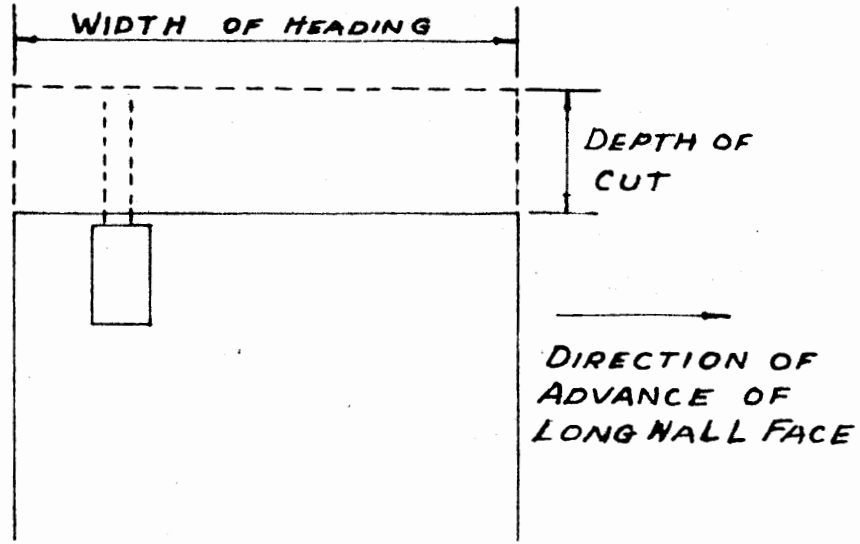

FIGURE 61

Method of opening a Longwall face (124)

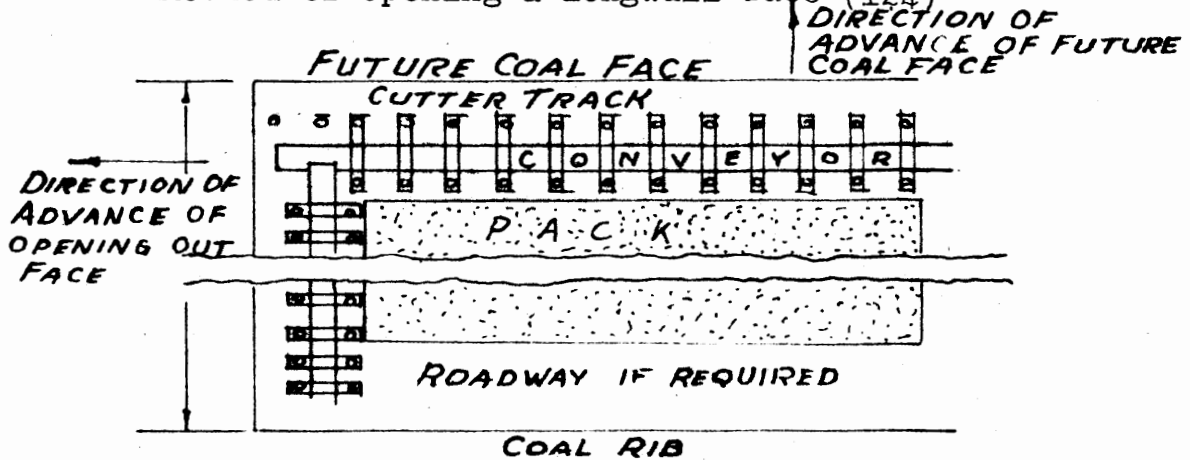

FIGURE 62

Method of opening a Longwall face by wide-work (124)

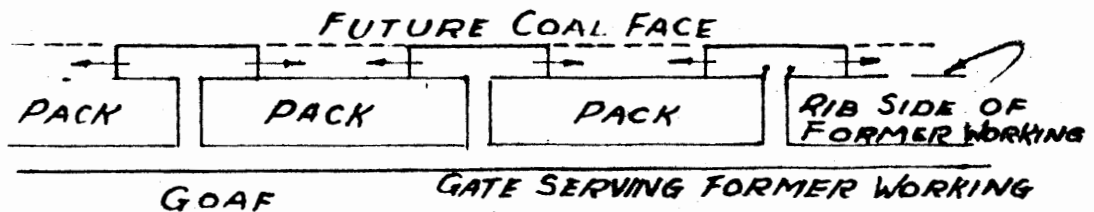

FIGURE 63

Method of opening a Longwall face on the rib-side of former workings (124)

made wide and the waste bands are used for packing as shown in Figure 62. The opening-up face advances to the left and the longwall face yet to be opened out is indicated by arrow. It can be seen that a cutter track is left along the future longwall face and the conveyor used for opening-up is subsequently employed as the coalface conveyor on the new face.

A method of opening-out a face from an existing roadway with a ribside pack is shown in Figure 63. A number of breakthroughs are made in the rib-side pack at appropriate intervals and narrow headings are driven in coal in the direction shown by arrows. When these narrow headings are coupled up they serve as the starting line for the new longwall face.

A sketch plan showing the method of forming coalfaces by cross-gate extension is shown in Figure 64. The development face BCD is served by conveyors which are indicated by arrows. When point E is reached, a cross-gate EF is packed out to the left from the loading gate ACE. When the cross-gate reaches the point F, a face FG, at right angles to EF, is formed and a conveyor installed which delivers coal to the cross-gate EF. When the developing face reaches the point H, another cross-gate HJ is formed. When the face FG, as it advances, reaches the cross-gate HJ at J, the conveyor is turned so that coal is transported to the new gate as shown by arrow. As the face further advances the right hand side of the cross-gate HJ is also developed until a double unit face LMN is formed which is

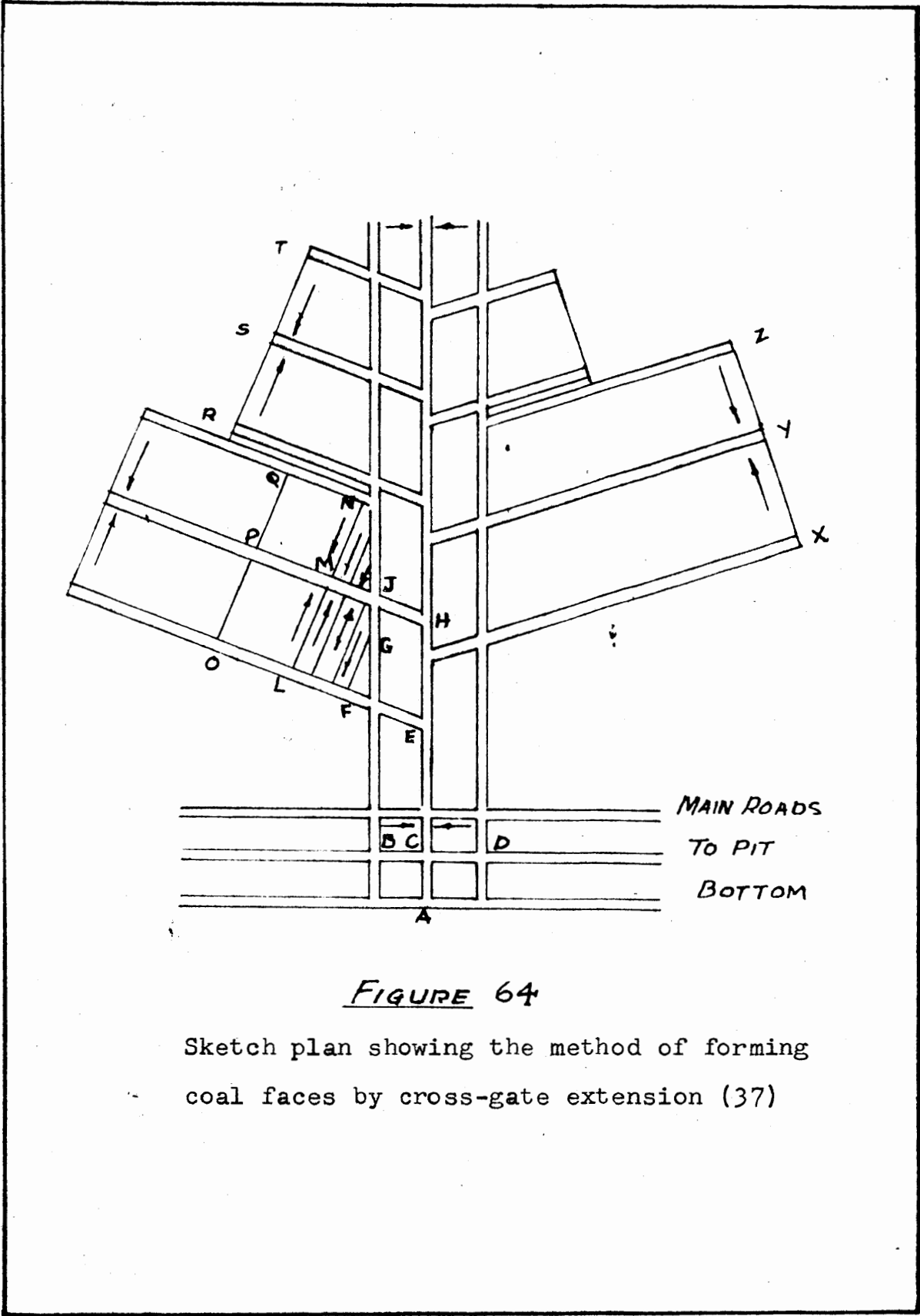

FIGURE 64

Sketch plan showing the method of forming coal faces by cross-gate extension (37)

advanced to the desired length. In the same way the other faces RST and XYZ are formed.

Handgot Longwall Faces

A typical handgot longwall system of mining is illustrated in Figure 65 where coal is cut by picks and shoveled into tubs at the face. Track is laid as near to the face as possible and parallel to it. Tubs can be replaced by conveyors at the face. The tubs loaded at the face are transferred at the roadheads or stall gates by either a flat iron sheet or by a turn table. In the stall gate near the face, a "passbye" is made for handling loaded and empty tubs. If conveyors are used, then the face conveyor will transfer the coal onto the gate conveyor.

In level seams the gate may be situated at the center of the length of face but when the pitch is pronounced the length of face along the rise side of the gate is more than that along the dip side to facilitate tramping. But nowadays in pitching beds, conveyors are invariably used at the face from the point of view of safety and efficiency and in such cases the gate road is situated at the center. In the plan view of Figure 65, the roof bars at the face are omitted for the sake of clearness, but the packs built in the goaf with their dimensions and the position of cribs are shown clearly. The props and bars have been shown in the section. Stall gates in seams $4\frac{1}{2}$ to 6 ft. in thickness may vary from 25 yd. to 80 yd. apart and the turnover is usually between 4 ft. and 6 ft.

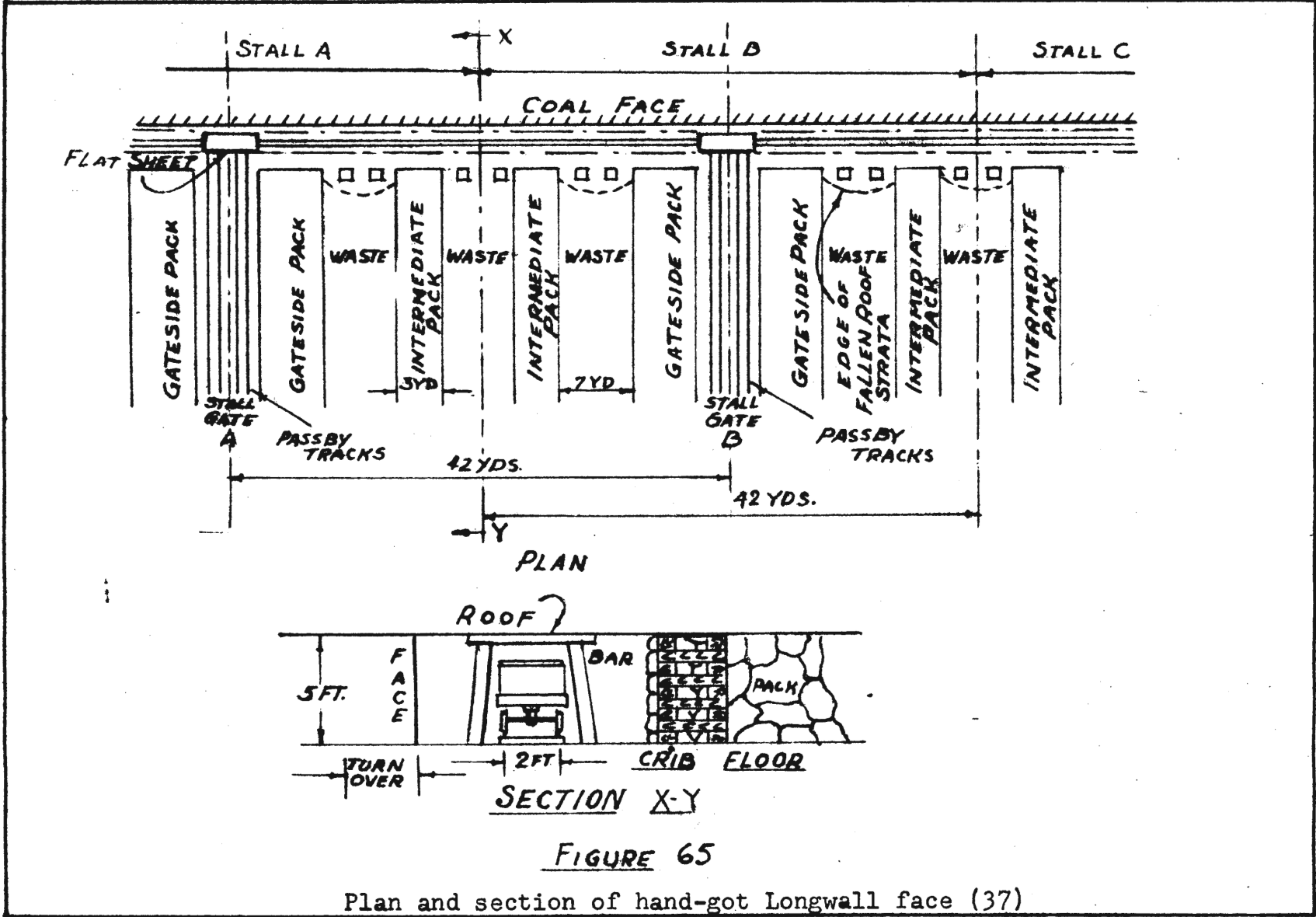

Stall gates are generally at right angles to the face. The use of cross-gates eliminates the need to maintain long lengths of gate roads and facilitates the transport of coal from the face and gates to the main haulage. Cross-gates are usually turned at an angle of 30° to 45° to the faces. Their distance apart is such that the maximum effective lift is obtained from the gates before they are cut off by the next cross gate and abandoned, and without the need for undue repairs; generally 80 yards is considered to be minimum and 150 yards as a maximum as shown in Figure 66.

The cycle of operations of handgot faces consists of; (a) undercutting coal and spragging, (b) filling of coal and setting of roof supports, (c) packing of face, ripping or brushing of roof and shifting of track or conveyor, as the case may be, towards the coal face, (d) withdrawal and resetting of cribs, where used, and (e) withdrawal of props, bars, etc. from the waste.

Mechanized Longwall Faces

The length of mechanized longwall face varies depending upon local conditions and practices in particular coal-fields and individual collieries. The factors that may influence the problem are: (a) thickness of seam which fixes the output of coal in tons per unit length of face for a given turnover or buttock, (b) the nature of roof and floor which determines the type, strength and number of roof supports required per unit length of face and the facilities for transporting these materials along the face,

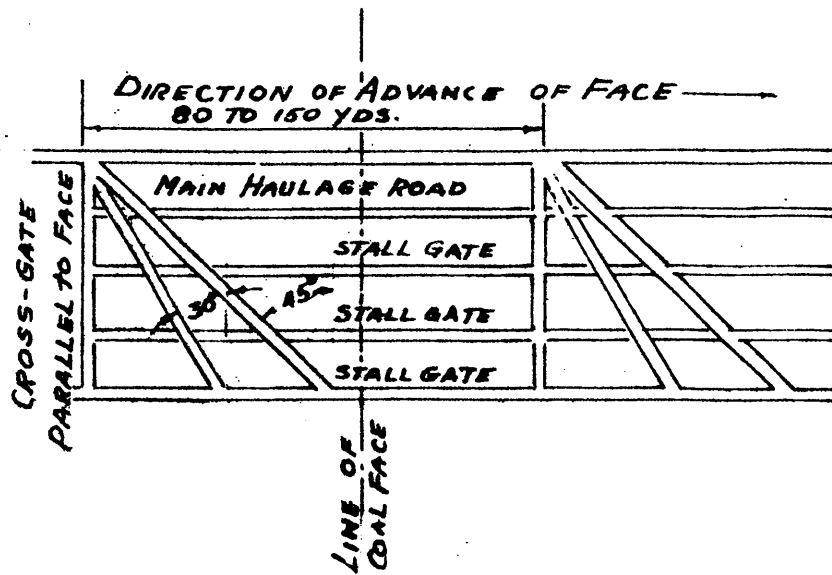

FIGURE 66

Plan showing varying angles of cross-gates (130)

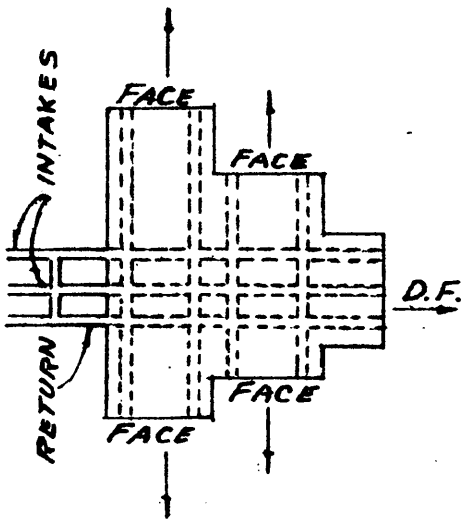

FIGURE 67

Layout of single unit faces (130)

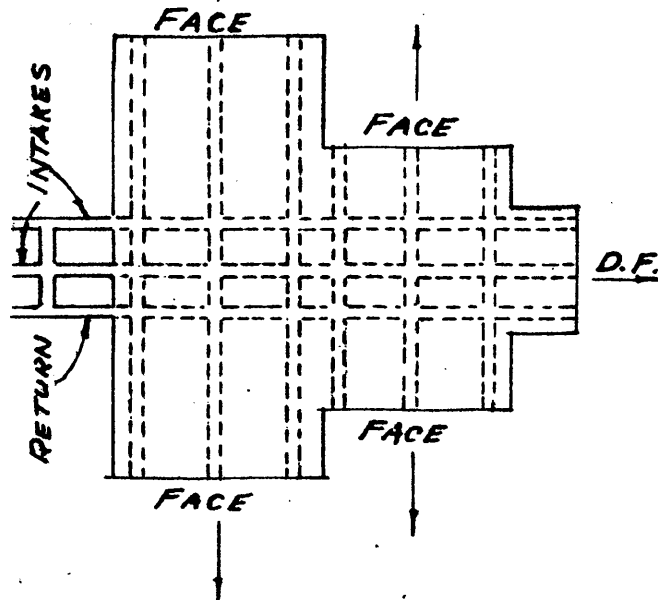

FIGURE 68

Layout of double unit faces (130)

(c) the pitch along the face, (d) the rate of gas emission per ton of coal from the face which determines the quantity of air required to render these gases harmless, (e) quantity of dust produced during mining operations, (f) the type of machinery used and (g) the degree of development of team spirit amongst various sections of workers.

In the United Kingdom, longwall faces vary in length from 50 to 500 yards but the usual is about 200 yards. In Germany, the face length depends upon the distance between horizons or distance between staple pits. In United States some of the faces are as long as 500 ft. and in India, the length varies between 200 and 300 ft.

The layout may be single or double unit. In single unit, the face has one conveyor delivering coal onto the gate conveyor which is on the intake. The gate at the other end of the face is then the return. Figure 67 shows a layout of four single unit faces having four production faces and one development face from which the production units are opened out as required.

In a double unit layout, there are two conveyors carrying coal in opposite directions and delivering it onto the main gate conveyor which is at or near the middle of the unit. This gate is the intake and the tail gate, at each end of the unit, forms the return. The layout of double unit faces is shown in Figure 68. This has four production units and one development unit.

Cross-gates may be constructed at intervals to reduce the length of hauling. This is shown in Figure 69 in which two double unit faces advance in one line. These cross-gates may be driven through goaf when the goaf has settled. Coal from the face to left of A is conveyed via the cross-gate to road B where it is joined by coal from the face between A and B in the single main haulage road B which, outbye of the cross-gates, serves for both the double unit faces.

A typical layout of an advancing longwall face for hand filling in a seam 3 ft. 6 in. thick, at a depth of 1869 ft., at the shaft, is shown in Figure 70a, b and c. The face, 100 yards long, is equipped with a bottom loading belt conveyor delivering coal, by a rib-side chain feeder conveyor, to a bottom loading gate conveyor. A normal longwall coal cutter and drilling equipment are provided at the face. The cut and shot coal is filled-off ahead of the coal cutter. As soon as sufficient coal is cleared, the coal cutter is jibbed-in and starts cutting along the face behind the face workers who clear the face. When all the coal has been cleared, the face conveyor is moved over to the new position and then packing and drawing-off operations are commenced. The main and conveyor-gate roads are made 12 ft. wide and 8 ft. high by brushing the floor. They are supported by 12 ft. by 6 X 5 in. joists on wooden props. The tail gate is brushed to a height of 6 ft. and a width of 6 ft. and is supported by 5 ft. 6 in.

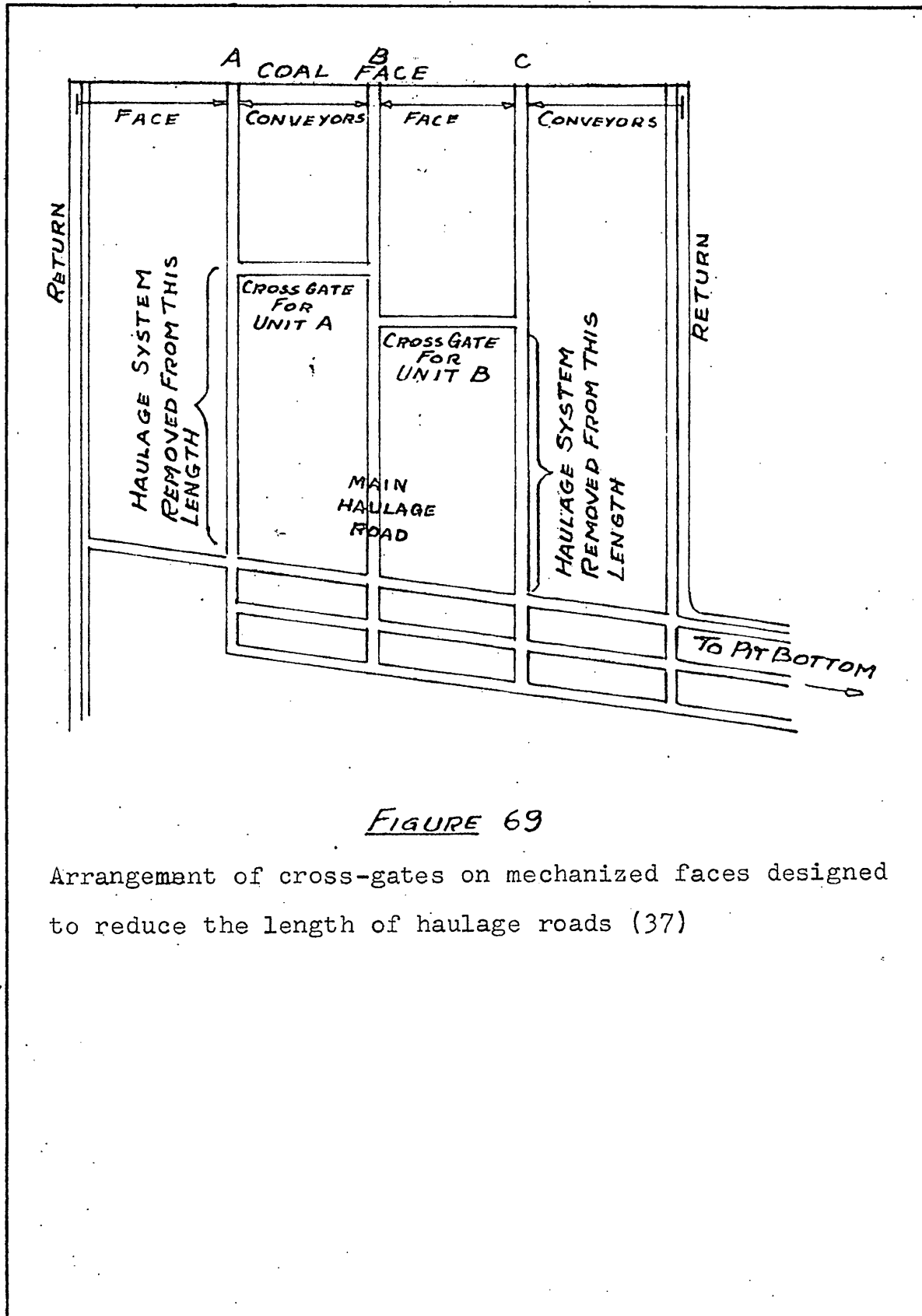

FIGURE 69

Arrangement of cross-gates on mechanized faces designed to reduce the length of haulage roads (37)

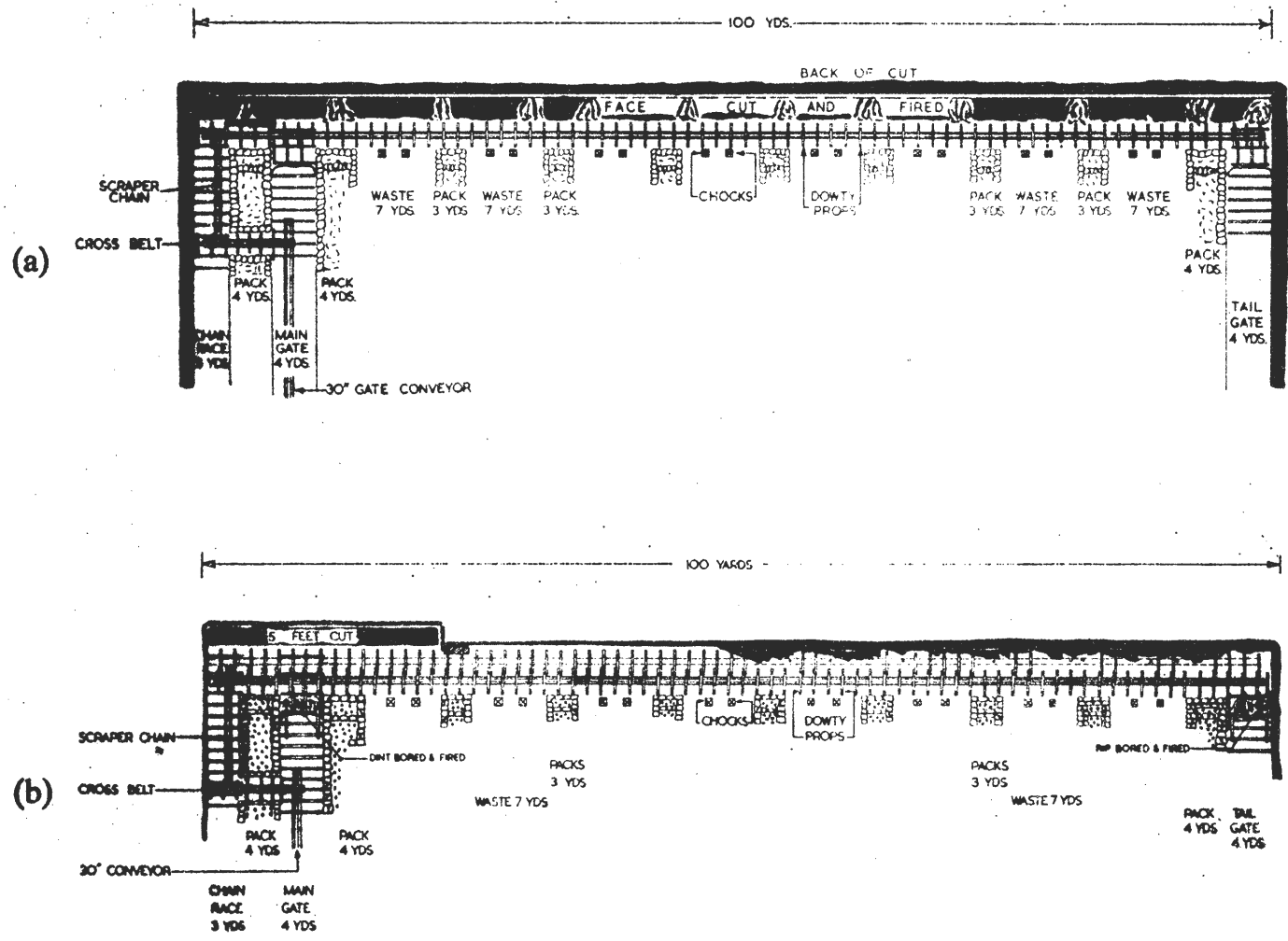

Figure 70

Layout of Longwall face by conventional method (32)

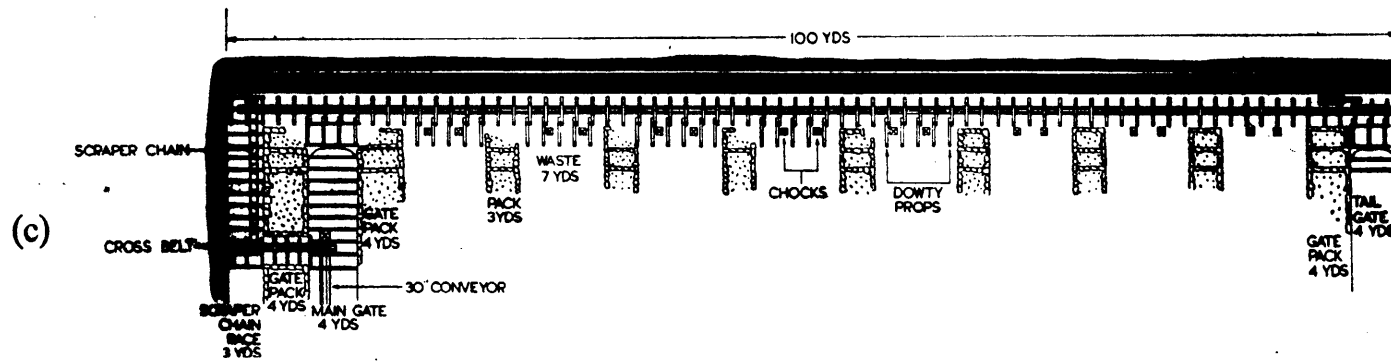

Figure 70

Layout of Longwall face by conventional method (32)

wooden props and 3 X 3-in. by 6 ft. girders. Hydraulic props and cribs or chocks are used at the face. Figure 70 shows hand filling operations in three phases: (a) before filling, face cut and fired; (b) face partly stripped, and (c) face filled-off. It takes one shift to complete one cycle by this method.

Figures 71a, b and c show the layout of a longwall continuous mining face under similar conditions as described in the preceding paragraph. The face, 100 yards long, is equipped with a bottom loading face conveyor with rib-side chain delivery to the gate conveyor, two shortwall coal cutters and two drills at the two gate-headings and a cutter-loader at the face. The face layout is the same as in Figure 70, but it is provided with a 10 ft. wide stable hole, at each end, maintained 7 ft. 6 in. ahead of the face. The stable holes are driven by shortwall coal cutters and the coal is hand filled onto the face conveyor. The face conveyor is laid within 18 inches of the solid coal (width of cutter-loader is 15 inches) and the cutter-loader passes along the face between the coal face and the conveyor; there being no intermediate face-side props to obstruct loading. Support of the roof is by cantilever bars whilst the machine is passing. Packing of the face proceeds as the cutter-loader has passed, so that, the face is completely packed and drawn-off when the machine arrives in the stable hole as shown in Figure 71c. The machine gives two cuts of 2 ft. 6 in. depth each shift.

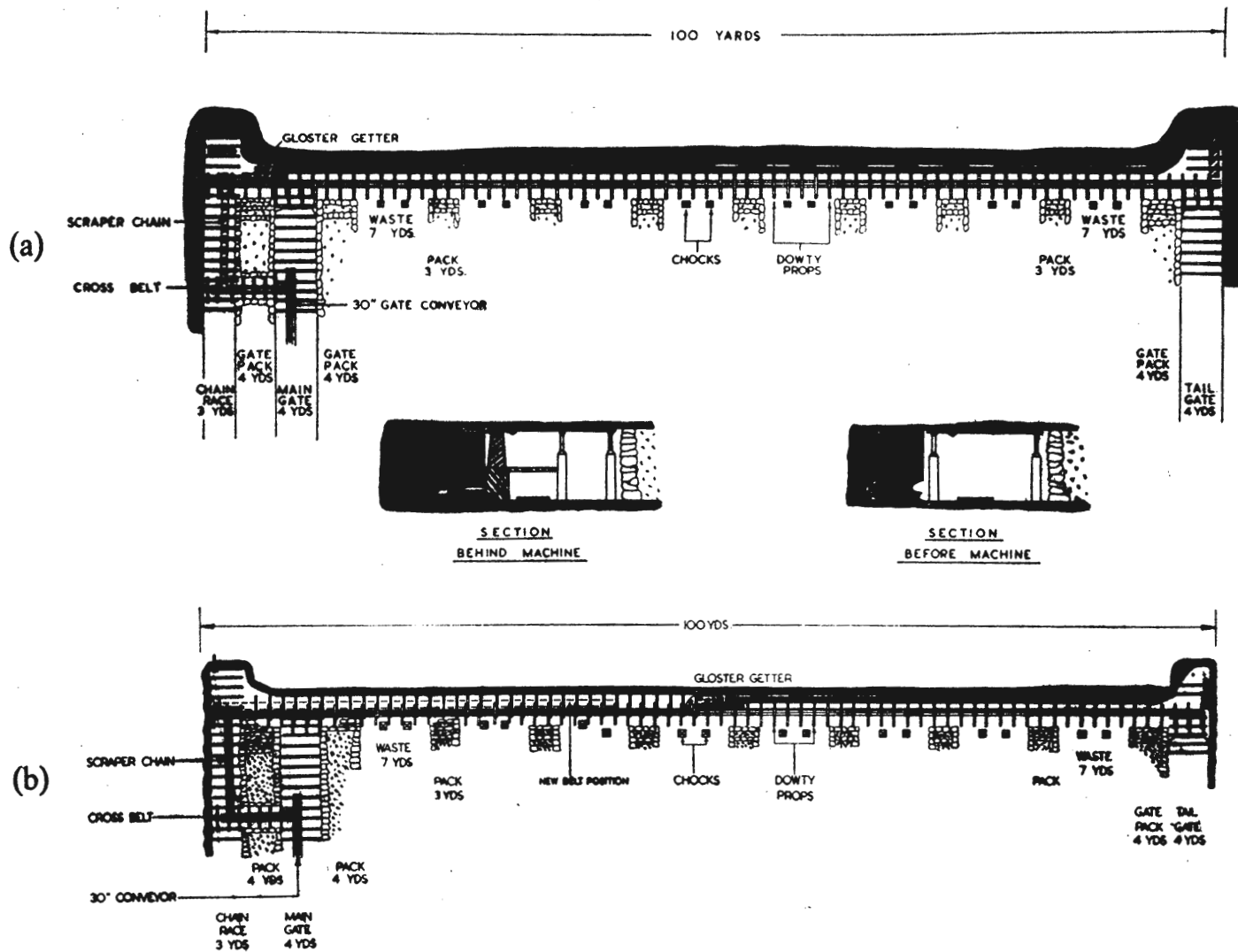

Figure 71

Layout of Longwall face by continuous method (32)

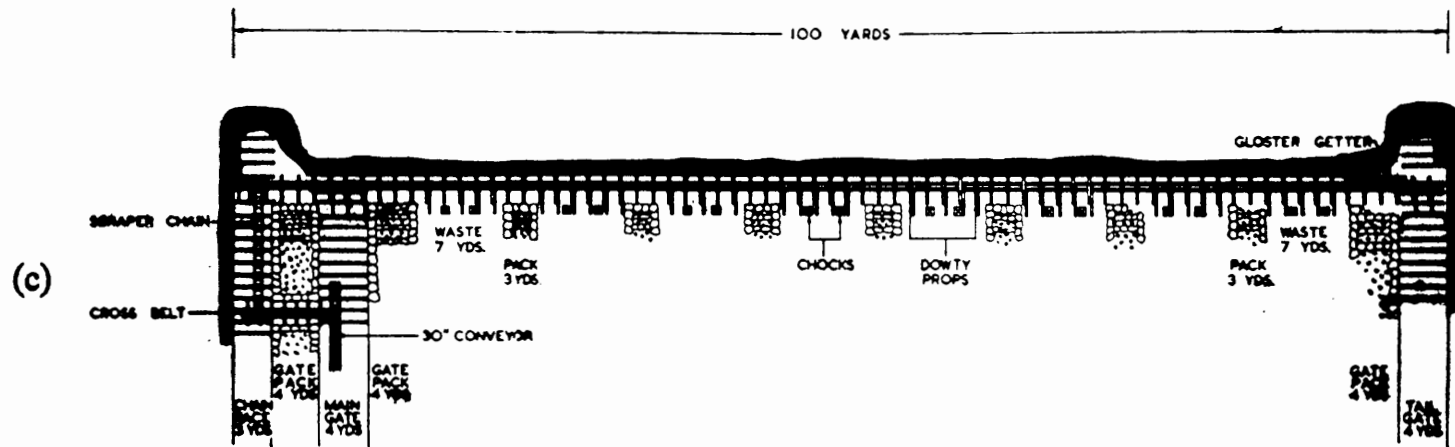

Figure 71

Layout of Longwall face by continuous method (32)

Figure 72 gives the general arrangement and method of support in a longwall face 178 yards long and using a panzer conveyor which can be "snaked". The cutter with a curved jib moves over the conveyor. The right-hand gate, containing a 30 in. troughed belt conveyor and a stage loader has already been headed in advance of the face by a Joy loader. This roadway, therefore, forms the right-hand stable hole. The left-hand stable hole is advanced with hand getting assisted by a shortwall coal cutter and short portable conveyor on wheels. The face supports consist of pivot jointed light alloy roof bars each with an effective length of 3 ft. 3½ in., supported by steel friction props and set with an initial resistance of approximately 6.5 tons. As the coal is cut, blasted and loaded, the snaking conveyor is shifted forward by rams. This system of layout has the advantage of adopting "prop-free-front" system so that no time is lost in shifting the conveyor.

A plan of the layout of longwall mining with a **Dosco** continuous miner is shown in Figure 73. The seam is 6 ft. thick, with a pitch of 14 percent and a depth of 2300 ft. The two main slopes and airways are driven down the dip with a 100 ft. barrier pillar between and a 400-foot barrier pillar left on either side of each airway. Four adjacent 500-foot longwall faces are driven simultaneously in the direction of the strike from each side of the main slopes. When these four faces reach the

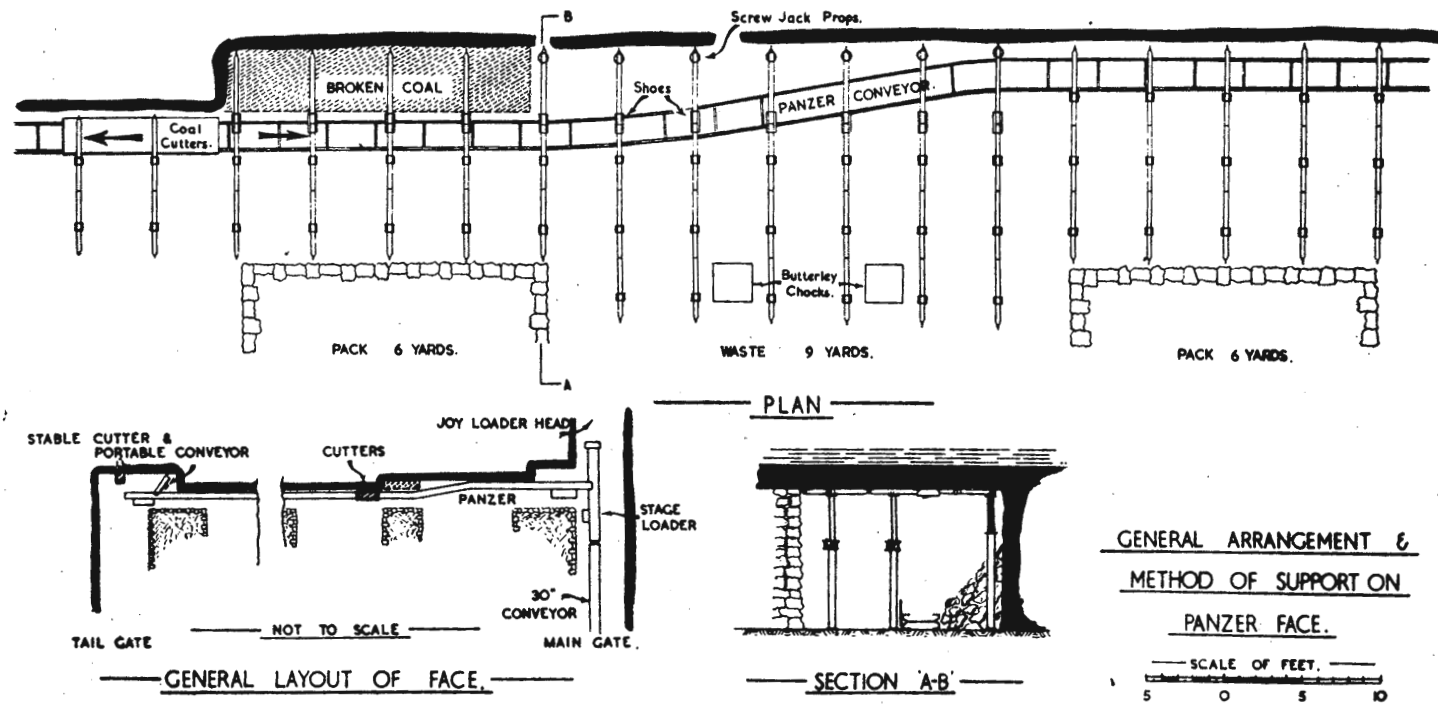

Figure 72

General arrangement and method of support on panzer face (26)

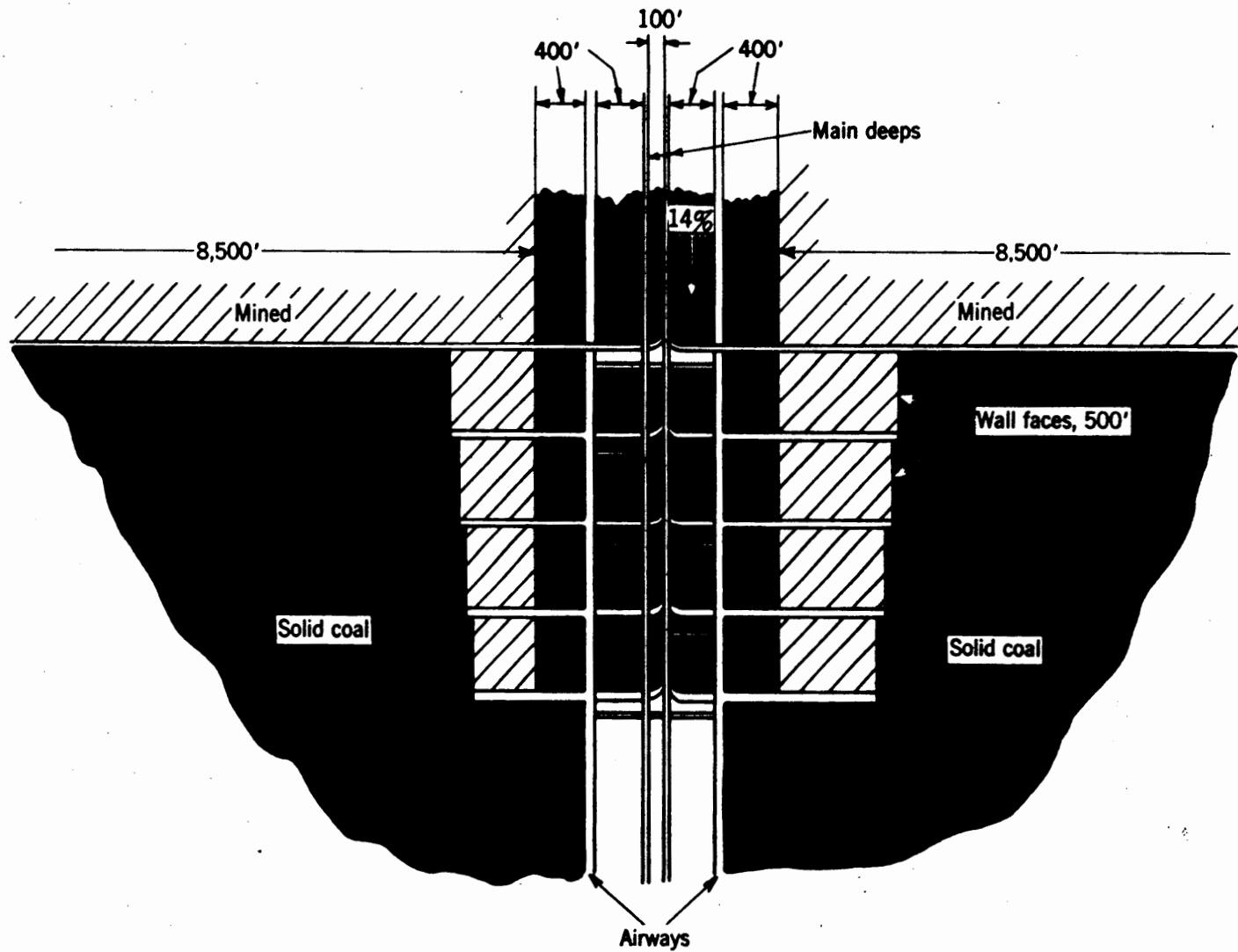

Figure 73

Mine plan using Dosco Continuous Miner (36)

predetermined boundary, the next deeper group is begun.

One crawler mounted continuous mining machine of the ripping head type is used on each 500-foot face. The continuous miner discharges the coal by its transverse belt onto the 30 in. face belt conveyor which transports it down the pitch to a track mounted belt conveyor in the haulage entry. This, in turn, discharges the coal into mine cars (Figure 74). The face is supported by wood props, bars, cribs and packwalls as shown. In the haulage roads, the roof supports are packwalls and steel arches lagged with timber.

At the beginning of a cycle of operation, the miner is in a stall at the top of the face. If it is a single unit face, the stall is prepared by an undercutting machine and its coal is hand-loaded onto face conveyor. Where a number of adjacent faces are working, if the upper face is kept 10 ft. in advance of the next lower face, the stall is made by the Dosco miner. The miner is operated down the dip. A short chain conveyor is moved into place when the miner approaches the lower end of the face to convey the coal, which is mined below, up to the mine-car loader. When one cycle of cutting and loading is finished, the miner is trammed up the face and placed in the prepared stall for the next production operation. Then the belt is moved five feet equal to the width of cut laterally to a new position 12 inches from the face.

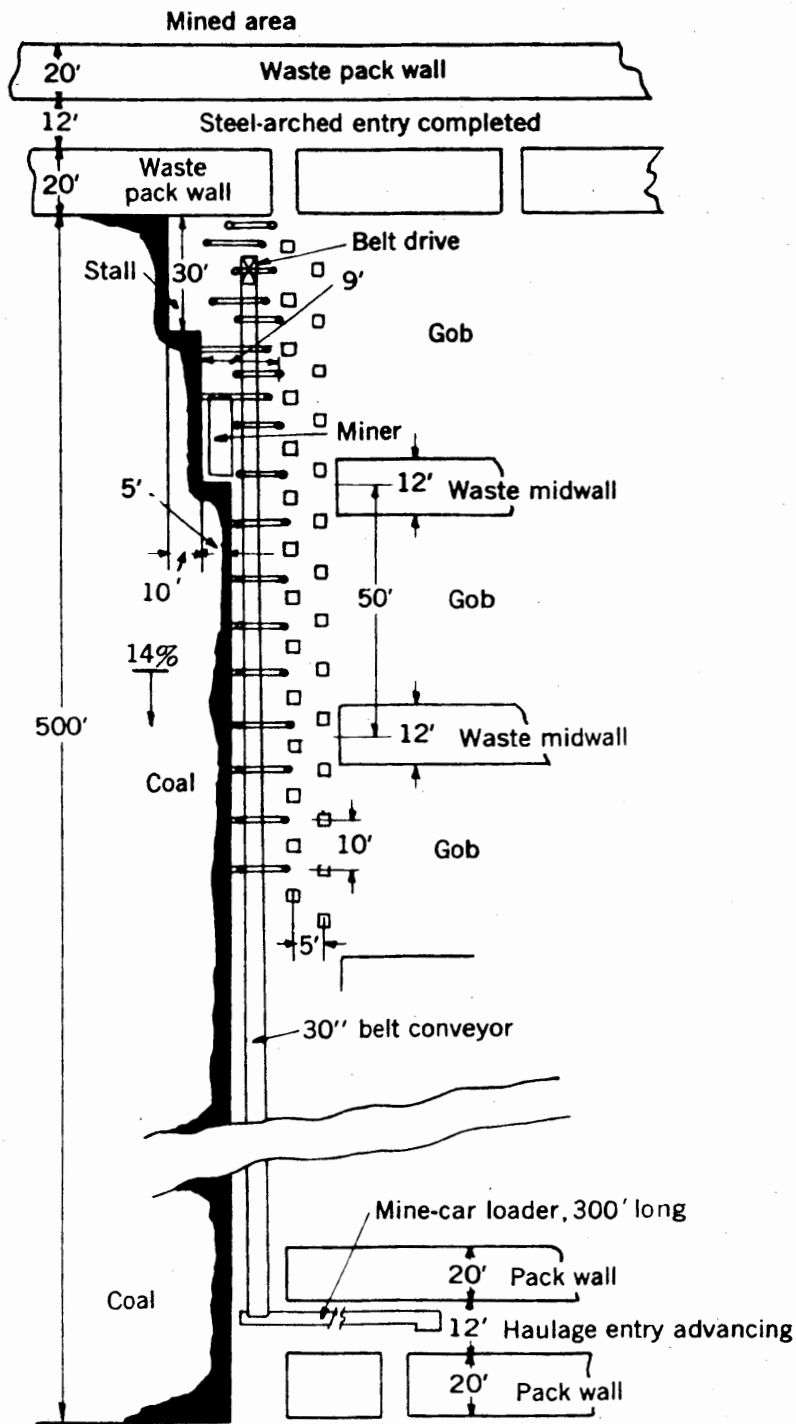
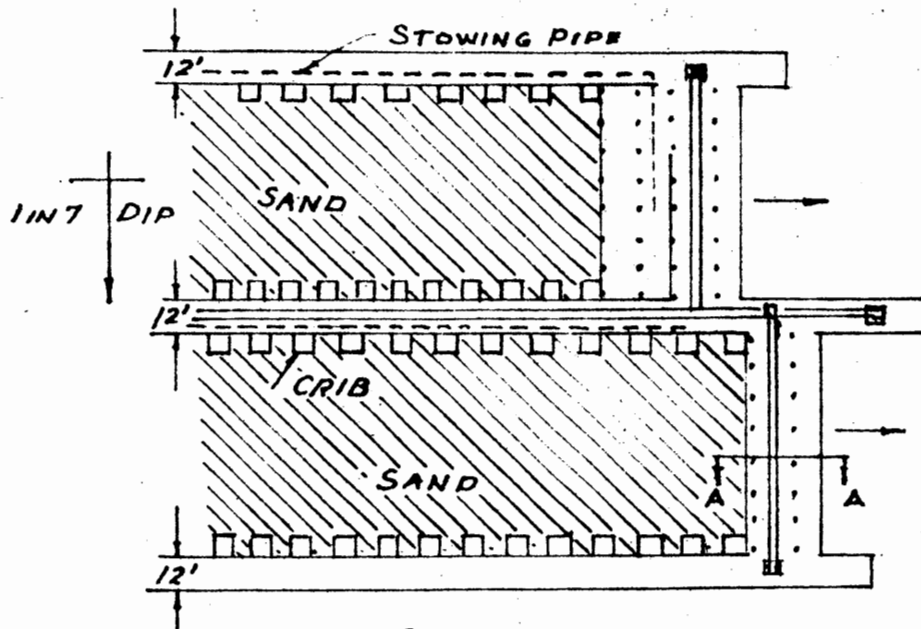

Figure 74

Layout of a 500 feet Longwall face with Dosco Miner (36)

The layout of a double-unit longwall face with complete packing by hydraulic stowing is shown in Figure 75. The center road is left entirely in goaf with sand packs and cribs on either side. All faces are kept slightly staggered to facilitate drainage of stowing water without affecting the dip face. The center gate accommodates the top-loading belt conveyor. The dip face is equipped with a bottom loading belt conveyor which conveys coal up hill to the gate belt and the rise face conveys coal through a shaker conveyor. The faces are worked alternately to secure steady production without stoppage during the stowing operation. The minimum distance between the pack and the coal face after stowing is 9 ft. and the maximum distance that can be exposed consistent with good roof control is 21 ft. When this limit is reached, 12 ft. of the goaf are hydraulically stowed solid with sand by erecting boxings which hold the sand. The coal is cut by a longwall coal cutter, drilled by electric drill, blasted and hand loaded onto the face conveyor. The main support is the sand pack. Face supports consist of wood props with lids. When face height tends to exceed 8 ft., wooden cribs are placed 12 ft. apart. All supports are recovered during stowing operations.

In steeply pitching seams (40° to vertical) the longwall faces are shorter than those in flat beds and the faces are advanced in steps. Caving is practically impossible in such beds. Although the longwall faces are



PLAN

FIGURE 75

Plan and section showing Advancing
 Longwall method with sandstowing
 (145)

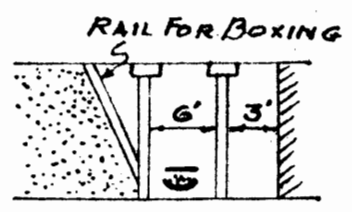

SECTION A A

advanced in the direction of the strike of the coal seams, those in steep seams are inclined at a suitable angle to regulate the rate of flow of coal. Generally, these faces are advanced as diagonals between the strike and the pitch so that the inclination of the face with the horizontal coincides with the angle of repose for the packing material. The lower end of the face leads the upper end and the entire face is advanced in a series of short steps. The width and depth of the steps are determined by such factors as the thickness of coal seam, the nature of the roof and floor, the rate of advance of the face, the proximity and rate of advance of adjacent faces and the amount of packing material available. When short steps are advanced in the direction of the strike, each workman is assigned to a given step of a face which he works throughout the life of the longwall face (Figure 76). On short steps of face worked in the direction of the inclination of the face, each miner in turn starts a step of a face at the top end and advances it until it is completed at the lower end. He then returns to the top end and starts a new face (Figure 77). Each miner is assigned a given rate of advance for his step of face per shift which is governed by the thickness of the seam, the nature of the coal, roof and floor and the pitch of the seam.

Face machinery includes only pneumatic picks. Men work over the back filling and coal is conveyed through chutes to the lower haulage-way. The upper and the lower

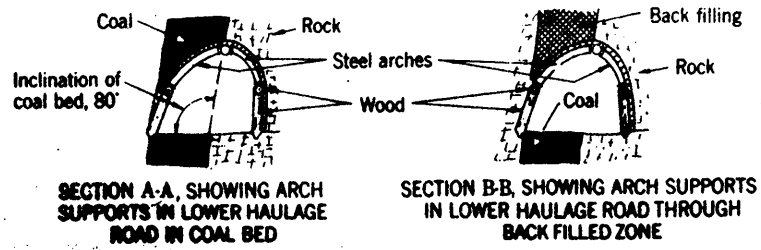
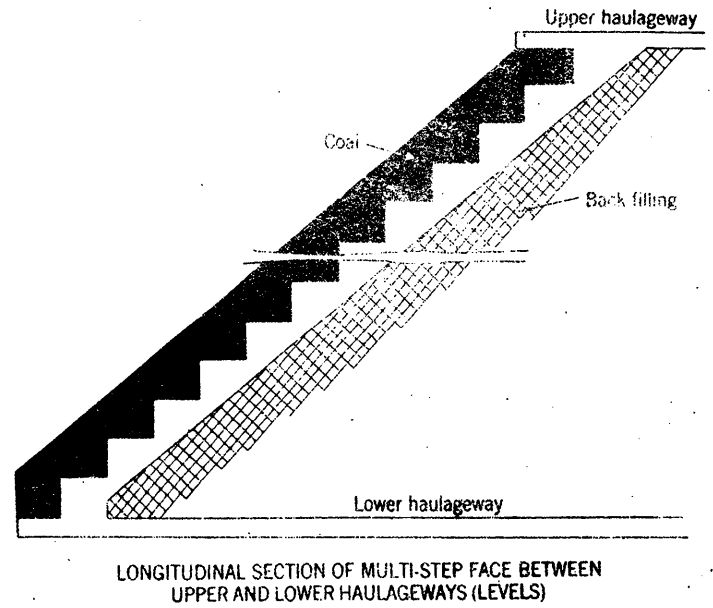
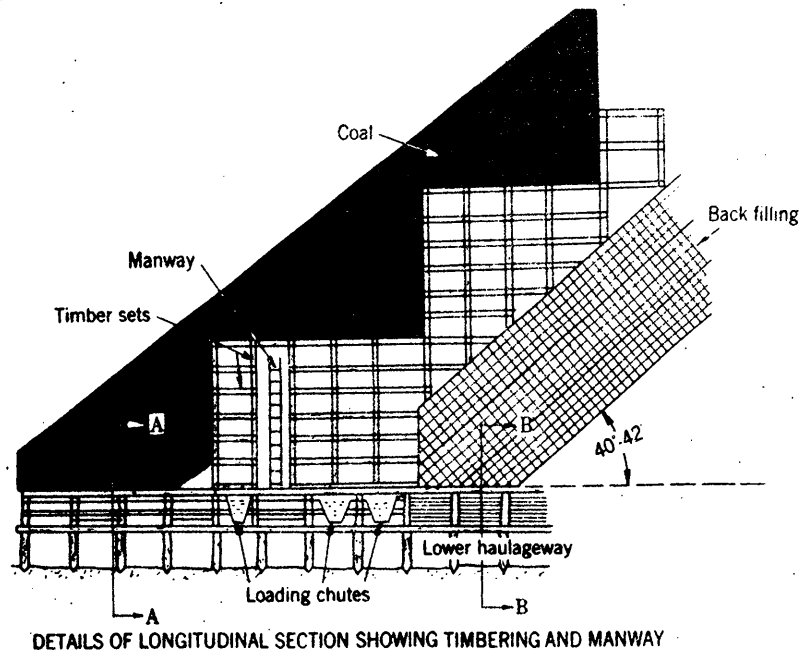

Figure 76

Longwall face in steep seams in Horizon system (5)

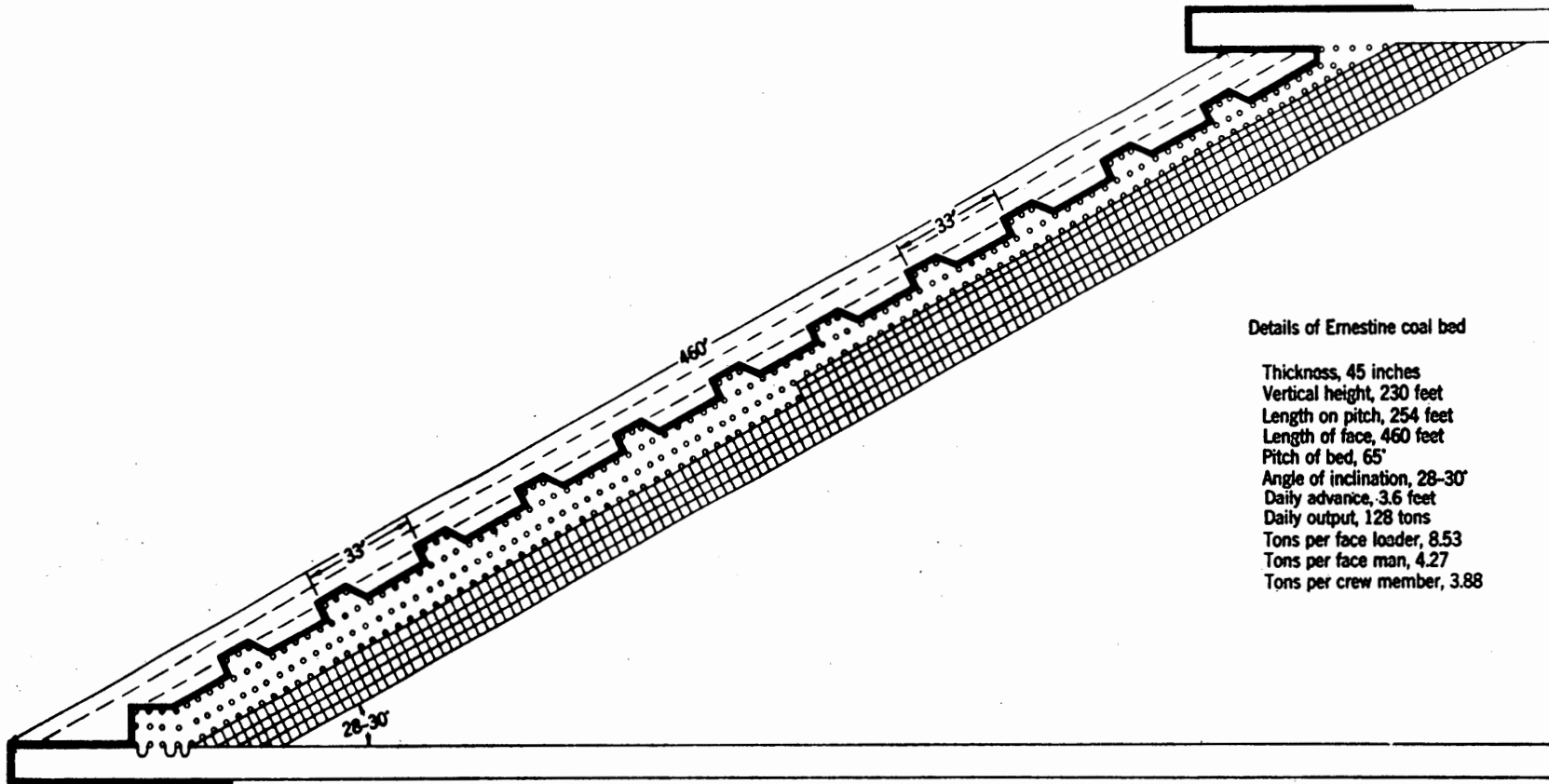

Figure 77

Plan and section showing Advancing Longwall method with sandstowing (5)

levels are arched and timber sets are erected at the face.

Longwall Retreating System

The main difference between longwall advancing and longwall retreating systems is that in the former case the coal from the winning out faces is transported through gate roads which are maintained in goaf, whereas, in the latter, it is transported through previously driven roadways in solid coal. The coal face retreats back towards the entries from which it was started and, thus, leaving behind the goaf. The principles of the longwall retreating system are shown in Figures 78 and 79 in which the method of opening out a face and the face being retreated towards the main entries are depicted. Pairs of headings, connected at intervals by cross-cuts are driven to a predetermined boundary; the distance between the pairs of headings form the length of retreating face. When these pairs of headings reach the boundary, they are connected as shown. With the connection made, the face is opened up and retreated back as shown in Figure 79.

The same type of face machinery and equipment may be used here as in the longwall advancing system. The method of support at the face will also be the same and depending upon roof and floor conditions, but the packs need not be built except in special cases in order to eliminate or reduce the effect of subsidence at the surface.

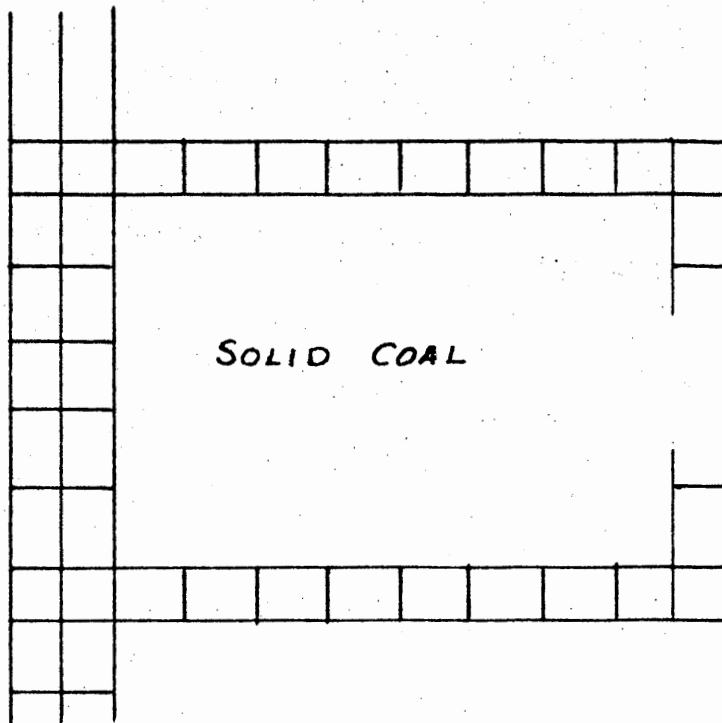

FIGURE 78

Opening out a panel for Longwall Retreating system (37)

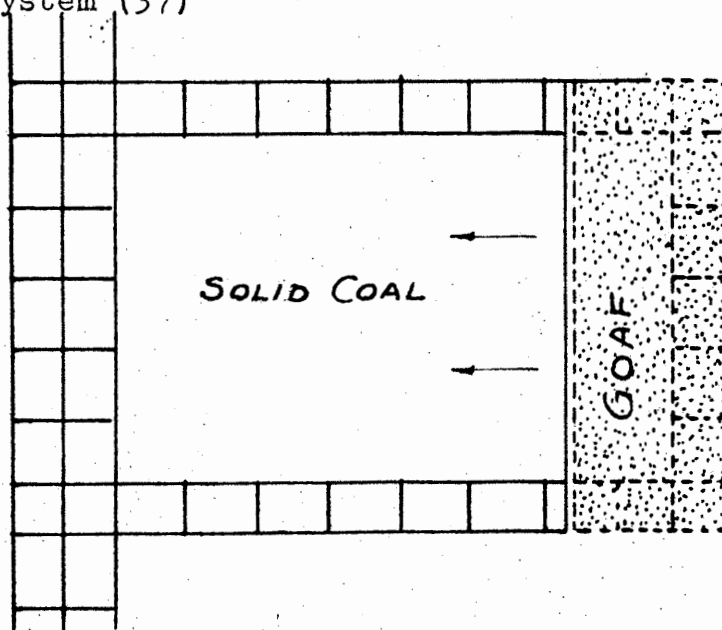

FIGURE 79

Retreating Longwall face (37)

Much of the success of this system depends upon the distance to which the requisite number of headings are to be driven in the solid coal before the retreating faces are opened out and also upon the effect of the natural phenomena upon these roads. The boundary, which may be either that of the mine or an arbitrary one, must be chosen wisely.

Figure 80 shows the layout of a panel for a retreating longwall system in a seam which is about 3 ft. thick. Two parallel sets of three entries with break-throughs at intervals are driven to the boundary. The entries are connected by two parallel rooms at the inbye end. Hand-load conveyors are used for this work. Each succeeding adjacent panel could be developed with only three entries and the parallel connecting rooms at the inbye end. The length of face is 328 ft. and the outbye 290 ft. of solid coal is left as a main entry barrier pillar which protects the main entries. The haulage gate for the face is made 21 ft. wide and 11 ft. of the width of this entry along the chain pillar rib is brushed in the floor to provide headroom. A belt conveyor is installed in the brushed part of the entry about 4 ft. from the chain-pillar rib. All other entries are driven 18 ft. wide and are not brushed.

The face equipment consists of an armoured double-chain conveyor, a coal planer or coal plough and 17 pneumatic shifters to move the conveyor as the face advances. The conveyor can be flexed in either direction as much as 5-degrees

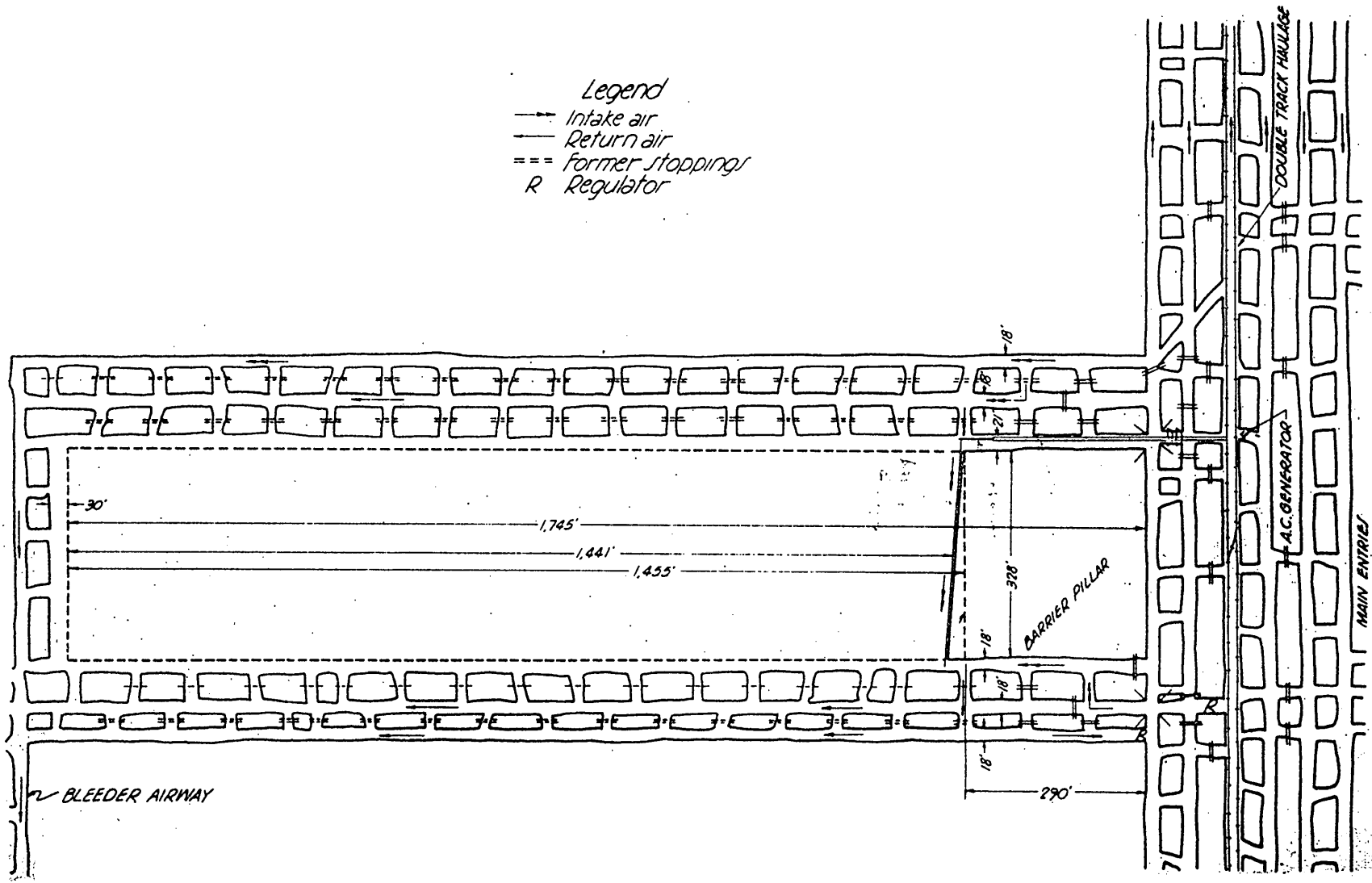

Figure 80

Layout of a Longwall panel using a Coal Planer (22)

from a straight line. A section of steel tube is attached to the face side of each conveyor pan. This tube is used as a return duct for the planer towing chain and as a guide for the planer.

The coal planer unit is a continuous mining machine that mines coal from a solid face and loads the mined coal with a ploughing action onto the face conveyor. The coal face is retreated at least 3 inches each time the planer moves in either direction along the face. Roof supports consist of wood cribs and steel jacks. A detailed plan of the planer face is shown in Figure 81.

Horizon Mining System

The layout of the coal faces in horizon mining refers to their length, direction of advance, distribution within the district and their relationship to the colliery as a whole. All the roadways for opening up the faces are driven in the seams and their layout depends upon the method of working to be adopted; whether it be advancing longwall or retreating longwall or face advancing to the rise or to the dip in flat, semi-steep or steep measures.

Face Development in Flat Measures

The most common practice is to have the faces advancing along the strike with two level gate roads, b, Figure 82, driven in the seam. The face length corresponds to the distance between the gate roads. The figure shows three seams with the upper seam being worked. Coal is transported through the staple pit to the lower cross-measure drift a.

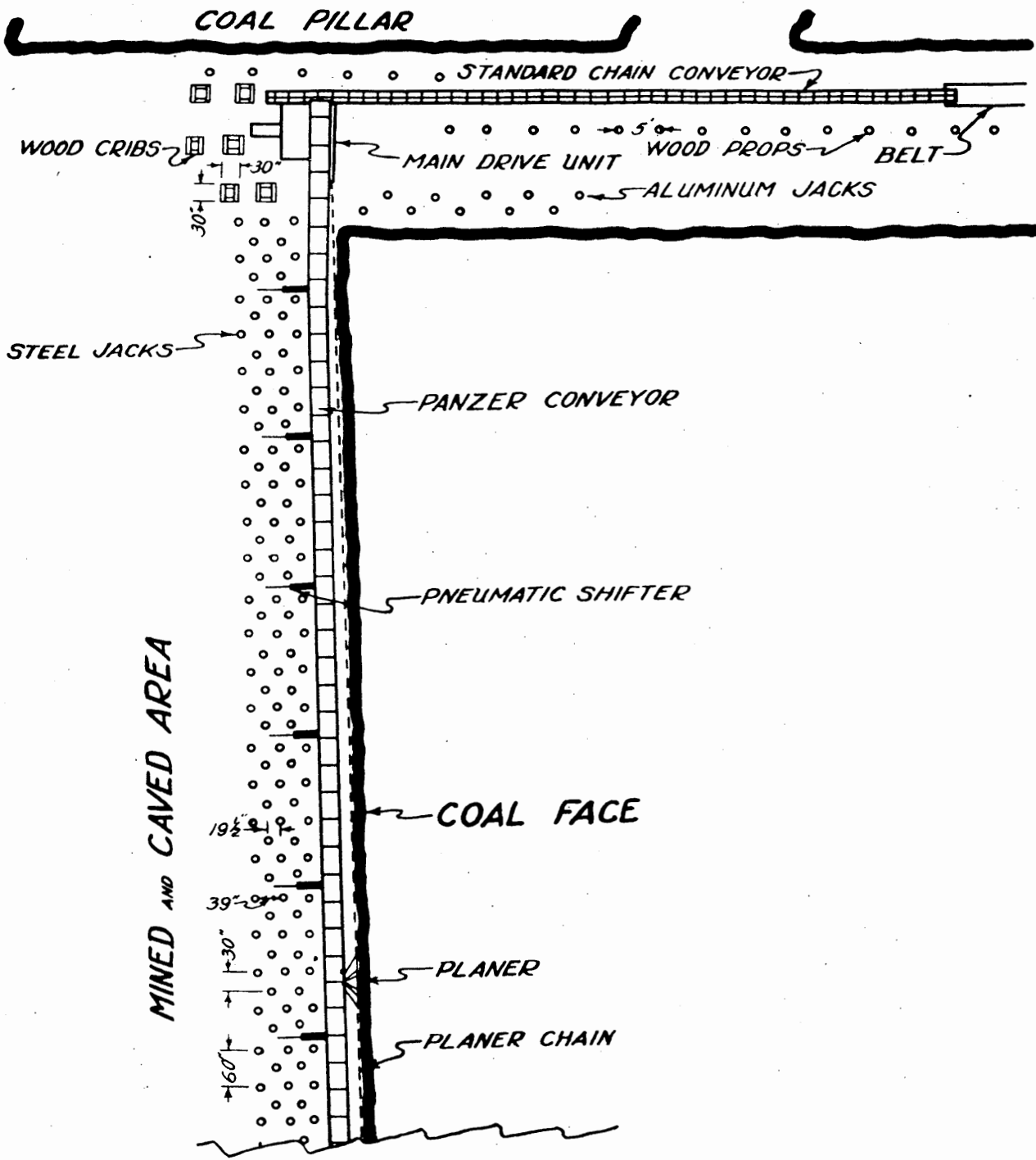

Figure 81

Layout of a face using Coal Planer (22)

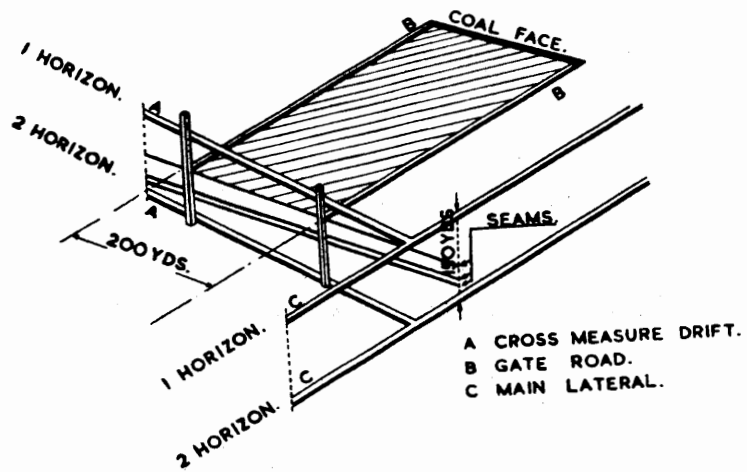

Figure 82

Coalface development in flat measures (11)

The gate roads are driven from the respective staple shafts. To open up the faces, the gate roads are driven about 30 ft. on either or both sides of the staple shaft and the face is prepared by connecting the gate roads from either, or both, the rise and dip side gate roads. When the connection is made, the face is equipped with a conveyor and other face machinery. The gate roads are developed as the face advances. If desired, both faces, advancing in opposite directions, may be worked at the same time; using either full caving, strip packing or solid stowing. If a single face is worked and followed by the second face in the other direction, the holing is maintained until the second face is due to start. With retreating longwall, the gate roads are driven to the required limit, then the holing is made and the same method of working the face is adopted. The main disadvantage of the retreating longwall system is the delay involved before the extraction starts and the necessity to transport the gateway rippings out-by, whereas, in most cases of advancing longwall, it can be used for packing immediately in the waste. Because of these difficulties, the advancing longwall system is practically universally adopted in the horizon system of mining. Faces, to the rise or to the dip, may also be worked by either the advancing or the retreating system; the face development under these conditions being completely different. A typical development to the rise is shown in Figure 83. The lower gate is first driven to the full extent and the

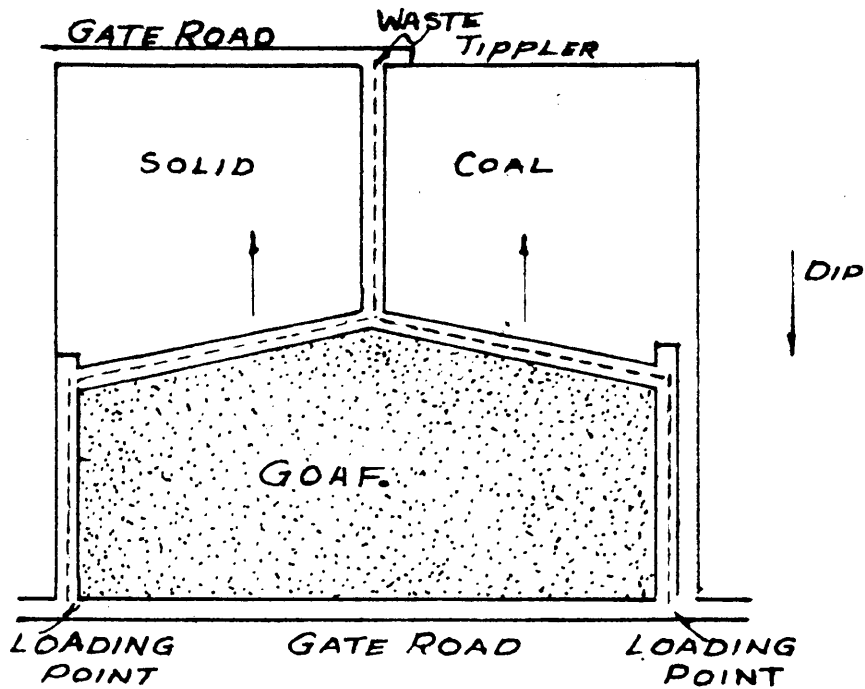

FIGURE 83

Layout of Longwall faces to the rise (11)

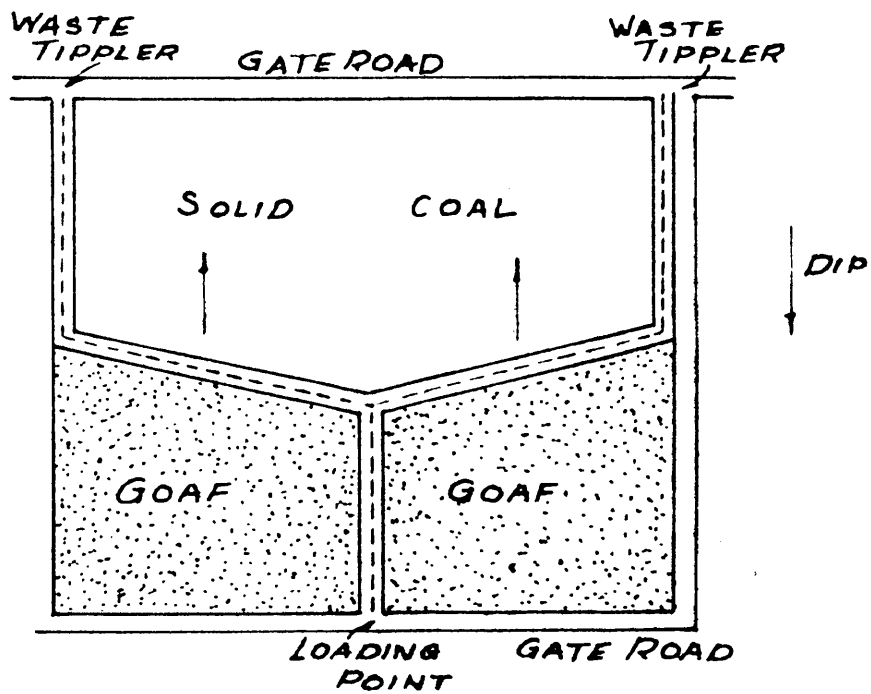

FIGURE 84

Layout of Longwall faces to the rise (11)

and the upper gate road midway along the striking length to be worked. A rise is then driven in the seam from the middle of the lower gate road to connect with the end of the upper gate road. This rise serves for return ventilation from the faces and also for transport of stowage material and supplies to the faces which advance to the rise as a double unit.

Another method of working towards the rise is shown in Figure 84. The two gate roads are driven to the full extent first and then they are connected by two rises at each end. These two rises serve for ventilation and transport of material. The face is opened between the rises which act as tail-gates to the double unit face.

In comparing these two methods, it can be seen that in the former case there are two loading points, one at each end of the panel and one central tipping point for the stowage material and supply, whereas, in the latter case, there are two waste tipping points, one at each end of the panel and one central loading point. In both cases, the loading and the tipping points are fixed for the life of the panel, whereas, the longwall system advancing to the strike, these points are advanced daily with the faces. This is a great advantage for working to the rise compared to working along the strike.

There is yet another system of development to the rise which may be convenient for the development of short longwall faces as shown in Figure 85. A gate to the strike is driven

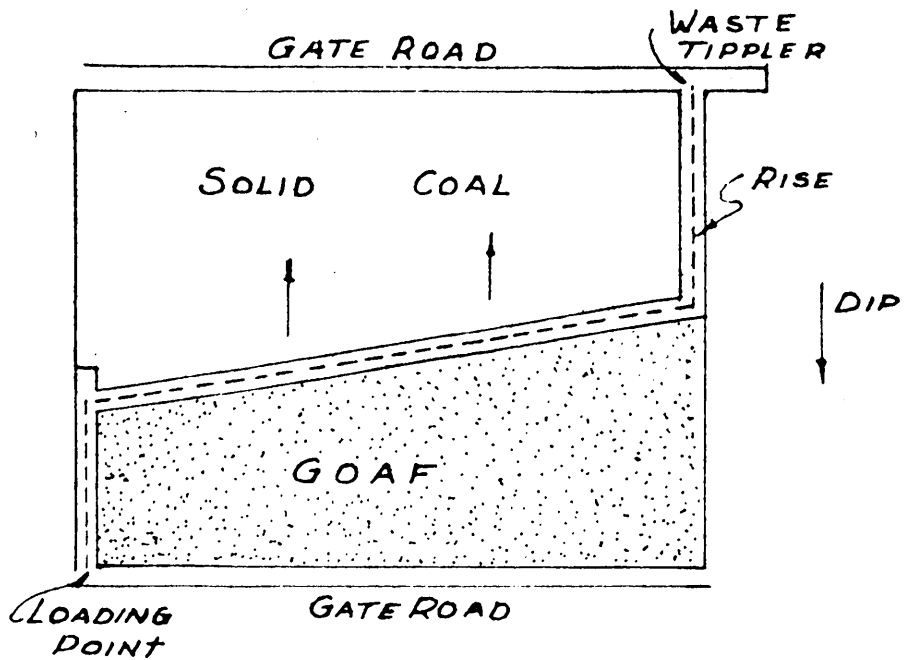

FIGURE 85

Layout of Longwall faces to the rise (11)

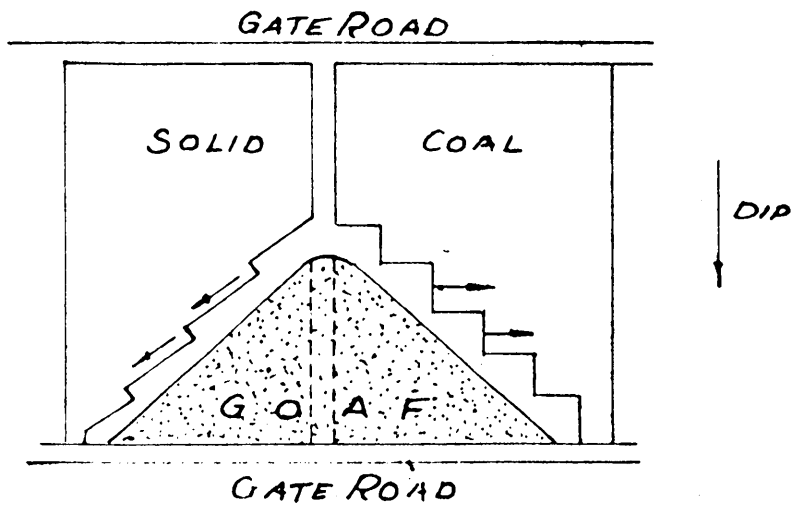

FIGURE 86

"Saw blade" and "Stepped" type Longwall faces in steep seam (11)

the entire length of the panel. A rise connecting the upper and the lower levels is driven at the extreme end of the panel and then a face is developed to the rise from the striking gate road as shown.

In developing faces to the dip, similar methods can be adopted. In working to the dip or to the rise, consideration must be given to the limits of conveying on the face and in the gates.

Face Development in Semi-steep and Steep Measures

The development of faces in semi-steep and steep measures is identical with the methods employed in flat measures except that the development to the rise or to the dip is not to be recommended. In such cases, development along the strike is most common.

In steep measures, the face is worked on a diagonal face line with the lower end of the face leading. The face line can be either a "stepped" or "saw-blade" type as shown in Figure 85. Faces of this type have already been shown in detail in Figures 76 and 77.

Sequence of Extraction in Flat Measures

In horizon mining, a district is limited in depth between the district cross-measure drift, on the main haulage level, and the corresponding cross-measure drift in the return airway level, and in the lateral direction by the staple shafts connecting the horizons. Within this limit, the faces developed represent a single production unit which is also a separate split for ventilation.

It is the normal practice to work the top seams first and extraction progresses to the lower horizons in sequence. Figure 87 shows a cross-section through a district which contains three seams. The length of coal face is chosen first as the number of staple shafts and their distance apart depends upon the length of coal face chosen. Full caving may be adopted. The first pair of faces are developed in the upper seam and worked in both directions to the strike as single unit faces between staple shafts 1 and 2. When these faces are being worked, another pair of faces between shafts 2 and 3 will be opened up in the same seam and the working of pairs of faces is continued in sequence between shafts 3 and 4 and between shafts 4 and 5. The middle and the lower seams are worked in sequence in the same manner; working being confined to only one seam at a time. This sequence of extraction implies that all the staple shafts of the district are provided in advance of extraction of the lower seams. These shafts must be fully equipped, but only one shaft is in use for winding coal and one for return air and supplies at any period of working. The output from this system of development is obtained from only one pair of diverging single unit faces. If only one single unit is worked at a time, only half the output would be obtained and the life of the district would also be double.

The disadvantage of forward staple shaft development can be overcome in several ways as shown in Figures 88, 89,

	5	4	3	2	1
1	4	3	2	1	
2	8	7	6	5	
3	12	11	10	9	

FIGURE 87

Different methods of sequence of extracting of three coal seams between two horizons (11)₂

	5	4	3	2	1
1	4	4	1	1	
2	5	5	2	2	
3	6	6	3	3	

FIGURE 88

Different methods of sequence of extracting of three coal seams between two horizons (11)

	5	4	3	2	1
1	2	2	1	1	
2	4	4	3	3	
3	6	6	5	5	

FIGURE 89

Different methods of sequence of extracting of three coal seams between two horizons (11)

	5	4	3	2	1
1	10	7	4	1	
2	11	8	5	2	
3	12	9	6	3	

FIGURE 90

Different methods of sequence of extracting of three coal seams between two horizons (11)

90 and 91, in which the sequence of working the individual seams between staple shaft positions is illustrated.

In the first method, shown in Figure 88, double unit faces in each seam are worked in descending order between staple shafts 1, 2 and 3 and so on to 3, 4 and 5. The double unit faces may be worked either singly or as diverging faces on each side of the staple shafts or cross-measure drift. The life of the district, if diverging double unit faces are worked, will be half that when simply one double unit face is employed at a time. In this case, sinking of staple shafts 4 and 5 can be delayed until they are finally required. With the double unit system of development there is also a higher efficiency in the concentration of output to the loading points at staple shafts 2 and 4. The staple shaft 2 serves as intake and the return air from working faces travels up the upper parts of shafts 1 and 3 to the return airway horizon. The same system is repeated between shafts 3, 4 and 5.

The sequence of extraction of the faces can also be as shown in Figure 89. This is similar to that shown in Figure 87 except that double unit faces are worked instead of single. Comparing the sequence of extraction shown in Figures 88 and 89, consideration of surface subsidence may influence the decision to work in either case. Where gradual subsidence over a large area is considered better in the circumstances, the system shown in Figure 89 would be an advantage.

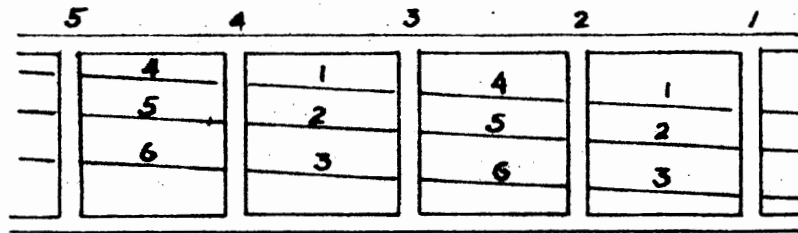

FIGURE 91

Sequence of extraction of three seams between two horizons
(11)

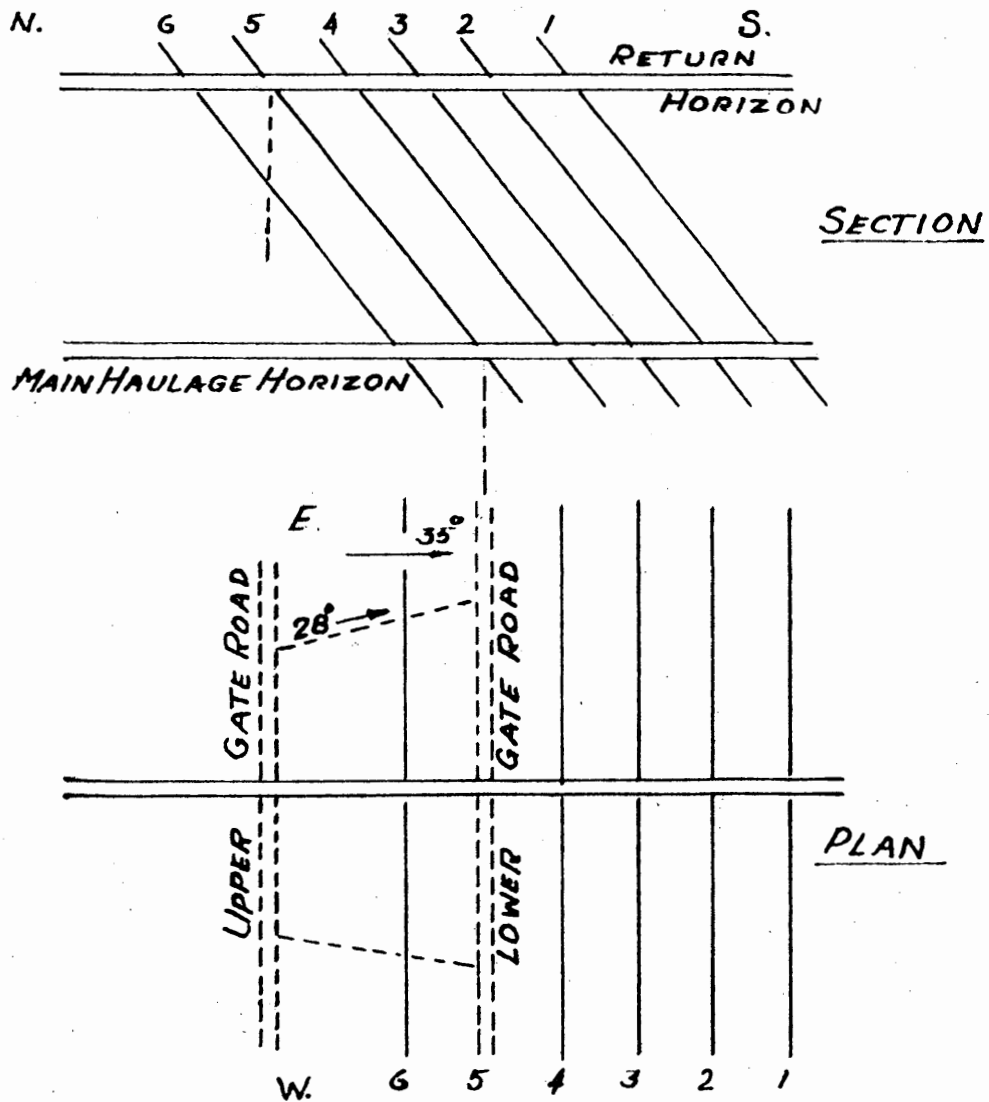

FIGURE 92 Layout of working faces
in semi-steep measures between two horizons (11)

If a concentration of output from the three seams to one loading point is required, the sequence of operation shown in Figure 90 may be employed. By this method, each staple shaft is used to its full capacity. This system has the disadvantage of high concentration of work within a comparatively small area, with possible major repercussions at the surface.

The sequence of extraction in Figure 91 shows a method of single unit development whereby the output can be raised to the same level as with double unit faces. This is done by staggering simultaneous, single unit development between staple shafts 1 and 2 and shafts 3 and 4 and working the three seams in sequence as shown in the figure. The ventilation system is the same as for normal single unit working. The disadvantages of this system from the point of view of surface damage is the same as in the case shown in Figure 90. Subsidence can be minimized if the sequence of working is organized to take place in each seam in turn between staple shafts 1 and 2 and between shafts 3 and 4, followed by working between 2 and 3 and between 4 and 5, always in the same seam.

Sequence of Extraction in Semi-steep and Steep Measures

The layout of faces in semi-steep seams is quite different from that in flat seams. The coal faces developed, extend from the main haulage horizon to the return airway horizon, if possible, and staple shafts are therefore avoided or reduced to one per district. If there is no haulage

installation in the return airway horizon, one staple shaft is advisable for the transport of men, machinery and stowage material. In this case, the materials and supplies are transported through the main haulage horizon to the staple shaft and then hoisted through the shaft to the working places.

Figure 92 shows a district where the seams are pitching at 35° . The face is so arranged that the angle of dip on the face is 28° . Thus, the faces have a diagonal layout. Each face is equipped with retarding disc conveyors. Generally diverging faces on the strike are worked simultaneously in each seam in descending order.

In steep seams where the pitch exceeds 40° , it is not always possible to develop faces extending between horizons. The length of faces in that case may be too great or the horizontal interval severely restricted. The vertical interval between the horizons must therefore be sub-divided into 2, 3 or 4 sections, each 60 to 90 yards in depth and separated by sub-levels. Each of these sections will incorporate two faces laid out diagonally and between 100 and 200 yards long according to the pitch of the seams.

There are three different methods of working these vertical sections in steeply pitching seams as shown in Figures 93, 94 and 95.

The first method is illustrated in Figure 93. The sections between the upper and the lower horizons are worked in ascending order, each section consisting of two diverging

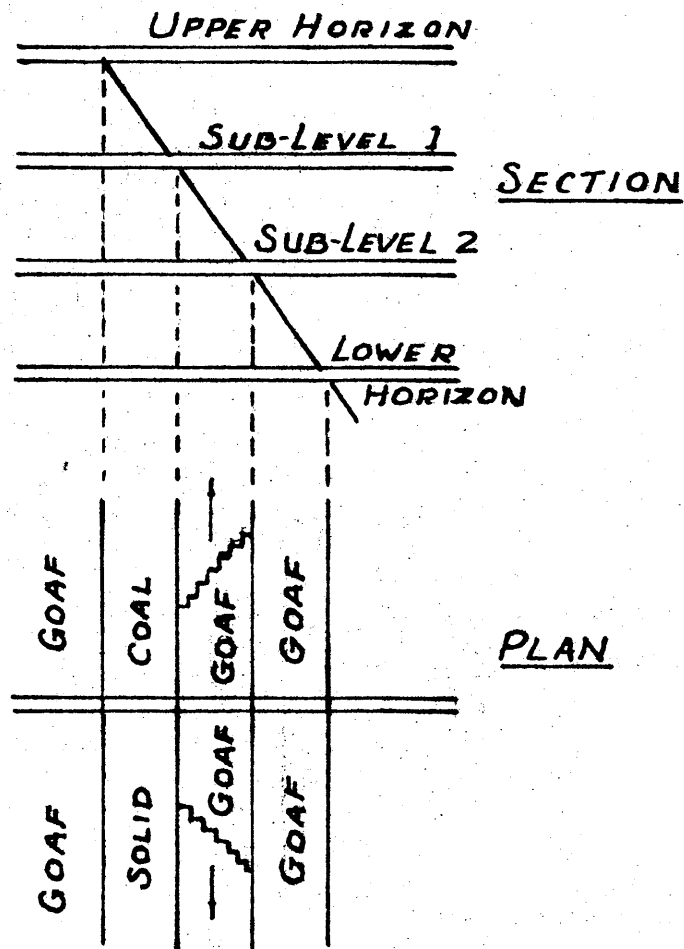

FIGURE 93

Layout of working faces in steep measures

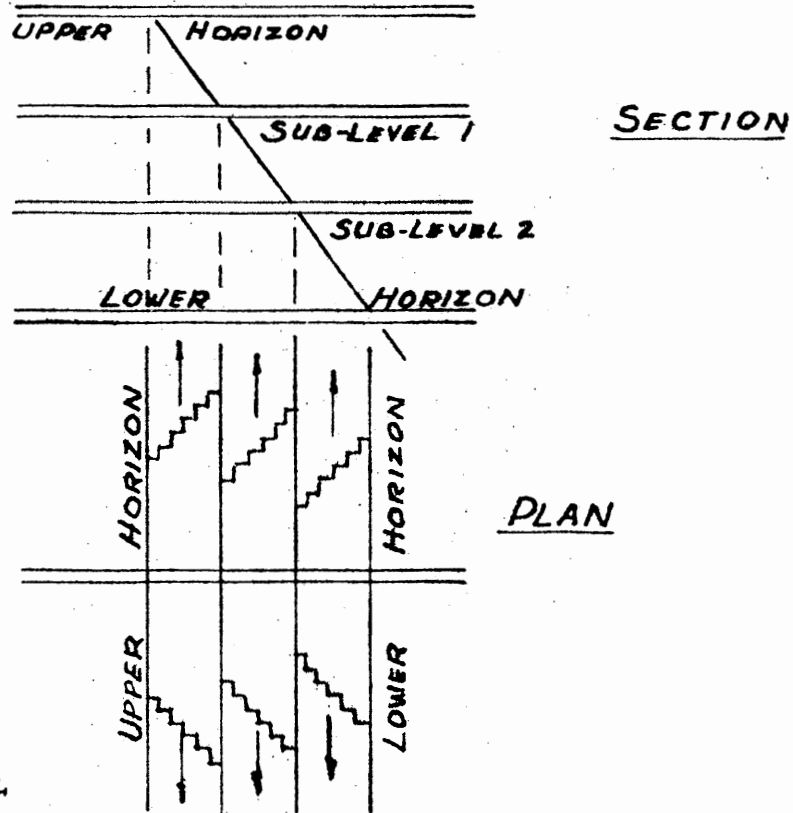

FIGURE 94

Layout of working faces in steep measures

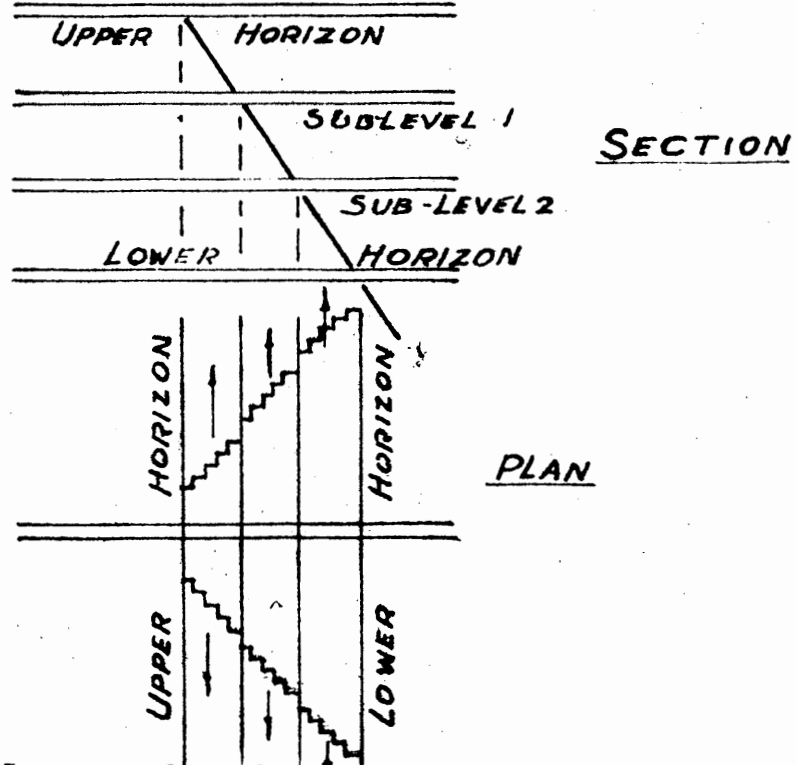

FIGURE 95 Layout of working faces in steep measures

faces laid out diagonally and advancing in the direction of the strike and driven from the sub-level cross-measure drifts. Each section is worked independently. This method has the advantage that the development required before the faces produce takes the least possible time and the gate roads, which are driven for the waste transport in the first instance, are later used for the transport of coal from the next and higher face between sub-levels. The disadvantages are: (1) excessive gas emission from the upper sub-level gate road which is driven in solid and (2) the last remaining coal pillar lying at the extremities of the upper section will probably be surrounded completely by waste. The concentration of pressure on these pillars causes roof trouble and possible rock bursts and so makes the extraction of the pillars difficult. This method is therefore not generally recommended.

In the second method the sequence of extraction is just the reverse of that given in the first method. The disadvantages of first method do not generally arise but other difficulties do. The gate roads which are first used for coal transport are not in suitable conditions for further use as waste transport roads for the next two lower faces.

This method is sub-divided into two systems in which all the sections are worked simultaneously as shown in Figures 94 and 95. The method shown in Figure 94, in which extraction is carried out in descending order, has a major disadvantage. Coal crush occurs at the corners formed

between the coal face and the upper gate roads, and this coal may run down onto the working face. Ventilation is also difficult at these junctions where pressure losses are high and leakage through the waste to the upper return airway may take place.

The alternative method, shown in Figure 95, is considered to be the best. The sharp junctions are avoided and the face line is almost continuous between horizons. Rock bursts are infrequent; the rock pressure not being concentrated on the remaining coal pillars since the roof on the whole unit has not yet settled as in the case described in the first method.

CHAPTER VI

SUMMARY AND CONCLUSIONS

Efficient control of the strata, associated with the seam or seams under extraction, is of prime importance to successful mining operations. Due to various indeterminate and unpredictable factors involved, there has been a tendency to believe that the behavior of the strata in individual mines can be discovered only by trial and error. But as a result of continued research into the problems caused by depletion of shallow seams and the consequent working of seams at increased depths, sufficient information is now available for the establishment of the guiding principles which will eliminate much costly experimental work. Such researches have helped engineers considerably in the design of mine workings.

The development work in room and pillar mining, after the seam is penetrated by the shafts or slopes was once considered to be very expensive and time consuming. But the present day practice of driving three or more completely mechanized development headings for the purpose of opening panels has completely changed this concept. Mechanization, in such a large number of development headings not only gives higher production but also improves the ventilation; both during the development stage and also throughout the life of the mine.

In level or nearly level seams these development headings can be worked with conventional equipment, i.e., mobile

coalcutters, loaders, drills and shuttle cars and either belt or track haulage. The workings, in such seams may also be arranged for exploitation using a continuous miner, shuttle cars and belt or track haulage. In pitching seams where mobile machines cannot be used, the development workings can be equipped with non-mobile coalcutters, loaders and chain and belt conveyors and the main haulage can be effected by either belt conveyor or locomotive. Similar procedures can be adopted in the development of longwall workings.

Extraction of panels in room and pillar work can be arranged in various ways depending upon pitch and thickness of the seam, type of equipment to be used and whether surface subsidence can be permitted. The panels can be worked with long and wide rooms or with narrow openings. In the former case, the percentage of extraction in the first working is higher than that of the latter. In both cases, pillars may be taken on the retreat. When surface subsidence is undesirable and caving cannot be allowed, the rooms are made wider in the first working and small pillars are left for permanent support of the overburden. In such cases, 40 to 50 percent coal is lost. However, if packing is adopted, complete extraction can be had. During the extraction of pillars, a diagonal fracture line is normally maintained so as to produce regular breaks in the roof over the goaf. This relieves pressure on the adjoining pillars. The machinery that is used during development work can also be used in working the panels.

Longwall mining is best suited to deep mines where effective roof control is essential for safe and efficient extraction. This method can also be employed in thin-seam workings under shallow cover where room and pillar work is difficult to adopt due to limited head room. Faces can be equipped with conventional machinery such as the longwall coalcutter, the drill and face conveyor or they can be arranged for continuous mining operations. Coal extraction is possible with or without packing. The percentage of extraction is higher in longwall operations than in room and pillar workings.

Horizon mining is employed generally in deep mines with high seam-density and pitching seams where large outputs are desired. The seams are extracted in descending order between horizons (levels). As the network of roadways in each horizon is nearly horizontal and driven in rock, the transport system can be made highly efficient. The method of coal extraction within the individual seams, at each horizon, is by the longwall system.

Coal mining has always been regarded as being amongst the most dangerous of all industrial occupations with a high death and accident rates. This was inevitable in view of dangers associated with the winning of coal. Careful study and research on the behavior of roof and coal pillars during different phases of mining operations have helped in the proper design of mine workings. Thus the present day mining methods could be scientifically planned and designed for

large outputs with a high degree of mechanization. Due to fewer men being employed as a result of mechanization and with increased safety due to scientific mine planning there has been a considerable reduction in accident rates.

BIBLIOGRAPHY

1. Adock, W.J. (1955-56) "Strata Control Research," Transactions - Institute of Mining Engineers, vol. 115, pp. 918-928.
2. Alder, H., Potts, S.W. and Walker, A. (1950-51) "Mechanized Room and Pillar Mining. A General Appreciation of Developments in Great Britain," Transactions - Institute of Mining Engineers, London, vol. 110, pp. 729-737.
3. Alder, H. (Chairman) (1953-54) "Control of the Strata in Mining: Investigations in the Durham and Northumberland Coalfield," Transactions - Institute of Mining Engineers, London, vol. 113, pp. 83-93.
4. Alder, H. (President and Chairman) (1948-49) "Seventh Progress Report of an investigation into the causes of falls and accidents due to falls - the improvement of working conditions by the controlled transference of roof load," Transactions - Institute of Mining Engineers, London, vol. 108, pp. 489-510
5. Benson, J.B., Sanford, H.E. and Stahl, R.W. (1950), "Conditions and Practices at Coal Mines in the Ruhr District of Western Germany," Information Circular No. 7549, U.S. Bureau of Mines.
6. Carver, J. and Jones, T.J. (1957-58), "The Influence of Modern Hydraulic Props at a Roadhead disturbed by Previous working," Transactions - Institute of Mining Engineers, London, vol. 117, pp. 27-37.
7. Cunningham, J.H. (Director of Public Relations), (1956) "Bituminous Coal Trends," National Coal Association, Washington.
8. Downend, G.J. (1954-55) "A Prop-Free-Front Face in a seam 8 ft. 6 in. thick and inclined at 1 in 2½," Transactions - Institute of Mining Engineers, London, vol. 114, pp. 927-938.
9. Eavenson, H.N. (1942) "Coal through the Ages," Second Edition, American Institute of Mining and Metallurgical Engineers.
10. Engineer, B.H. and Sharma, R.N. "Extraction of a 28-foot thick seam with Hydraulic Sandstowing," Indian Mining Journal, Special Issue 1958, pp. 35-37.
11. Fritzsche, C.H. and Potts, E.L.J. (1954) Horizon Mining, George Allen & Unwin, Ltd., London, pp. 1-93.

12. Given, Ivan A., (Editor) "The Deep-Mining Guidebook," Coal Age, vol. 62, Mid-July 1957, pp. 22-101.
13. Given, Ivan A., (Editor) "How Peabody Mines 26-in. Seam in Kentucky," Coal Age, vol. 62, April 1957, pp. 60-64.
14. Given, Ivan A., (Editor) "Flexible Continuous Mining," Coal Age, vol. 63, November 1958, pp. 100-102.
15. Given, Ivan A., (Editor) "Productive Continuous Mining under difficult conditions," Coal Age, vol. 63, July 1958, pp. 86-89.
16. Given, Ivan A., (Editor) "Preparing for Continuous Mining," Coal Age, vol. 62, May 1957, pp. 70-77.
17. Given, Ivan A., (Editor) "The Deep-Mining Guidebook," Coal Age, vol. 60, Mid-September 1955, pp. 4-61.
18. Given, Ivan A., (Editor) "Longwall with the Dosco Miner," Coal Age, vol. 58, December 1953, pp. 84-88.
19. Greensmith, J.Victor (1951-52) "Some Aspects of American Coal Mining Practice," Transactions - Institution of Mining Engineers, London, vol. 111, pp. 795-809
20. Guin, M.N. "Longwall Workings in Dishergarh Seam," Indian Mining Journal, Special Issue 1958, pp. 85-88.
21. Haley, W.A., Shields, J.J., Toenges, A.L. and Turnbull, L.A. (1952) "Mechanical Mining in some Bituminous-Coal Mines," Report 6, Information Circular No. 7631, U.S. Bureau of Mines.
22. Haley, W.A., Dowd, J.J. and Turnbull, L.A. (1952) "Modified Longwall Mining with a German Coal Planer (Flow) in the Pocahontas No. 4 Coal Bed, Helen, W.Va.," Report of Investigations 4922, U.S. Bureau of Mines.
23. Harley, P.L. (1953) "Continuous Mining Schemes," The Colliery Guardian, vol. 186, pp. 529-535.
24. Jones, D.C. (1948) Coal Mining, vol. III, Mineral Industries Extension Services, School of Mineral Industries, The Pennsylvania State College, Pennsylvania, pp. 244-340.
25. Jones, C.R.L. (1949-50) "Underground Gasification," Transactions - Institute of Mining Engineers, London, vol. 109, pp. 1025.

26. Leek, I.G.E. (1955-66) "The Selection and Application of Longwall Power-loading Machine," Transactions - Institute of Mining Engineers, London, vol. 110, pp. 732-742.
27. Masterton, W.F. (1950-51) "Mining Methods in the Kaiping Coalfield, North China," Transactions - Institute of Mining Engineers, London, vol. 110, pp. 708-722.
28. Peele, Robert (1959) Mining Engineers' Handbook, vol. 1, Third Edition, John Wiley & Sons, Inc., New York., pp. 10/472-511.
29. Peters, T.W. (1953-54) "Some Aspects of Coal face Mechanization," Transactions - Institute of Mining Engineers, London, vol. 113, pp. 283-294.
30. Potts, M.C. "Mining with the cutter-loader," Coal Age, vol. 57, January 1952, pp. 95-102.
31. Reid, ___ (1945) Coal Mining, Report of the Technical Advisory Committee, His Majesty's Stationary Office, London, Cmd. 6601.
32. Sheppard, W.V. (1950-51) "An Experiment in Continuous Longwall Mining at Bolsovar Colliery," Transactions - Institute of Mining Engineers, London, vol. 110, pp. 475-484.
33. Shields, J.J., Magnuson, M.O., Haley, W.A. and Dowd, J.J. (1954) "Mechanical Mining in some Bituminous-Coal Mines," Progress Report 7, Information Circular No. 7696, U.S. Bureau of Mines.
34. Sinha, K.N. "Some Aspects of Strata Control," Indian Mining Journal, Special Issue 1958, pp. 89-96.
35. Slone, E.D. "Pillar Extraction with Continuous Miners," Coal Age, vol. 63, January 1958, pp. 92-96.
36. Stahl, R.W. and Dowd, J.J. (1954) "Mining with a Dosco Continuous Miner on a longwall face," Information Circular No. 7698, U.S. Bureau of Mines.
37. Statham, I.C.F. (1958) Coal Mining Practice, vols. 1 & 2, The Caxton Publishing Company, Ltd. London, pp. 261-325 & pp. 1-174 resp.
38. Toenges, A.L. and Anderson, R.L. (1938) "Multiple-shift Mechanical Mining in some Bituminous Coal Mines," Progress Report 1, Information Circular No. 7014, U.S. Bureau of Mines.

39. Toenges, A.L. and Jones, F.A. (1939) "Multiple-shift Mechanical Mining in some Bituminous-Coal Mines," Progress Report 2, Information Circular No. 7067, U.S. Bureau of Mines.
40. Toenges, A.L. and Maize, E.R. (1941) "Multiple-shift Mechanical Mining in some Bituminous-Coal Mines," Progress Report 3, Information Circular No. 7178, U.S. Bureau of Mines.
41. Toenges, A.L., Maize, E.R. and Jones, F.A. (1942) "Multiple-shift Mechanical Mining in some Bituminous-Coal Mines," Progress Report 4, Information Circular No. 7223, U.S. Bureau of Mines.
42. Toenges, A.L. and Fish, E.L. (1949) "Coal Mining Methods and Practices in Western Arkansas, Preliminary Investigation," Report of Investigations 4448, U.S. Bureau of Mines.
43. Turnbull, L.A. and Toenges, A.L. (1949) "Mechanical Mining in some Bituminous-Coal Mines," Progress Report 5, Information Circular No. 7527, U.S. Bureau of Mines.
44. United States Steel Corporation, Coal Mines Staff, Tennessee Coal & Iron Division, Alabama, "Thin-Seam Continuous Mining Pays off at TCI," Coal Age, vol. 65, February 1960, pp. 98-102.
45. Valeri, M. "Pittsburgh-seam Pillaring with continuous Miners," Coal Age, vol. 62, March 1957, pp. 58-60.
46. Van Praag, L.L. and Jackson, R.R.G.P. (1949-50) "The Planning of Pit-bottom," Transactions - Institute of Mining Engineers, London, vol. 109, pp. 1060-1097.
47. Walker, John (Chairman) "Report of the Safety in Mines Research Committee," Transactions - Institute of Mining Engineers, London, vol. 106, pp. 467-479.
48. Walker, Arthur "Memorandum on the Design of Mine Workings to secure effective strata control," Transactions - Institute of Mining Engineers, London, vol. 110, pp. 252-271.
49. Walkerdine, R.H. (Editor) "A Modern Ruhr Coal Plough Installation," The Colliery Guardian, vol. 179, pp. 455-458.

VITA

Hemendra Nath Datta was born February 1, 1925 at Sibsagar, Assam, India. After the successful completion of his studies at a local high school in 1940, he was admitted to Presidency College, Calcutta, from which he obtained the Degree of Bachelor of Science in 1944.

He was graduated with a Diploma in Mining Engineering from Indian School of Mines & Applied Geology, Dhanbad, in the year 1949.

After completion of his post-graduate training in coal mines, he passed the Second Class Mine Managers' Certificate of Competency and Mine Surveyors' Certificate of Competency examinations in 1951. He was then employed as Undermanager in coal mines until 1954 when he joined Indian School of Mines & Applied Geology as Lecturer in Mining Engineering. Later he became Senior Lecturer in which capacity he worked until June, 1957. Again he joined the industry as colliery manager and in May, 1958 he was appointed as Assistant Professor in Mining Engineering at Indian Institute of Technology, Kharagpur. He is still employed there and he has come to this country for his studies in Master of Science in Mining Engineering under the International Cooperation Administration Program.

He was married in July, 1952.

