

01 Dec 1978

High-flux Beam Source Of Fast Neutral Helium

D. W. Fahey

Laird D. Schearer

Missouri University of Science and Technology

William F. Parks

Missouri University of Science and Technology, wfparks@mst.edu

Follow this and additional works at: https://scholarsmine.mst.edu/phys_facwork

 Part of the [Physics Commons](#)

Recommended Citation

D. W. Fahey et al., "High-flux Beam Source Of Fast Neutral Helium," *Review of Scientific Instruments*, vol. 49, no. 4, pp. 503 - 506, American Institute of Physics, Dec 1978.

The definitive version is available at <https://doi.org/10.1063/1.1135449>

This Article - Journal is brought to you for free and open access by Scholars' Mine. It has been accepted for inclusion in Physics Faculty Research & Creative Works by an authorized administrator of Scholars' Mine. This work is protected by U. S. Copyright Law. Unauthorized use including reproduction for redistribution requires the permission of the copyright holder. For more information, please contact scholarsmine@mst.edu.

RESEARCH ARTICLE | AUGUST 08 2008

High-flux beam source of fast neutral helium

D. W. Fahey; L. D. Scheerer; W. F. Parks





Rev Sci Instrum 49, 503–506 (1978)

<https://doi.org/10.1063/1.1135449>

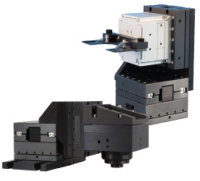
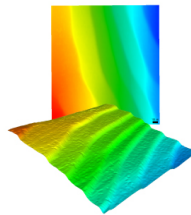
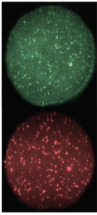

CrossMark

 <p>MCL MAD CITY LABS INC. www.madcitylabs.com</p>	<p>Nanopositioning Systems</p> 	<p>Modular Motion Control</p> 	<p>AFM and NSOM Instruments</p> 	<p>Single Molecule Microscopes</p> 
--	--	--	---	--

High-flux beam source of fast neutral helium

D. W. Fahey, L. D. Scheerer,^{a)} and W. F. Parks

Physics Department, University of Missouri, Rolla, Missouri 65401

(Received 15 November 1977; in final form, 27 December 1977)

A high-flux beam source of fast neutral helium has been constructed by extending the designs of previous authors. The source is a dc or pulsed electric discharge in an expanding gas nozzle. The beam produced has a flux on the order of 10^{15} atoms/ssr and a mean velocity on the order of 10^7 cm/s. The composition of the beam has been determined by the use of particle detectors and by the observation of the excitation of certain target gases. An upper bound of 3.7×10^{-5} has been estimated for the $\text{He}(2^3S_1)/\text{He}(1^1S_0)$ beam density ratio and a value of 0.2 found for the $\text{He}^+/\text{He}(1^1S_0)$ beam density ratio.

INTRODUCTION

The construction of high-flux metastable beam sources has been previously reported in this journal by J. Q. Searcy¹ and E. L. Leasure *et al.*² Both designs used an expanding gas nozzle and skimmer arrangement with a continuous high-voltage dc discharge in the expanding gas. In both designs, the sources produced helium metastable atoms with a total flux of less than 10^{12} atoms/s sr and with energies lower than 5 eV.

In this article we report the design, construction, and characterization of a source which produces a dc or pulsed beam of predominantly helium ground state neutral atoms at energies of approximately 1 keV and fluxes exceeding 10^{15} atoms/s sr. The high beam densities considerably simplify the observation of optical emission resulting from the collision of the fast neutral helium atoms with impurity species in the interaction region. Time-of-flight measurements, pulsed excitation of the source, and the observation of optical emission spectra from strontium as a target gas, are used to characterize the source. The characterization of the source by optical detection of reactions with impurities is thought to be a significantly more decisive test for the presence of metastables than the use of particle multipliers or total scattering measurements.

I. SOURCE DESIGN

The source is essentially a high-voltage discharge maintained between a sharp needle and a cone-shaped anode with a small hole at the apex. The discharge exists across a substantial pressure gradient created by differentially pumping a gas nozzle. The needle tip was in the pressure range of 40–80 Torr while in front of the anode the pressure was maintained in the vicinity of 2.5×10^{-4} Torr. In the region behind the anode (the reaction region) the background pressure was less than 5×10^{-6} Torr.

Our source design is shown in Fig. 1. A Cajon Ultra-Torr fitting is mounted in a vacuum chamber wall and seals around a 7-mm-o.d. Pyrex glass tube (a) that extends several centimeters into the chamber. A machined piece of boron nitride (b) forms a cap

for the end of the glass tube and a small hole drilled in this serves as the nozzle. The skimmer is a cone-shaped piece of stainless steel (c) with a small hole at the apex. Behind the nozzle, inside the glass tube is a common nickel plated sewing needle (d) supported to lie along the axis of the tube. The skimmer piece is attached with nonconducting epoxy to a vacuum wall to allow differential pumping of the source. This created two independently evacuated regions that will be referred to as the source and reaction region, respectively. A relatively slow 300-l/s diffusion pump was attached to the source region. The positive high voltage needed to initiate and sustain the discharge was provided between the needle (anode) and the skimmer (cathode). Research grade helium was metered into the glass tube behind the nozzle by a micrometer leak valve. Absolute nozzle pressure measurements were made with a Wallace and Tiernan dial gauge. A triode ionization gauge was used as an indirect measure of the nozzle pressure and a means to alter the pressure reproducibly.

Our source was capable of being operated by creating either a dc or pulsed discharge in the expanding gas. The dc discharge used a conventional Fluke 410B high-voltage power supply (0–10 kV, 0–10 mA) with over-current protection. The pulsed mode used a 5C22 hydrogen thyratron to transfer the energy in a $0.012\text{-}\mu\text{F}$ low-inductance capacitor to the discharge region.

The operation of the discharge was quite simple.

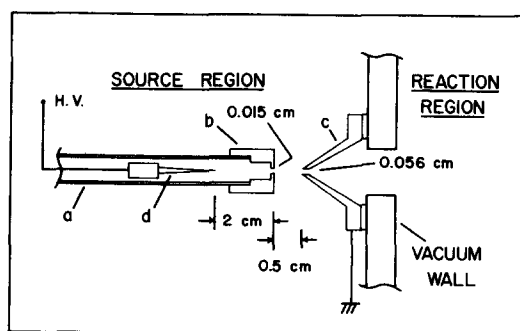

FIG. 1. Beam source schematic indicating Pyrex tube (a), boron nitride nozzle (b), skimmer (c), and needle (d).

After obtaining an initial high vacuum in the chamber, helium was allowed to bleed into the region behind the nozzle by opening the leak valve. At a nozzle pressure of 50 Torr, a dc voltage above 4 kV initiates and sustains the discharge. In the same pressure range, a 5–10 kV charge on the capacitor in the pulsing circuit would consistently initiate the discharge at each pulse with a repetition rate up to 200 Hz. The upper limit on the repetition rate was primarily determined by the power limitations of the circuit components.

The discharge was easily visible to the eye as a pinkish-orange glow between the nozzle and skimmer in both the pulsed and dc mode of excitation. The discharge activity was confined under normal conditions to a cylindrically shaped volume extending from the nozzle to the skimmer hole with a perceived radius of several skimmer hole diameters. Behind the nozzle inside the glass tube the discharge was more intense and confined between the needle tip and nozzle hole.

The intensity of the discharge seemed to be given by the product of pressure and voltage, where the intensity would be a qualitative measure of the ionizing activity outside the nozzle. For nozzle pressures near 80 Torr and above and for dc or pulsed voltages of 9–10 kV, the discharge would become unstable as evidenced by arcing between the nozzle and ground walls and by the ignition of a weak discharge in the entire source region. The highest stable intensity that the source could maintain was essentially determined by the pumping speed in the source region. At all values of the source parameters for which arcing to ground would not occur, the output of the source as measured by particle currents was extremely stable and reproducible for both the pulsed and dc modes.

II. BEAM DIAGNOSTICS

To properly characterize the source, it was necessary to determine the different component species of the beam and their respective velocities. Since the interest in our laboratory is in both the metastable and ground state neutral helium, our primary effort was to analyze the beam for these two species by two basic methods.

A. Particle detection method

In the first method, a Faraday cup and a particle multiplier were used. Specifically, the Faraday cup was a 2.5-cm-diam by 2.5-cm-deep thin-walled stainless-steel cup with a coarse nickel mesh bias grid. In this arrangement, the cup was capable of a nearly absolute measurement of the charged components of the beam, assuming the ions were singly charged. With the proper bias the secondary electron current from the neutral beam flux was also measured. In general, since the coefficient of electron ejection is easily determined only for atomically clean surfaces, absolute measurements of the neutral flux were precluded although relative measurements were still valid.

The particle multiplier used was an EMI/GENCOM 9603/2B windowless electron multiplier. As a general rule the multiplier is not sensitive to particles with less total energy than approximately 20 eV for helium. This implies that helium metastables of negligible translational energy would be detected since they possess approximately 20 eV internal energy while helium ground state neutrals would be required to have at least 20 eV in kinetic energy corresponding to a velocity of 3.1×10^6 cm/s. The threshold for efficient photon detection is lower and would include wavelengths on the order of 200 nm or less.

The usefulness of both detectors was enhanced by the simultaneous use of electrostatic sweep plates which permit the removal of any charged component from the beam and the ratio of charged components to neutral components to be determined.

B. Optical emission spectra from elemental impurity

The second method of particle detection was the observation of the excitation produced by the beam in an elemental impurity whose vapor was titrated into the beam path. Optical signals were monitored as evidence of target excitation. This method was crucial in determining the metastable flux since their principal reaction with elemental impurities is through the Penning ionization reaction which yields only ionic states of the impurity. These reactions have been well studied in flowing afterglow experiments and the characteristic spectra recorded for various elements.^{3,4} In this work, the class of group II elements, primarily strontium, were used as targets since their characteristic Penning spectra have been measured in our laboratory.⁴ The characteristic neutral and ion emission from the target impurities was identified using the Charlotte Moore tables of atomic energy levels.⁵

The high flux yield of the source permitted simple integration techniques to observe the emission spectrum of the target in both the dc and pulsed operating modes. The optical detection apparatus consisted of a quartz lens and a 0.25-m Jarrell-Ash monochromator using a 9783B EMI/GENCOM photomultiplier mounted outside the vacuum region chamber at 90° with respect to the beam axis. The effective solid angle of the detection system was 2.1×10^{-3} sr. The impurity vapor was introduced into the beam path by resistively heating a small crucible of the element inside the vacuum region in close proximity to the beam.

The optical emission from a strontium target excited by the beam is shown in Fig. 2. As seen in the sample spectrum for the beam interaction with strontium, the optical emission is dominated by two lines of wavelength 407.9 and 460.9 nm. From the table of atomic energy levels, these lines correspond to transitions in the ion and neutral species of strontium, respectively. The ratio of ion excitation to neutral excitation is seen to be approximately 0.25. The charged component of the beam, presumably He⁺, produced approximately 50% of the ion emission and made a negligible con-

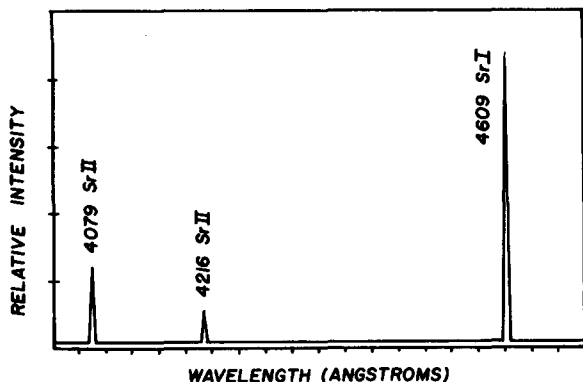

Fig. 2. Partial emission spectrum of strontium excited by the source yield of neutral ground state helium atoms.

tribution to the neutral strontium emission. The conclusion is made that the neutral components of the beam excite the neutral levels of strontium at a rate approximately 8 times greater than levels of the strontium ion.

The neutral beam may contain both the ground state helium atoms as well as metastable components. The intensity ratio found above may now be used to provide an upper limit on the density of the metastable components. Since helium metastable atoms can only Penning ionize the impurity, the observation of strontium neutral emission must be attributed to excitation by collisions with helium ground state neutral atoms. The excitation of the observed level at $21\,698\text{ cm}^{-1}$ in strontium requires a minimum helium atom velocity of $1.1 \times 10^6\text{ cm/s}$.

Using experimental values for related Penning ionization cross sections and a value for the cross section for neutral excitation by fast neutrals, a value for the ratio of metastables to fast ground state neutrals in the beam can be estimated. The values for the Penning ionization cross sections for zinc and cadmium are known from pulsed afterglow experiments.⁶ The average value of these cross sections of $3.7 \times 10^{-15}\text{ cm}^2$ is used as a good approximation to the strontium cross section. In the case of neutral excitation, the cross section for excited target emission at a specific wavelength is expected to be smaller than the relatively large Penning cross sections. Kempter has reviewed neutral-neutral collisions and compiled estimated absolute emission cross sections for various systems.⁷ The neon emission cross sections for He on Ne at 920 eV were thought to closely represent similar cross sections for He on Sr at 800 eV. Therefore, as a first approximation a value of $1.1 \times 10^{-18}\text{ cm}^2$ was chosen to represent the neutral excitation cross section. Thus, using the cross-section ratio and the ratio of observed optical signals, the metastable to neutral ground state flux ratio is calculated to be 3.7×10^{-5} . This value most importantly represents an upper bound on the flux ratio which is clearly much less than unity.

A search for source conditions that would enhance the ion excitation over the neutral excitation was unsuccessful. The source was characterized as varying con-

tinuously with its parameters, the most important of which would be the nozzle pressure, anode voltage, pumping speed, and the relative spacing of the nozzle components. Variations over the range of useful values resulted primarily in a change in overall intensity of the beam and not in the character of the output as measured by the excitation ratio. As a representative example, Fig. 3 shows the level of neutral excitation as a function of anode voltage at a typical operating pressure. The related group II elements calcium and cadmium were also used as the impurity with the result that a characteristic neutral line was also populated over a characteristic ion line by the same ratio observed in strontium.

C. Particle flux and velocity measurements

The particle multipliers were used for time-of-flight analysis and particle flux measurements. In computing values for the beam flux, two assumptions were made. First, it was assumed that all ion excitation not due to charged components would be attributed to the metastable species and that the resultant value for the metastable flux would represent an upper limit. Implicit in this assumption is the fact that the photon contribution to ion excitation is being neglected. This fact is supported by the absence of a significant photon peak in the time of flight analysis and the relatively lower cross section. Second, the threshold of 20 eV for the multiplier was thought not to exclude the detection of relevant particles because charged components were likely to have energies on the order of the anode voltage, metastables have 20 eV of internal energy, and neutrals were assumed to have been formed from energetic ions. This assumption is self-consistent since the neutral flux was measured to have an average energy of 800 eV.

Using the particle multiplier, 20% of the beam in the pulsed and dc mode was found to be charged. To avoid using a value for the multiplier gain, the biased Faraday cup was used to get an absolute value for

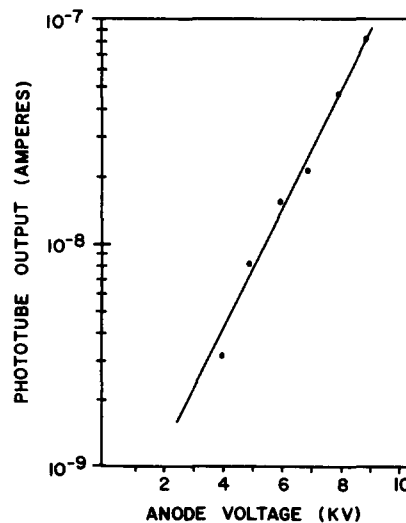

Fig. 3. Strontium neutral emission at 460.9 nm due to neutral ground state excitation as a function of source anode voltage.

the charged current. A typical value of 5×10^{-8} A for the charged current yields a value of 1.56×10^{12} particles/s for the total flux incident on the multiplier. Using the effective solid angle of 4.9×10^{-4} sr, the total particle flux is determined to be 3.2×10^{15} particles/s sr.

A velocity measurement by time of flight was made with the multiplier which could be moved under vacuum as much as 60 cm and therefore avoided the difficulty of determining a zero in time. The measurement was made by noting the shift in the leading edge of the particle signal for an *in situ* displacement of the multiplier. In the pulsed mode, the width of the particle pulse was 0.5×10^{-3} s with an average velocity of 2×10^7 cm/s corresponding to an energy of 800 eV for helium. In the dc mode a chopper wheel or a voltage pulse to the skimmer were used to effectively pulse the beam for the velocity measurement. It was not possible to measure accurately the distribution of velocities in the beam with either simple chopper or pulsed techniques due to the extremely short flight time of the particles for the maximum multiplier displacement. The observations did indicate however that there were no particles, either ions, metastables, or neutral ground states, with energies below 100 eV.

The optical excitation signal from the impurity, which would be observed simultaneously with the particle multiplier signal, was always seen to have the same pulse shape and same position in time as the particle signal. This allowed one to confidently conclude that the particles causing the excitation were indeed the particles detected by the multiplier.

ACKNOWLEDGMENT

This research was supported by the Office of Naval Research.

- ¹⁾ Visiting Scientist, Joint Institute for Laboratory Astrophysics, National Bureau of Standards, University of Colorado.
- ¹ J. Q. Searcy, *Rev. Sci. Instrum.* **45**, 589 (1974).
- ² E. L. Leasure, C. R. Mueller, and T. Y. Ridley, *Rev. Sci. Instrum.* **46**, 635 (1975).
- ³ R. C. Bolden, R. S. Hemsworth, M. J. Shaw, and N. D. Twiddy, *J. Phys. B* **3**, 61 (1961).
- ⁴ L. D. Schearer and F. H. K. Rambow (to be published).
- ⁵ Charlotte E. Moore, *Atomic Energy Levels Derived from the Analysis of Optical Spectra* (Government Printing Office, Washington, 1971), Vol. I–III.
- ⁶ L. A. Riseberg, W. F. Parks, and L. D. Schearer, *Phys. Rev. A* **8**, 1962 (1973).
- ⁷ V. Kempter, *Molecular Scattering: Physical and Chemical Applications*, edited by K. P. Lawley (Wiley, New York, 1975), Vol. XXX, p. 417.