

15 Sep 2017

Cyclic Compression Behavior of Concrete-Filled Hybrid Large Rupture Strain FRP Tube

Monika Nain

Mohanad M. Abdulazeez

Mohamed ElGawady

Missouri University of Science and Technology, elgawadym@mst.edu

Follow this and additional works at: https://scholarsmine.mst.edu/civarc_enveng_facwork



Part of the [Structural Engineering Commons](#)

Recommended Citation

M. Nain et al., "Cyclic Compression Behavior of Concrete-Filled Hybrid Large Rupture Strain FRP Tube", Sep 2017.

This Article - Conference proceedings is brought to you for free and open access by Scholars' Mine. It has been accepted for inclusion in Civil, Architectural and Environmental Engineering Faculty Research & Creative Works by an authorized administrator of Scholars' Mine. This work is protected by U. S. Copyright Law. Unauthorized use including reproduction for redistribution requires the permission of the copyright holder. For more information, please contact scholarsmine@mst.edu.

Cyclic Compression Behavior of Concrete-Filled Hybrid Large Rupture Strain FRP Tubes

Monika Nain¹, Mohanad M. Abdulazeez², Mohamed A. ElGawady³

1 Graduate Research Assistance, Dept. of Civil, Architectural, and Environmental Engineering, Missouri University of Science and Technology, Rolla, MO. 65409

2 Graduate Research Assistance and PhD student, Dept. of Civil, Architectural, and Environmental Engineering, Missouri University of Science and Technology, Rolla, MO. 65409

3 Benavides Associate Professor, Dept. of Civil, Architectural, and Environmental Engineering, Missouri University of Science and Technology, Rolla, MO. 65409

ABSTRACT

This paper experimentally investigates the behavior of concrete-filled-fiber-reinforced polymer (FRP) cylinders under cyclic axial compression. The FRP used in this study were either large rupture strain FRP (LRS-FRP) or hybrid LRS-FRP and conventional glass FRP (GFRP). LRS-FRP are manufactured out of polyethylene naphthalate (PEN) and polyethylene terephthalate (PET) obtained from recycled plastics. Hence, they are much cheaper and environment-friendly than conventional GFRP or carbon FRP (CFRP). LRS-FRPs has high tensile rupture strain (usually greater than 5%) compared to 1-2% for GFRP and CFRP. This study presents the results of 4 specimens with different confinement ratios to investigate the behavior of concrete-filled LRS-FRP or hybrid LRS-FRP and GFRP tubes in terms of ductility, ultimate strain, and strength improvement. The results showed that using LRS-FRP significantly improved the ductility of the confined concrete. However, the improvement in strength was limited. The hybrid confinement improves both the ductility and strength.

INTRODUCTION

Fiber reinforced polymer (FRP) composites have been found to be a very promising material in structural engineering because of their high strength, ductility, easy installation, and relatively low maintenance cost. The advantages also include corrosion resistance and lightweight nature in addition to excellent ductility compared to the steel and concrete jacketing, and thus, excellent seismic resistance. Both the strength and the ductility of concrete can be significantly increased by this lateral confinement form of FRP tubes, which applies tension on the FRP tube in the hoop direction.

In the past few decades, rapid growth has been observed in the application of FRP confining jackets for the strengthening/retrofitting of reinforced concrete columns. Carbon FRP, glass FRP, and Aramid FRP are the most common FRP composites used commercially. In recent years, a new type of FRP composites has emerged as an alternative to conventional FRPs (Youssf et al. 2014, Abdelkarim and ElGawady 2015 (a), Youssf et al. 2015, Moustafa and ElGawady 2016, Abdelkarim and ElGawady 2016). This new type of FRP composites consists of polyethylene naphthalate (PEN) and polyethylene terephthalate (PET) fibers. They are much cheaper and environment-friendly than the conventional FRP composites. PET and PEN FRP show bilinear stress-strain relationships with elastic and tangent modulus having large rupture strain of more than 6%. Hence, the new FRP composites are called large rupture strain FRPs (LRS-FRPs).

For the reliable and safe design of structural members, it is important to properly understand and model the stress-strain behavior of LRS-FRP confined concrete. Extensive study has been done in this field, but these studies have focused extensively on their monotonic behavior (Dai et al. 2011, Anggawidjaja et al. 2006). Studies show that concrete-filled FRP tubes with PET and PEN having large rupture strain could efficiently improve the ductility despite having low stiffness. At the ultimate state, the large strain allows the fiber composite to contribute enough shear force while avoiding fiber rupture (Dai et al. 2014). It is also observed that the LRS-FRP confined concrete's response increases almost linearly with the increase in the number of layers of FRP (Moon et al. 2012).

Many research studies have compared the behavior of concrete-filled FRP tubes (CFFT) with conventional FRPs (carbon, glass, and aramid) and LRS-FRPs (PET & PEN), but very few researchers have thought of combining both FRP materials and to studying the different combination, of both FRPs under monotonic axial compressive loading (Abdelkarim and ElGawady 2015). The presented study introduces an experimental investigation on the behavior of concrete-filled hybrid LRS-FRP and GFRP tubes under cyclic axial compressive loading. This study explains the seismic behavior of such FRP in terms of ductility and strength improvement.

EXPERIMENTAL WORKS AND INSTRUMENTATIONS

Four specimens of different confinement ratios were made by manual wet lay up of FRPs around the sonotube, and concrete was poured in one batch in the FRP tubes. The variables in this test were confinement ratio and the number of layers. All cylinders had a cross section of 156 mm x 305 mm. Cylinders were tested after 28 days under cyclic axial compression (Table 1).

Four CFFT were fabricated by wrapping a manual wet layup process around the sonotube using epoxy with 30% overlap of the FRP layer. Three different types of FRPs (glass, PET, and PEN) were used. The properties of PET and PEN were determined from coupon test and glass properties provided by the manufacturer (TYFO® SHE-51) were used for investigation. Coupons of PET and PEN FRP composites were prepared and tested according to ASTM D3039 (Table 2).

All FRP cylinders were poured in one batch, and the compressive strength of the concrete cylinders was 55 MPa after 28 days. The concrete mix design is shown in Table 3.

Table 1. Parametric Study

Cylinder Label	Parameter	Diameter (mm)	Height (mm)	FRP-Layers	LRSFRP-Thickness (mm)	Glass FRP Thickness (mm)	f _c (MPa)	Confinement Ratio
P11	PET-Glass (in/out)	156	305	1PET-2GLASS	3.3	2.54	48.2	0.53
P13	PEN-Glass (in/out)	156	305	1PEN-2GLASS	3.0	2.54	48.2	0.57
P14	PET-Glass (out/in)	156	305	2GLASS-1PET	3.3	2.54	48.2	0.49
P16	PEN-Glass (out/in)	156	305	2GLASS-1PEN	3.0	2.54	48.2	0.57

Table 2. Properties of FRP

Properties	Glass	PET	PEN
Thickness (mm)	1.27	3.3	3.0
E2 (GPa)	26.1	2.2	3.9
Ultimate Strain (%)	2.2	7.6	5.9

Table 3. Concrete Mix

w/c	Cement (kg/m ³)	Water (kg/m ³)	Fine aggregate (kg/m ³)	Coarse aggregate (kg/m ³)
0.5	451	226	512	512

The hoop and axial strain of the cylinders were measured by installing strain gauges at mid-height (152 mm) of the cylinder. Both strain gauges were fixed at eight positions at regular intervals (respective position of strain gauges is shown in Figure1)

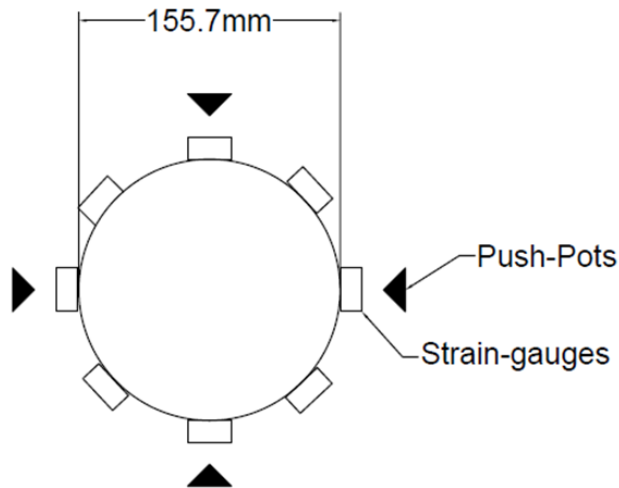

Figure 1. Positions of strain gauges.

Four pushpots, spaced equally, were installed in the middle third height of the specimen for local analysis of displacement, and two LVDTs that were 180° apart were installed at the top of the specimen to measure the global vertical displacement. The instrumentation layout is illustrated in Figure 2.

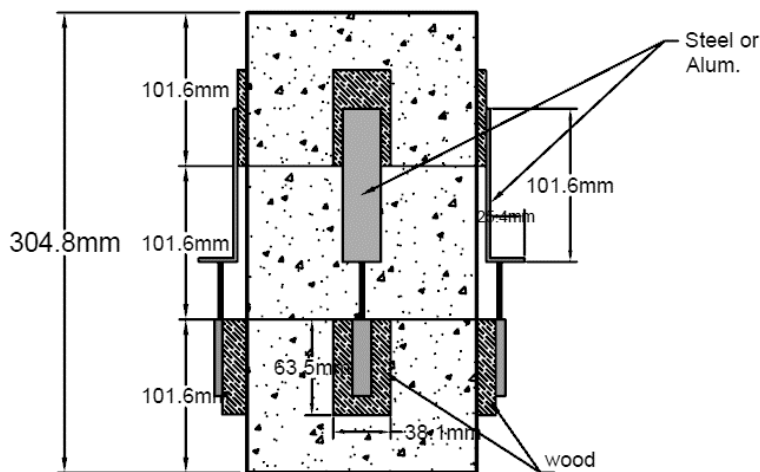

Figure 2. Instrumentation layout.

TEST LOADING PROTOCOL

Cylinders were tested using MTS 2500 with the capacity of 2,225 kN. The conducted test was displacement control with a constant loading rate of 0.5 mm/minute. The cylinders were subjected to cyclic axial compression loading and loaded until final rupture of FRP and data from strain gauges, pushpots and LVDTs were recorded by a data logger. MTS 2500 was preloaded to 44.5 kN at the start of the test. The four concrete-filled hybrid large-rupture strain FRP tubes specimens were tested under compression loading on the cyclic scheme, as shown in Figure 3. Each loading step was repeated for three cycles (Carter et al. 2014).

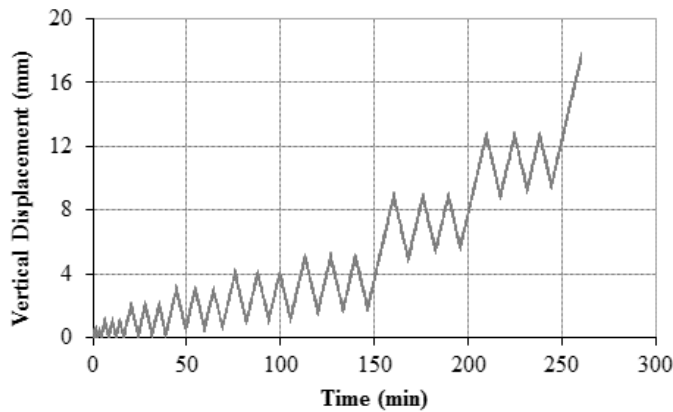

Figure 3. Cyclic compression loading regime.

RESULTS AND DISCUSSION

The behavior of concrete-filled hybrid LRS-FRP and GFRP tubes under cyclic axial compressive loading was investigated. As compared to conventional FRP, the new hybrid FRP composites have a large rupture strain of 4-6%. The compressive strength of FRP cylinder was increased significantly around three times that of the unconfined concrete cylinder. This increase was due to the lateral confinement provided by FRP tubes, which applied tension on the FRP tube in the hoop direction and prevented concrete failure.

A hybrid FRP system was investigated with different fiber sequences by placing GFRP at the inner surface (in) and PET FRP at the outer (out) surface and vice versa. The same installation sequence was repeated for GFRP and PEN FRP examined tubes. The concrete-filled hybrid LRS-FRP and GFRP tubes test results are shown in Figures 4, 5, 6, and 7.

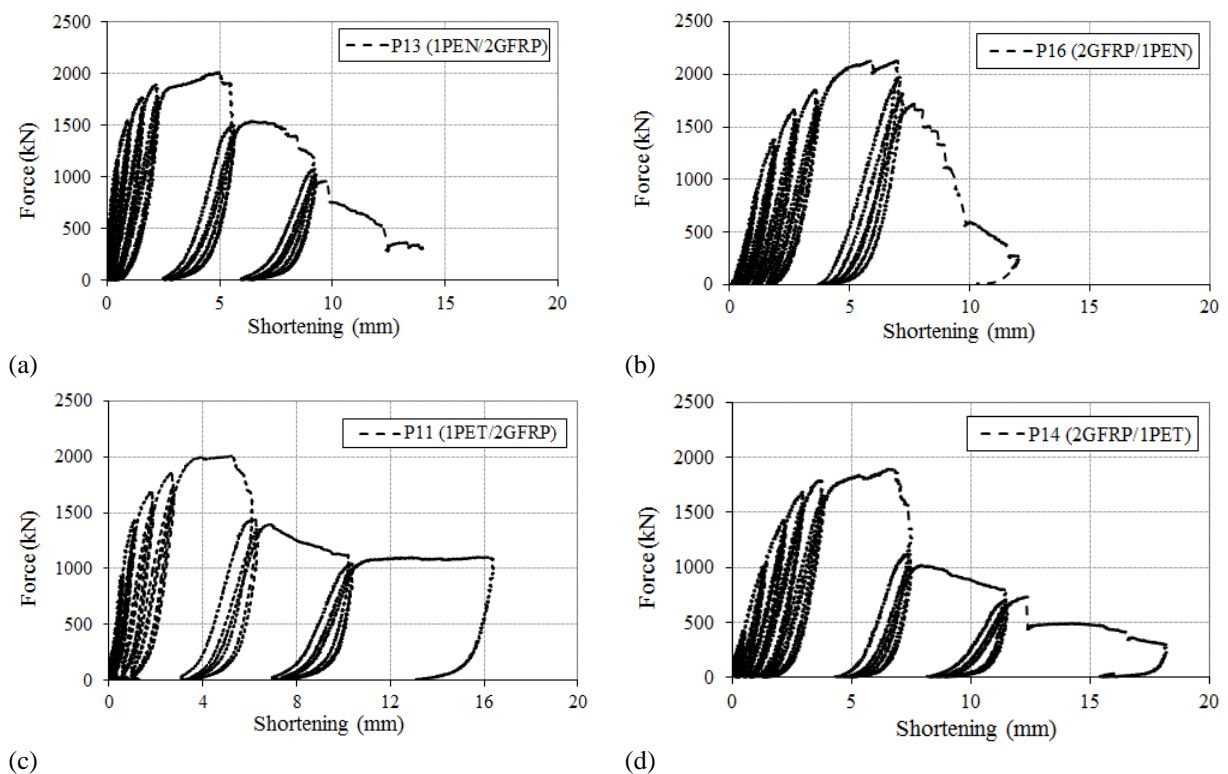

Figure 4. Load-axial shortening curves (a) P13 (1PEN-2GFRP (in/out)); (b) P16 (2GFRP-1PEN (in/out)); (c) P11 (1PET-2GFRP (in/out)); (d) P14 (2GFRP-1PET (in/out)).

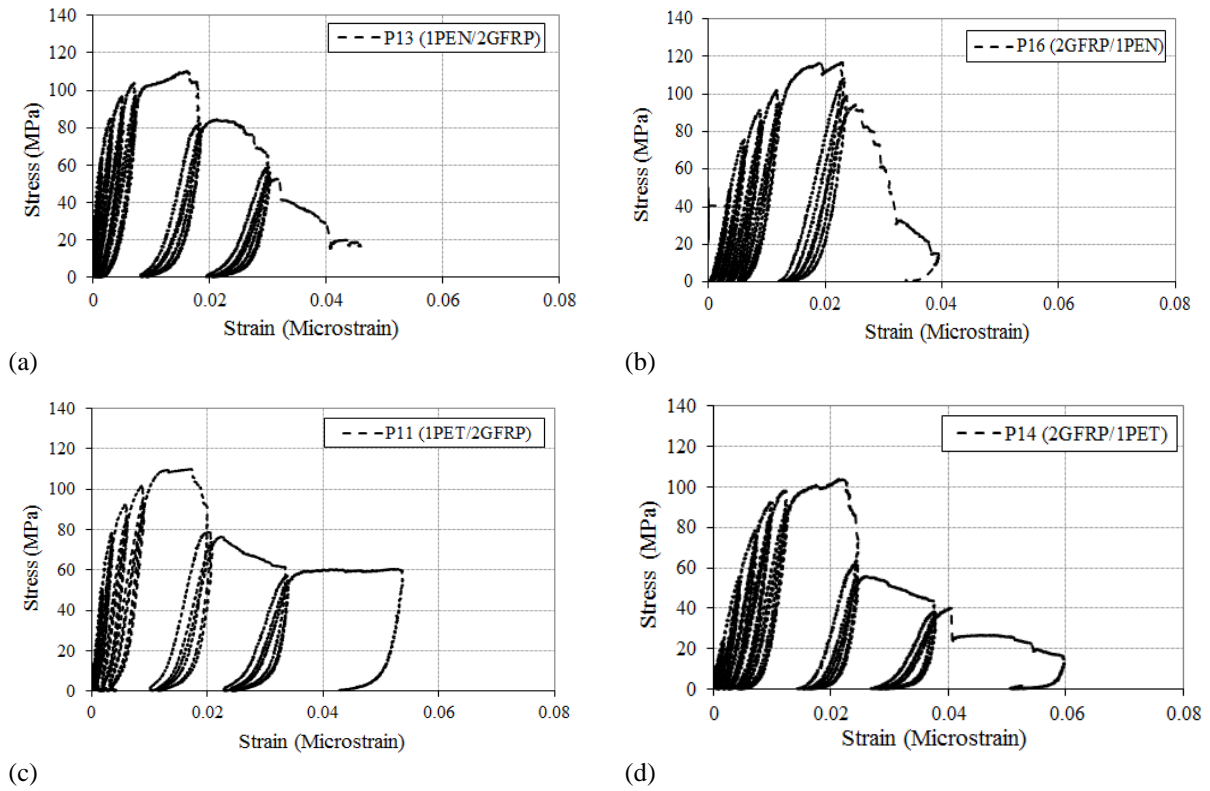

Figure 5. Stress via strain curves (a) P13 (1PEN-2GFRP (in/out)); (b) P16 (2GFRP-1PEN (in/out)); (c) P11 (1PET-2GFRP (in/out)); (d) P14 (2GFRP-1PET (in/out)).

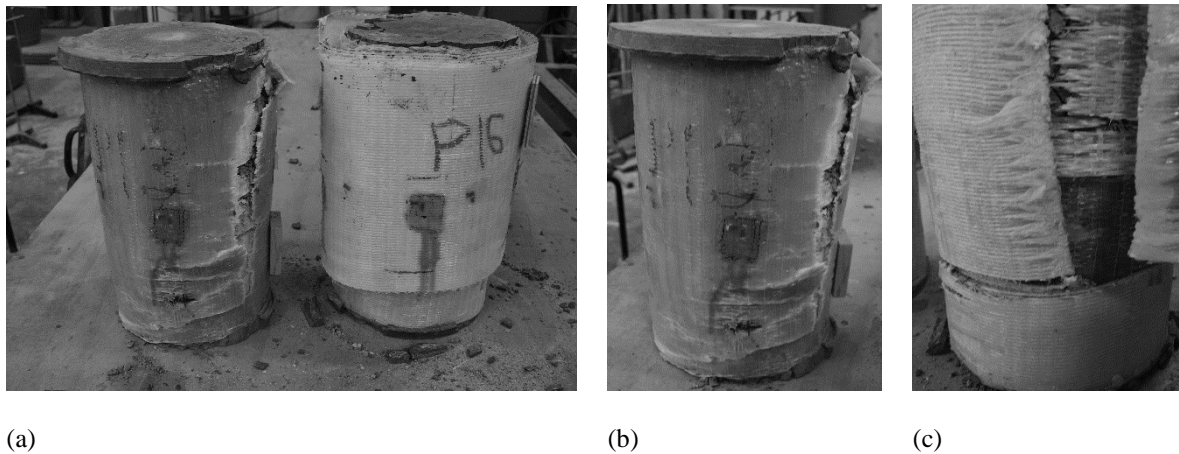

Figure 6. Failure mode of concrete-filled LRS-FRP tubes (a) P13 and P16; (b) P13 (1PEN-2GFRP (in/out)); (c) P16 (2GFRP-1PEN (in/out)).

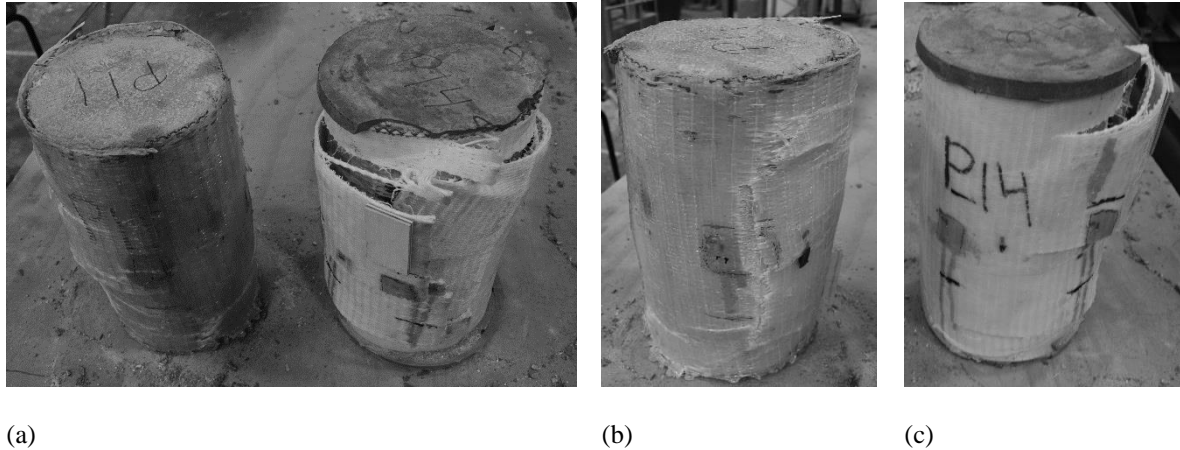

Figure 7. Failure mode of concrete filled LRS-FRP tubes (a) P11 and P14; (b) P11 (1PET-2GFRP (in/out)); (c) P14 (2GFRP-1PET (in/out)).

Placing LRS FRP inside and GFRP outside improved the performance of such CFFT in terms of strength and ductility. The reason for this was the difference between rupture strain values. When LRS FRP was placed inside, the outer GFRP was controlled by LRS FRP and rupture occurred at higher hoop strain. However, when GFRP was placed inside, it ruptured before LRS FRP because of lower rupture strain. Hence, LRS FRP was controlled by GFRP, which is ruptured at lower strain [Figs. 6 (a) and 7 (a)].

Failure was due to rupture of FRP in the overlapping area. The cause could have been improper epoxy bond or overlapping length. However, the rupture of conventional FRP occurred very suddenly and with a loud noise because of the linear elastic tensile stress-strain behavior of the FRP. Failure in CFFTs with PET and PEN FRP jackets was also found to be hoop tensile of the FRP jacket, but it was with very limited noise. LRS-FRP rupture was found to occur locally in the mid-height of FRPs instead of over a large area as in the case of conventional FRP, which explains the noise difference between LRS-FRP and conventional FRP [Figs. 6 (c) and 7 (c)].

For the hybrid FRP system, when LRS FRP was inside and GFRP was outside, failure was caused by FRP rupture. However, when LRS FRP was outside and GFRP was inside, failure was caused by overlapping layer slippage (Figs. 6 and 7).

CONCLUSION

In this paper, an experimental study was investigated to explain the cyclic compressive behavior of concrete confined with a new hybrid FRP system. LRS FRP inside and GFRP outside is effective in terms of strength and increases ultimate axial strain. Between PET and PEN FRP, PET FRP has better performance in terms of axial strain. The failure occurred because of slippage in overlapping zones. To prevent slippage, research on the overlapping zone length and on the epoxy resin for bonding is required.

In conclusion, the new hybrid LRS FRP and GFRP is a promising system for improved durability and strength; however, more research is required to study other characteristics fire resistance and energy dissipation. The system's behavior with a different number of layers of FRPs can also be investigated.

REFERENCES

- Youssf, O., ElGawady, M. A., Millsa, J. E., Ma, X., 2014. "Finite element modelling and dilation of FRP-confined concrete columns" *Engineering Structures*, 79 (15), 70-85.
- Abdelkarim, O., and ElGawady, M., A., 2015 (a) "Analytical and finite-element modeling of FRP-concrete-steel double-skin tubular columns" *J. Bridge Engineering*, ASCE, 20(8), B4014005.
- Youssf, O., ElGawady, M. A., Mills, J., 2015. "Displacement and plastic hinge length of for FRP-confined circular reinforced concrete columns" *Engineering Structures*, 101, 456:476.
- Moustafa, A. and ElGawady, M., A., 2016. "Strain rate effect on properties of rubberized concrete confined with glass fiber-reinforced polymers", *J. Composites for Construction*, ASCE, 20(5), 04016014-1:13
- Abdelkarim, O., and ElGawady, M., A., 2016. "Performance of hollow-core FRP-concrete steel bridge columns subjected to vehicle collision" *Engineering Structures*, Vol. 123, 517-531.
- Dai, J.-G.; Bai, Y.-L.; Teng, J. Behavior and modeling of concrete confined with FRP composites of large deformability. *J. Compos. Constr.* 2011, 15, 963–973
- Anggawidjaja, D.; Ueda, T.; Dai, J.; Nakai, H. Deformation capacity of rc piers wrapped by new fiber-reinforced polymer with large fracture strain. *Cem. Concr. Compos.* 2006, 28, 914– 927.
- Dai, J. G., and Bai, Y. L. (2014). "Large rupture strain (LRS) fibre reinforced polymer (FRP) composites for seismic retrofit of reinforced concrete (RC) piers." *Advanced composites in bridge construction and repair*, Woodhead, Cambridge, U.K., 117–139.
- Moon, J.; Lehman, D.E.; Roeder, C.W.; Lee, H.-E. Strength of circular concrete-filled tubes with and without internal reinforcement under combined loading. *J. Struct. Eng.* 2012, 139, doi:10.1061/(ASCE)ST.1943-541X.0000788.
- Omar I. Abdelkarim and Mohamed A. ElGawady. "Concrete-Filled-Large Deformable FRP Tubular Columns under Axial Compressive Loading." *Fibers* 2015, 3, 432-449; doi:10.3390/fib3040432.
- Carter, J. D., O. I. Abdelkarim, M. A. ElGawady, and K. H. Khayat. "FRP Confinement of High Strength Self-Consolidating Concrete." In 10th US National Conf. on Earthquake Engineering, Alaska, USA. 2014.