

01 Apr 2007

Adaptive Power System Stabilizers Using Artificial Immune System

Ganesh K. Venayagamoorthy
Missouri University of Science and Technology

Mani Hunjan

Follow this and additional works at: https://scholarsmine.mst.edu/ele_comeng_facwork

 Part of the [Electrical and Computer Engineering Commons](#)

Recommended Citation

G. K. Venayagamoorthy and M. Hunjan, "Adaptive Power System Stabilizers Using Artificial Immune System," *Proceedings of the IEEE Symposium on Artificial Life, 2007*, Institute of Electrical and Electronics Engineers (IEEE), Apr 2007.

The definitive version is available at <https://doi.org/10.1109/ALIFE.2007.367828>

This Article - Conference proceedings is brought to you for free and open access by Scholars' Mine. It has been accepted for inclusion in Electrical and Computer Engineering Faculty Research & Creative Works by an authorized administrator of Scholars' Mine. This work is protected by U. S. Copyright Law. Unauthorized use including reproduction for redistribution requires the permission of the copyright holder. For more information, please contact scholarsmine@mst.edu.

Adaptive Power System Stabilizers Using Artificial Immune System

Mani Hunjan, *Student Member, IEEE*, and Ganesh K. Venayagamoorthy, *Senior Member, IEEE*
Real-Time Power and Intelligent Systems (RTPIS) Laboratory,
Department of Electrical and Computer Engineering,
University of Missouri – Rolla, 1870 Miner Circle,
Rolla, Missouri 65409.
mhtx9@umr.edu & gkumar@ieee.org

Abstract—Power System Stabilizers (PSSs) are used to damp intra-area and inter-area oscillations in a power network. They provide effective supplementary control by supplying auxiliary control signals to the excitation system of the generators. The proper tuning of PSSs has a significant influence on its effectiveness in providing the required damping under different operating conditions and disturbances. Various algorithms have been successfully implemented to simultaneously design multiple optimal PSSs in power systems. As the power network's operating conditions change, the performance of PSSs degrade. Optimal PSS parameters obtained using Bacteria Foraging Algorithm (BFA) have shown to successfully damp out system oscillations during disturbances for various operating conditions. This paper presents an artificial immune system based PSS design to adapt the optimal parameters of the PSSs. The innate immunity to system oscillations is provided by the optimal PSS parameters while the adaptive immunity is provided by adapting the PSS parameters during transients. The effectiveness of the 'adaptive' optimal PSSs (APSSs) is evaluated on the two-area four-machine benchmark power system.

Index Terms— adaptive power system stabilizer, artificial immune system, multi-machine power system, small population based particle swarm optimization (SPPSO).

I. INTRODUCTION

POWER system stabilizers (PSS) aid in the damping of power system oscillations by modulating the excitation applied to the generator. PSSs improve the damping of generator electromechanical oscillations. The PSSs provide auxiliary stabilizing signals in addition to the terminal voltage deviation signal to control the field voltage of the excitation system. They contribute towards effective voltage control and enhancement of system stability by rapidly responding to disturbances so as to enhance the transient stability and modulating the excitation supplied to the generator to enhance the small signal stability. PSSs have been widely used to increase the damping ratios of electromechanical modes to suppress low frequency oscillations and increase the stability of the system. Depending on their location in the system, some generators participate in only one oscillation mode, while others participate in more than one mode.

Recently, several methods have been used to design and tune the parameters of the PSS in order to obtain the optimal dynamic stability characteristics [1]-[4]. The optimal PSS parameters for the four PSSs in the two-area benchmark system obtained using bacteria foraging algorithm (BFA) are shown to successfully damp out system oscillations during small and large disturbances [4]. Simultaneous tuning of the PSSs using BFA makes the PSS design less prone to premature convergences.

In this paper, the BFA optimized PSS parameters are adapted online using an artificial immune system (AIS) approach. The AIS approach is evaluated on the IEEE two-area four-machine benchmark power system. The immune feedback concept takes into consideration the deviation in generator speed from the nominal value and adapts the parameters of the PSSs accordingly. The rest of the paper is organized as follows: Section II presents the multi-machine power system considered in this paper; Section III describes briefly the biological immune system; Section IV discusses the design and structure of the 'adaptive' power system stabilizer (APSS) using AIS; Section V presents some simulation results comparing the performance of the fixed optimal parameters based PSSs and the APSSs. Finally, the conclusions are given in Section VI.

II. TWO-AREA MULTI-MACHINE POWER SYSTEM

The AIS based APSS is tested on the IEEE two-area benchmark system. The two-area power system is simulated in the PSCAD/EMTDC environment. In spite of being a small test system, the two-area power system very closely mimics the behavior of typical systems in actual operation and is useful to study inter area oscillations, like those seen in large interconnected power systems [5]. The two area power system shown in Fig. 1, consists of two fully symmetrical areas linked together by two transmission lines. Each area is equipped with two identical synchronous generators rated 20kV/900 MVA. All generators are equipped with identical speed governors and turbines, exciters and AVRs. All the four generators in Fig. 1 are also equipped with the PSSs, shown in Fig. 2. The loads are represented as constant impedances and split between the areas in such a way that Area 1 is exporting about 413 MW of power to Area 2. Three

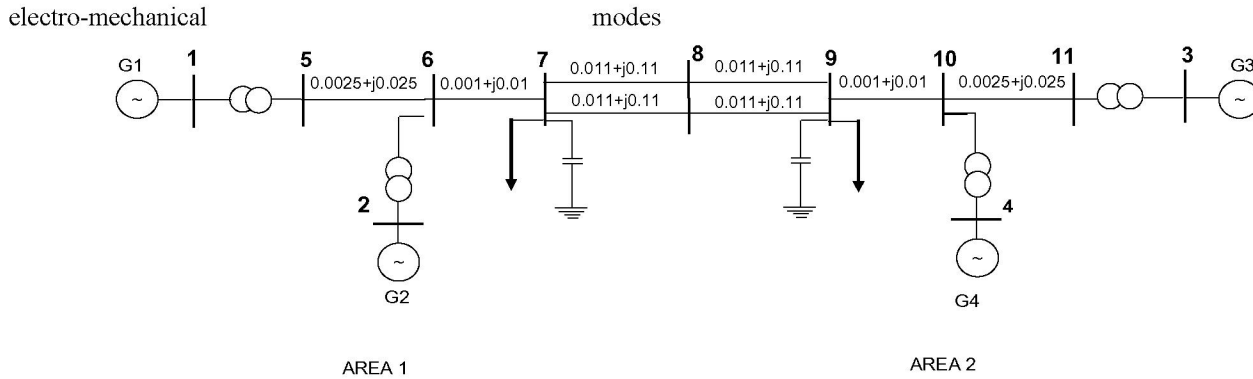

Fig. 1. Two-area four machine power system.

of oscillation are present in this two area system; two inter-plant modes, one in each area, and one inter-area low frequency mode, in which the generating units in one area oscillate against those in the other area.

The PSSs detect the variation in the rotor speed ($\Delta\omega_{Gn}$), and provide an additional input signal (V_{pss}) to the excitation system of the generator to reduce the power swings in the system rapidly. A typical PSS block diagram is shown in Fig. 2. It consists of an amplifier block of gain constant K , a block having a washout time constant T_W and two lead-lag compensators with time constants T_1 to T_4 . The optimal value of the gain and the four time constants are determined using the BFA [4]. These parameters are adapted online according to variations in generator speed, using the AIS, explained in Section IV of this paper.

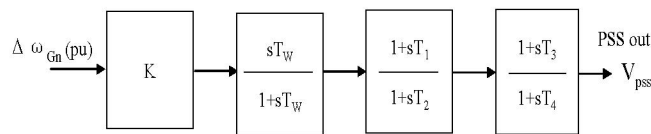

Fig. 2. Block diagram of a power system stabilizer.

III. BIOLOGICAL IMMUNE SYSTEM

The artificial immune system is a biologically motivated information processing system. It is a parallel and distributed adaptive system which can learn new information, recall previously learned information and perform pattern recognition tasks in a decentralized fashion. Its learning takes place by evolutionary processes. The main role of the immune system (IS) is to recognize all cells within the body and categorize them as self or non-self. The non-self cells are further categorized in order to induce an appropriate type of defense mechanism. The non-self cells are the antigens. Antigens are foreign substances like bacteria and viruses which activates an immune response. The powerful information processing capabilities of the IS, such as feature extraction, pattern recognition, learning, memory and its distributive nature provide metaphors for its artificial

counterpart.

The natural immune function of the human body is realized by the interplay of various cells in the body. Among these cells, the T and B cells play the most important roles. T and B cells are produced in the thymus gland and the bone marrow respectively. B-cells can secrete antibodies and can perform the nonspecific humoral immunity. Antibodies are proteins used by the immune system to neutralize antigens. T cells constitute the helper T cells, the suppressor T cells and the killer T cells. The function of the T cells is to adjust the immune process and remove antigens. For adjustment, the T cells improve and enhance the immune response on appearance of an antigen, and inhibit the reproduction of immune cells to restore dynamic balance of the system once the number of antigen falls below a certain limit. Killer T cells secrete cytotoxin to kill antigens and perform specific cell-mediated immunity.

The IS exhibits two types of responses: T-cell mediated cell immune response and B-cell mediated humoral immune response. For humoral immune response the antigen presenting cells (APC) captures the antigen and activates CD4+T cells which clone and differentiate into the TS (suppressor) and TH (helper) cells [6]. APC are highly specialized cells that can process antigens and present them for T cell activation. The TH cells activate the B cells which capture the antigen. The B cells are activated both by the antigen itself and T cells. TS cells suppress the action of TH cells at later stage. For cell immune response, the APC stimulates the action of the killer T cells. The killer T cells are also activated by both the antigen and other T cells. The activated killer T cells interact with interleukine (IL2 with IL-2R) and finally proliferate and differentiate into the effect T cells or antibodies [6]. Fig. 3 depicts the IS with the two types of immune responses. The memory cells are used to remember and store the response to a particular antigen for later use.

Within the IS there is a feedback mechanism which simultaneously performs two diverse tasks: rapidly responding to the presence of foreign material while quickly stabilizing the immune system. This feedback mechanism

involves cooperation between the inhibitive mechanism (TS cells) and the main feedback mechanism. After the foreign matter is digested by the APC, they transfer the information about the antigen to helper T cells, activating them. The helper T cells then stimulate the B cells, the killer T cells and the suppressor T cells. The activation of B cells in response to antigens is considered to be the main feedback mechanism of the IS and is responsible for the elimination of the antigens. The helper T cells and the foreign materials activate the suppressor T cells (when number of antigens is reduced), and the suppressor T cells inhibit the activities of all other cells. As a result the reaction of the IS is tranquilized. This is the inhibitive mechanism [6]. For the design of the adaptive PSS presented in this paper, only the B cell mediated humoral immune response is taken into consideration and the feedback mechanism is applied to this B cell mediated response.

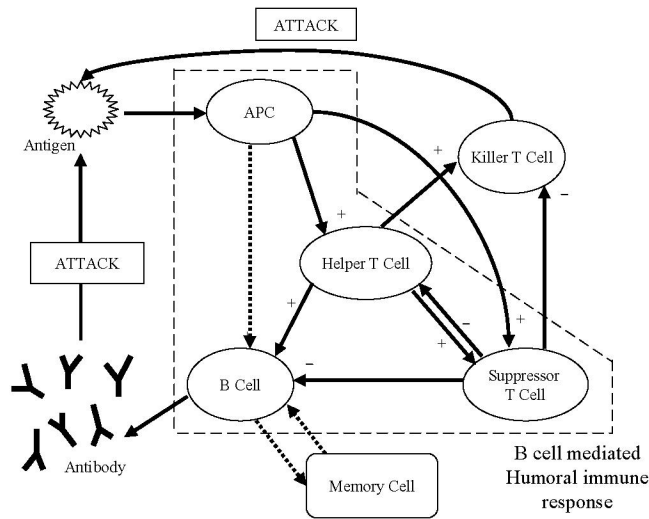

Fig. 3. Schematic of the Immune System.

IV. ADAPTIVE PSS DESIGN

The innate immunity to system oscillations is provided by the optimal PSS parameters while the adaptive immunity is provided by adapting the PSS parameters. The optimal values of the gain (K) and the lead-lag compensator time constants (T_1 , T_2 , T_3 , and T_4) of the four PSSs for the power system in Fig. 1. are found using the BFA algorithm. These optimal parameters damp the speed oscillations substantially during small and large disturbances [4] and are used as the 'reference' PSSs for the power system. The optimal parameters of the PSSs (reference PSSs) are adapted online during transients, thus referred to as the APSSs. This design of these APSSs using the AIS approach is explained below.

The amount of foreign materials (antigens) at k^{th} generation can be defined as $Ag(k)$, which in this study is the generator rotor speed deviations, $\Delta\omega_{Gn}(k)$. The output from the helper T-cells stimulated by the antigen is given by

$$TH(k) = m \Delta\omega_{Gn}(k) \quad (1)$$

where m is a stimulation factor whose sign is positive. The suppressor T-cells inhibit other cell activities and their effect on B-cells can be given by

$$TS(k) = m' f\left(\frac{\Delta\omega_{Gn}(k)}{\Delta\omega_{Gn}(k-1)}\right) \Delta\omega_{Gn}(k) \quad (2)$$

where m' is a positive suppression factor. $f(x)$ is a nonlinear function introduced to take into account the effect of the reaction between the antibody and the antigen. This function $f(x)$, can be defined as

$$f(x) = \exp(-x^2) \quad (3)$$

where the output of the function is limited within the interval $[0, 1]$, as shown in Fig. 4.

The total stimulation received by the B-cells is given by (4) and is known as the immune based feedback law. It is the difference of the stimulation it receives from the helper T-cells and the inhibition from the suppressor T-cells. These B-cells are responsible for eliminating the antigen or for reducing the speed deviations in this case.

$$B(k) = TH(k) - TS(k)$$

$$B(k) = \left[m - m' f\left(\frac{\Delta\omega_{Gn}(k)}{\Delta\omega_{Gn}(k-1)}\right) \right] \Delta\omega_{Gn}(k) \quad (4)$$

Thus, as can be seen in (4), the amount of antibodies generated for the removal of antigens is a nonlinear function of the antigens present in the system.

The APSS design proposed based on this immune feedback law is depicted in Fig. 4. The antigen for the adaptive PSS is the difference of the desired value of rotor speed and the actual value of rotor speed being obtained i.e. the speed deviations $\Delta\omega_{Gn}$. The APC recognizes the antigen and initiates antibody production. Once the antigen is recognized, it is analyzed and solution to eliminate the antigen is found. The TH cells work to eliminate the antigen, while the TS cells work (after a one step time delay) to inhibit the activities of other cells and tranquilize the reaction of the immune system.

For the five PSS parameters (K , T_1 , T_2 , T_3 , and T_4) shown in Fig. 4, the parameter $m = [m_1, m_3, m_5, m_7, m_9]$ controls the overshoot response and $m' = [m_2, m_4, m_6, m_8, m_{10}]$ and function $f(x)$ control settling time response. The parameters K , T_1 , T_2 , T_3 , and T_4 are the optimal PSS parameters obtained using BFA. The performance of the immune feedback law greatly depends on how these factors are selected. As can be seen the total gain factor is adjusted at any moment according to immune effect and the response also greatly depends on the number of antigens (or speed deviation in the system). That is, the immune feedback mechanism is adaptively adjusted according to the dynamically changing environment,

while the detailed model and information of the outside environment is not needed for the operation of the immune system.

The PSS parameters (K , T_1 , T_2 , T_3 , and T_4) require five sets

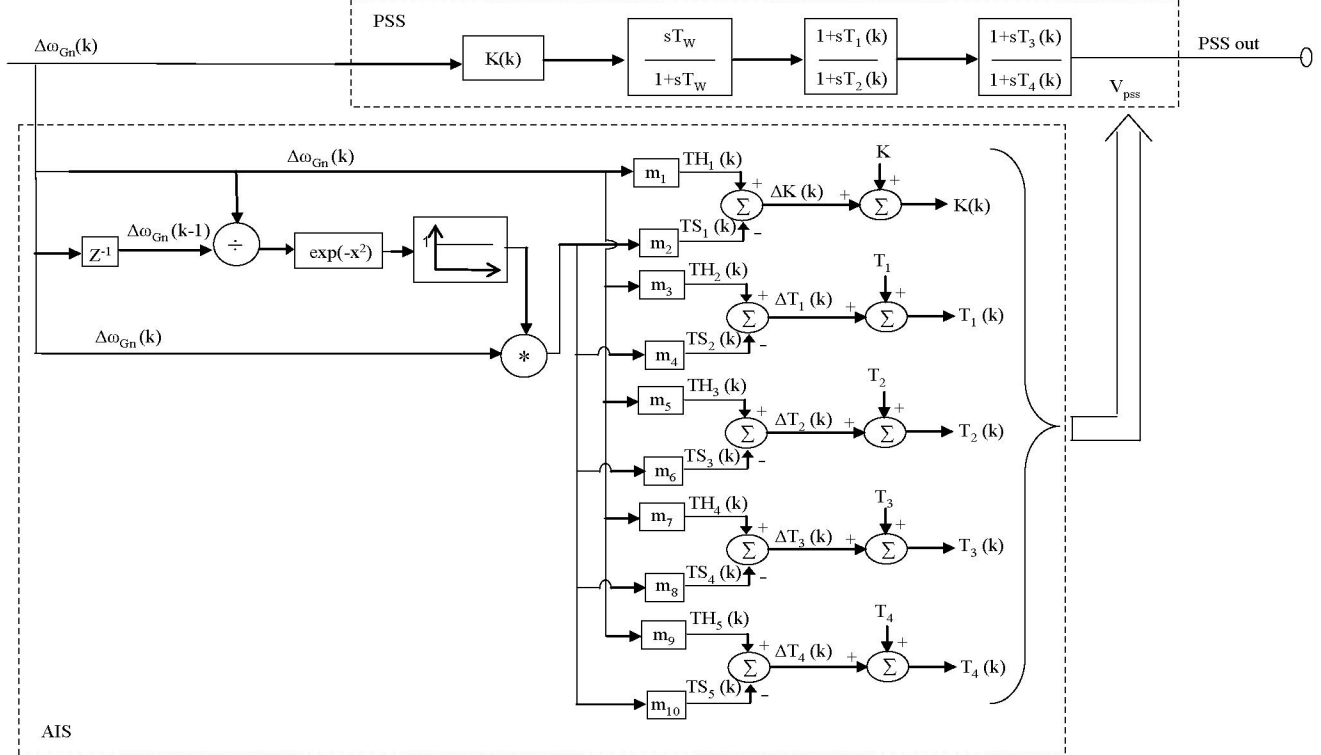

Fig. 4. Adaptive PSS structure

of equations to adapt them. Hence, ten parameters m_1 to m_{10} are required for one PSS and are determined offline using the Small Population based Particle Swarm Optimization (SPPSO) algorithm. Therefore, four PSSs used require 40 parameters (m_1 to m_{40}). SPPSO is a variant of Particle Swarm Optimization (PSO) [7, 8], introduced by one of the authors [9]. SPPSO is a small population based fast optimization tool. The swarm initially has a population of random solutions. Each potential solution, called *particle*, is given a random velocity and is flown through the problem space. The particles have memory and each particle keeps track of previous best position and corresponding fitness. The previous best value is called the *pbest* of the particle and represented as p_{id} . Thus, p_{id} is related only to a particular particle i . The best value of all the particles' *pbests* in the swarm is called the *gbest* and is represented as p_{gd} . The basic concept of PSO technique lies in accelerating each particle towards its p_{id} and the p_{gd} locations at each time step. The amount of acceleration with respect to both p_{id} and p_{gd} locations is given random weighting

$$x_{id} = \left\{ \begin{array}{l} w \times v_{id} + c_1 \times rand_1 \times (p_{id} - x_{id}) \\ + c_2 \times rand_2 \times (p_{gd} - x_{id}) \end{array} \right\} + x_{id} \quad (5)$$

The new position of the particle is computed using (5) where x_{id} represent the position of i^{th} particle in d^{th} dimension and, $rand_1$ and $rand_2$ are two uniform random functions. v_{id} represent the velocity of i^{th} particle in d^{th} dimension. w is called the inertia weight, which controls the exploration and exploitation of the search space.

The concept of PSO with regeneration is incorporated to make the convergence faster like it would be with a large population of PSO. This concept of regeneration is introduced in SPPSO, where new particles are randomly created every N iterations to replace all but the *gbest* particle in the swarm. In the addition to keeping the *gbest's* particle parameters, the population *pbest* attributes are also saved from one set of population to the next every N iterations.

The objective function for determining m_1 to m_{10} is the integrated transient response area of the speed deviation of a generator. The PSS improves system damping and in turn minimizes the cost function. Since in a power system there are several generators, this becomes a multi-objective function given by (6).

$$J = \sum_{n=1}^N \sum_{Gn}^k J_{Gn} \quad (6)$$

where

$$J_{Gn} = \sum_{j=1}^{NP} \sum_{t=T_0}^{t_2/\Delta t} (\Delta\omega_{Gn}(t) \times (A \times (t - t_0))) \times \Delta t \quad (7)$$

where NP is the number of operating points for which optimization is carried out, N is the number of faults for which the optimization is carried out, A is the weighing factor, k is the number of generators in the system, $\Delta\omega_{Gn}$ is the speed deviation of generator G_n , t_0 is the time the fault is cleared, T_0 and t_2 are the start and end time instants respectively considered for the transient area calculation, Δt is the speed signal sampling period, t is the simulation time in seconds. The optimization is carried by subjecting the power system to a large disturbance. In this study, a 200ms three phase short circuit is applied at the middle of the tie lines for the two areas of the power system.

The flowchart in Fig. 5 illustrates the design and operation phases of the APSS. Stage one involves

determining the optimal parameters of the four PSSs using BFA algorithm [4]. The second stage uses these optimal PSS parameters and determines the optimal values of m ($m_1, m_3...m_9$) and m' ($m_2, m_4...m_{10}$) for application of the immune feedback law given in (4). Since there are four PSSs in the power system the optimal values of m_1 to m_{40} is determined. The SPPSO algorithm feeds values of the m 's to the 2 area power system and the cost function (integrated transient response area of the speed deviation) obtained from the system is then fed back to the SPPSO algorithm. These first two stages involve the designing of the APSS. Once the design phase is complete and all the optimal parameters of the PSSs and AIS are obtained, the operation phase uses these parameters to adapt the PSSs of the four generators.

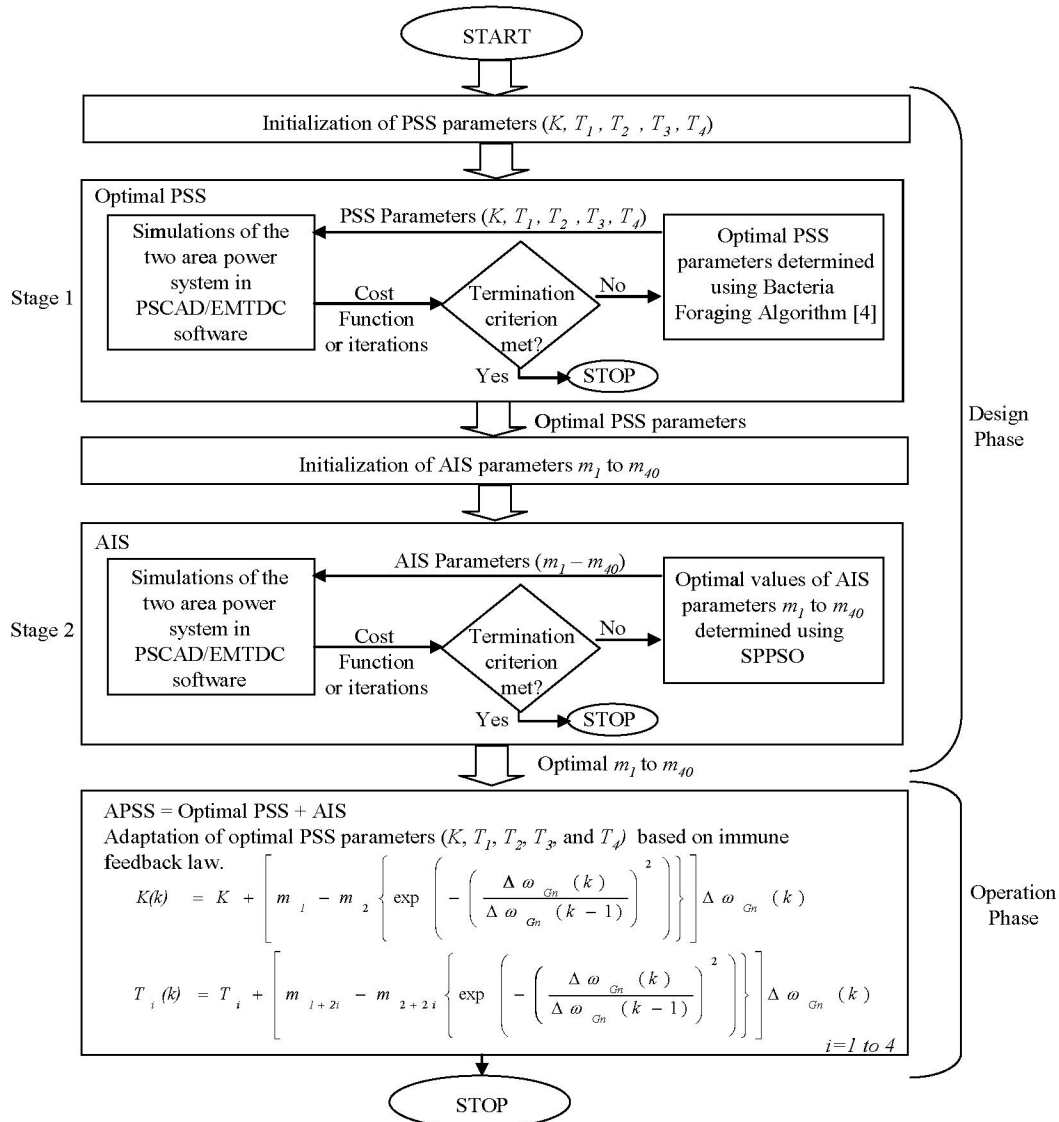

Fig. 5. Flowchart illustrating the design and operation phases of the APSS.

V. SIMULATION RESULTS

The effectiveness of the adaptive PSS is evaluated for the IEEE two-area multi-machine system. The simulation of the two-area system power system is carried out in PSCAD/EMTDC environment [10], and the AIS and the SPPSO algorithms are implemented in FORTRAN.

The BFA optimized parameters are adapted for the four PSSs, using the immune feedback law given in (4). The BFA optimized parameters give robust damping performance for various operating conditions and disturbances [4]. The value of the BFA optimized PSS parameters are given in the Appendix, Table A. 1. The BFA optimized parameters are further adapted and the values of m_1 to m_{40} for the four PSSs of the two area system are determined using the SPPSO algorithm offline. The optimal values of m_1 to m_{40} obtained are given in the Appendix, Table A. 2. The minimum and maximum limits allowed for these parameters (m_1 to m_{40}) during the optimization are 0 and 10000 respectively. Two tests are carried out on the two-area multi-machine power system and the response of the fixed optimal parameter based PSSs and the APSSs are compared.

Test 1: Temporary Transmission Line Outage

A 200ms line outage is applied between buses 8 and 9 of the two area system given in Fig. 1. The speed response of generator G1 and G4 is given in Figs. 6 and 7 respectively. Though not shown, generators G2 and G3 exhibit similar responses. It can be seen that the response of APSSs are similar to that of the fixed optimal parameters based PSSs. The deviations in speed for such faults are too small to cause any changes in the response due to the immune feedback mechanism. The optimal parameters of the PSSs provide the innate immunity for ‘small’ disturbances and oscillations (small speed deviations) in the generator speed.

Test 2: Three Phase Short Circuit

A severe disturbance is now applied to evaluate the performances of the two PSSs designs. A three phase short circuit of duration 200ms is applied at bus 8 in Fig. 1. The rotor speed responses of the four generators in the system - G1, G2, G3 and G4, are shown in Figs. 8 to 11 respectively. The immune feedback response adapts the PSS parameters to minimize the settling time and the overshoot in the speed response of each of the generators in the power system. It is seen that the response for adaptive optimal PSS parameters is better than that obtained with the fixed optimal PSS parameters. Thus, for different operating conditions the adaptation of parameters can improve the damping and minimize the oscillations in the system.

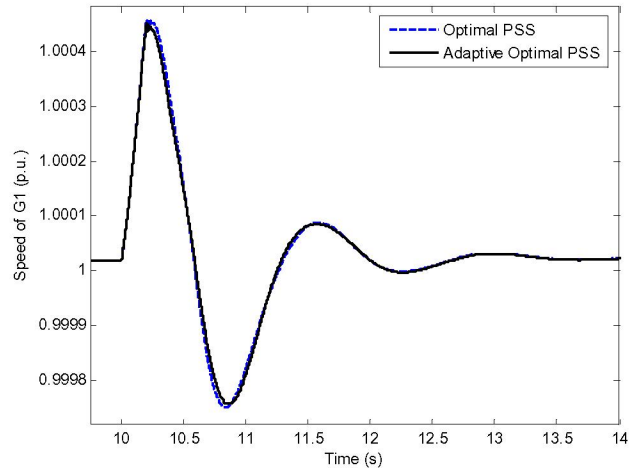

Fig. 6. Speed response of generator G1 for a 200ms line outage between buses 8 and 9.

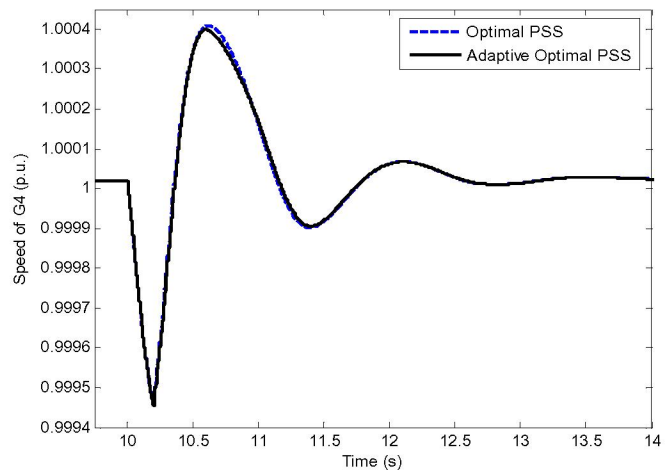

Fig. 7. Speed response of generator G4 for a 200ms line outage between buses 8 and 9.

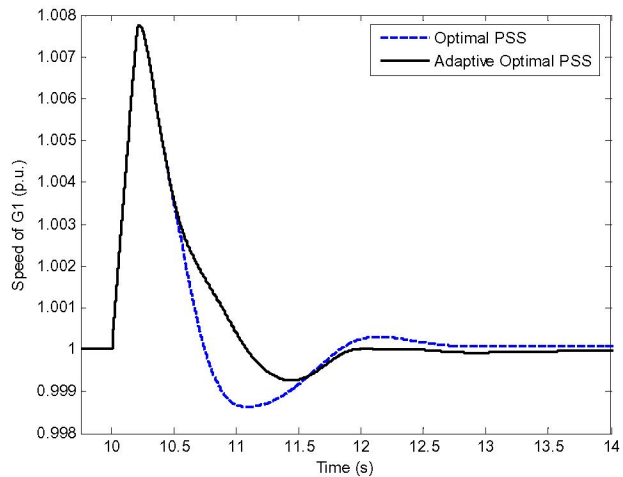

Fig. 8. Speed response of generator G1 for a 200ms short circuit applied at bus 8.

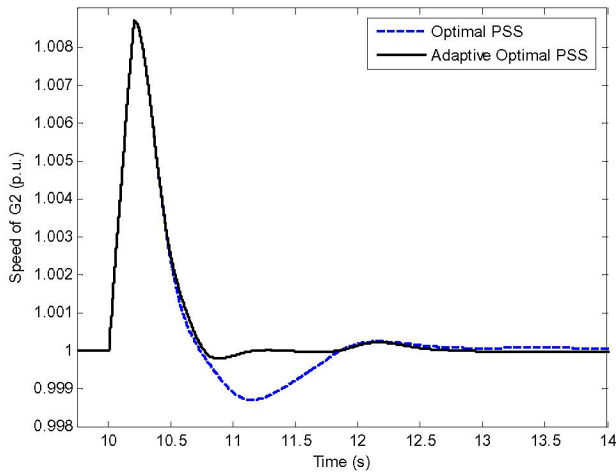

Fig. 9. Speed response of generator G2 for a 200ms short circuit applied at bus 8.

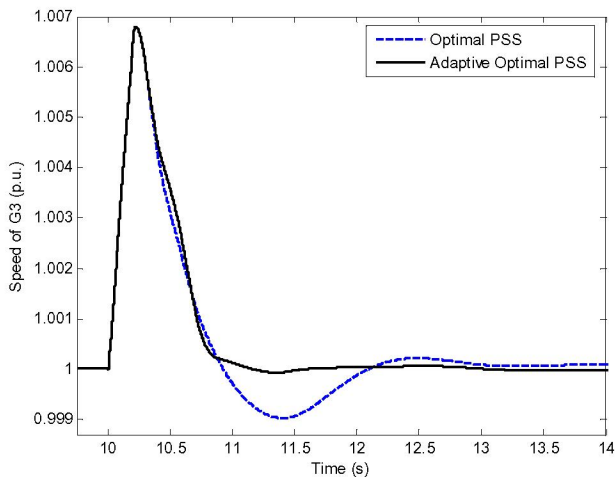

Fig. 10. Speed response of generator G3 for a 200ms short circuit applied at bus 8.

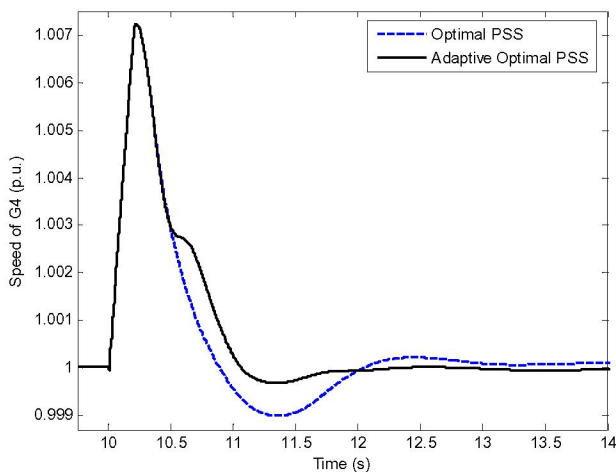
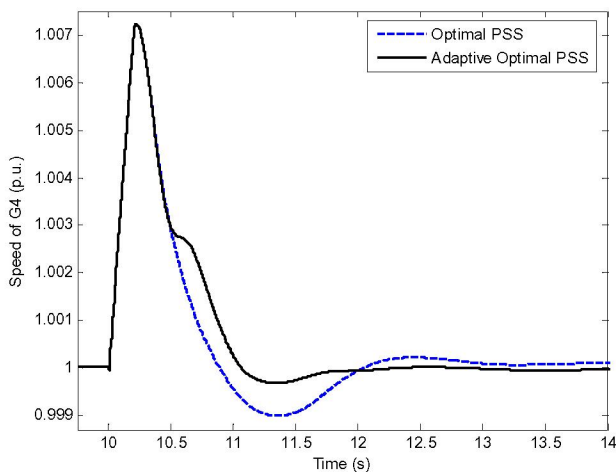

Fig. 11. Speed response of generator G4 for a 200ms short circuit applied at bus 8.



VI. CONCLUSION

The successful implementation of an immune feedback mechanism based adaptation of power system stabilizer (PSS) parameters has been presented in this paper. The innate immunity to power system oscillations is provided by the optimal PSS parameters while the adaptive immunity is provided by adapting the optimal PSS parameters. The optimal parameters of the PSSs are obtained using the bacteria foraging algorithm prior to adaptation by the artificial immune system. The adaptation of PSS parameters improved the response of the PSSs in the two area power system especially during short circuit disturbances. The parameters of the PSS vary according to the disturbance faced by the system to quickly eradicate the disturbance and stabilize the system at the same time. This paper has shown that it is possible to a design PSS based on a linearized power system model and use adaptive immune feedback law to improve PSS performance as system conditions change over time.

VII. REFERENCES

- [1] F. Rashidi, and M. Rashidi, "Tuning of power system stabilizers via genetic algorithm for stabilization of power systems," in *17th Int. Conf. on Innovations in Applied Artificial Intelligence*, pp. 1210-1219, May 17-20, 2004.
- [2] M. A. Abido, "Optimal design of power system stabilizers using particle swarm optimization," in *IEEE Trans. On Energy Conversion*, vol. 17, issue 3, pp. 406-413, Sept. 2002.
- [3] Y. Hsu, and C. Chen, "Tuning of power system stabilizers using an artificial neural network," in *IEEE Trans. On Energy Conversion*, vol. 6, issue 4, pp. 612-619, Dec 1991.
- [4] T. K. Das, and G. K. Venayagamoorthy, "Bio-Inspired Algorithms for the Design of Multiple Optimal Power System Stabilizers: SPPSO and BFA", in *Conf. of Industrial Application Society*, Oct 7-12, 2006.
- [5] M. Klein, G. J. Rogers, and P. Kundur, "A fundamental study of inter area oscillations in power system," *IEEE Trans. on Power Systems*, vol. 6, no. 3, pp. 914-921, August 1991.
- [6] C. A. Janeway, P. Travers, M. Walport, and M. J. Shlomchik, *Immunobiology*, Garland Science, 6th edition, 2005, ISBN 0-8153-4101-6.
- [7] J. Kennedy and R. Eberhart, "Particle Swarm Optimization," in *Proc. 1995 IEEE Conf on Neural Networks*, vol. 4, pp. 1942-1948.
- [8] Y. Shi and R. Eberhart, "Empirical study of particle swarm optimization", in *Proc. of the 1999 Congress on Evolutionary Computation*, CEC 99, vol. 3, 1999.
- [9] T. K. Das, and G. K. Venayagamoorthy, "Optimal Design of Power System Stabilizers Using a Small Population Based PSO," *IEEE Power Engineering Society General Meeting*, pp. 1-7, 18-22 June 2006.
- [10] Manitoba HVDC Research Centre Inc, *PSCAD/EMTDC user's guide*, version 3.0, 244 Cree Crescent, Winnipeg, Manitoba, Canada R3J 3W1.

APPENDIX

TABLE A.1.

TWO AREA POWER SYSTEM BFA OPTIMIZED PSS PARAMETERS

Generator	BFA optimized parameters
G1	$K = 30.0, T_1 = 0.50,$ $T_2 = 0.50, T_3 = 10.0, T_4 = 13.61$
G2	$K = 30.0, T_1 = 0.50,$ $T_2 = 0.50, T_3 = 10.0, T_4 = 13.50$
G3	$K = 30.0, T_1 = 0.50,$ $T_2 = 0.50, T_3 = 10.0, T_4 = 13.70$
G4	$K = 29.88, T_1 = 0.50,$ $T_2 = 0.50, T_3 = 10.0, T_4 = 15.0$

TABLE A.2.

VALUES OF m_j TO m_{40} FOR BFA OPTIMIZED PARAMETERS

Generator	m_1 to m_{40} for the generators
G1	$m_1 = 1471.65, m_2 = 0.0, m_3 = 0.0, m_4 = 1405.94,$ $m_5 = 0.0, m_6 = 0.0, m_7 = 54.38, m_8 = 0.0, m_9 = 0.0,$ $m_{10} = 0.0$
G2	$m_{11} = 457.87, m_{12} = 1884.69, m_{13} = 0.0, m_{14} = 164.35,$ $m_{15} = 0.0, m_{16} = 0.0, m_{17} = 130.45, m_{18} = 0.0, m_{19} = 0.0,$ $m_{20} = 50.83$
G3	$m_{21} = 0.0, m_{22} = 691.44, m_{23} = 0.0, m_{24} = 134.83,$ $m_{25} = 0.0, m_{26} = 0.0, m_{27} = 1701.47, m_{28} = 0.0, m_{29} = 0.0,$ $m_{30} = 67.07$
G4	$m_{31} = 0.0, m_{32} = 10000, m_{33} = 0.0, m_{34} = 51.37,$ $m_{35} = 40.67, m_{36} = 0.0, m_{37} = 59.57, m_{38} = 0.0, m_{39} = 0.0,$ $m_{40} = 78.87$