

01 Jan 1988

## Simulation of Photovoltaic Power Systems and Their Performance Prediction

S. Rahman

Badrul H. Chowdhury

*Missouri University of Science and Technology*, [bchow@mst.edu](mailto:bchow@mst.edu)

Follow this and additional works at: [https://scholarsmine.mst.edu/ele\\_comeng\\_facwork](https://scholarsmine.mst.edu/ele_comeng_facwork)



Part of the [Electrical and Computer Engineering Commons](#)

---

### Recommended Citation

S. Rahman and B. H. Chowdhury, "Simulation of Photovoltaic Power Systems and Their Performance Prediction," *IEEE Transactions on Energy Conversion*, Institute of Electrical and Electronics Engineers (IEEE), Jan 1988.

The definitive version is available at <https://doi.org/10.1109/60.8048>

This Article - Journal is brought to you for free and open access by Scholars' Mine. It has been accepted for inclusion in Electrical and Computer Engineering Faculty Research & Creative Works by an authorized administrator of Scholars' Mine. This work is protected by U. S. Copyright Law. Unauthorized use including reproduction for redistribution requires the permission of the copyright holder. For more information, please contact [scholarsmine@mst.edu](mailto:scholarsmine@mst.edu).

SIMULATION OF PHOTOVOLTAIC POWER SYSTEMS  
AND THEIR PERFORMANCE PREDICTION

Saifur Rahman  
Senior Member

B. H. Chowdhury  
Student Member

Electrical Engineering Department  
Virginia Tech  
Blacksburg, VA 24061

ABSTRACT

The objective of this paper is two-fold. The first is to examine and test a number of photovoltaic performance analysis models for their ability to estimate the AC power output, and validate those against historical observations from a PV test facility. The second is to develop a method to estimate meteorological parameters for use in PV performance models for predicting future AC power output from a PV test site. We have examined 12 such PV performance models and extensively tested PVFORM - System Analysis Program and LCP - Lifetime Cost and Performance model. These two models are tested using (TMY) the Typical Meteorological Year and the VPI model generated estimates of long-term data. Performance prediction results are compared against actual observations at a 4-kW PV test facility in Raleigh, North Carolina. Our results show that the VPI model generated data, when used with PVFORM model, provide the best predictions for AC power output from this 4-kW PV test facility.

1.0 INTRODUCTION

The growth of photovoltaics for electric power has resulted in a proliferation of PV performance analysis models. With respect to details, these models range from first-order approximations of photovoltaic system performance to complex, circuit level representations. In general, these models take a deterministic approach for evaluating the PV performance. In other words, these models use a set of values for insolation, ambient temperature and wind speed, among other parameters, to determine the output power of PV arrays under these conditions. Such models are useful for comparing the performance of different PV arrays under a set of given conditions. However, when photovoltaic generation facilities are to be designed and built based on the best possible estimate of their performance, we require the best possible predictions of meteorological data.

Thus we present this paper with the two-fold objective of selecting the best possible PV performance analysis model(s),

87 SM 425-2      A paper recommended and approved by the IEEE Power Generation Committee of the IEEE Power Engineering Society for presentation at the IEEE/PES 1987 Summer Meeting, San Francisco, California, July 12 - 17, 1987. Manuscript submitted February 3, 1986; made available for printing April 15, 1987.

and providing a technique for predicting the necessary meteorological data from long term historical observations at the site.

At the outset we present a discussion on several PV performance analysis models that are available and have been tested for application. From a list of 12 such models two are chosen for detailed analysis and review. These are: (i) Lifetime Cost and Performance (LCP) model developed at the Jet Propulsion Laboratory and (ii) PV Performance (PVFORM) model from the Sandia National Laboratory.

The input data requirements for these models are studied and various alternative ways of providing these data are investigated. Variations in PV system performance prediction due to using measured insolation data, TMY data and the frequency distribution of long term insolation data are presented and discussed. Results of these predictions are compared against hourly performance record of a 4-kW photovoltaic test facility of the Carolina Power and Light Company located in Raleigh, North Carolina [1].

2.0 PV SYSTEM PERFORMANCE ANALYSIS MODELS

The 12 models discussed in this section are chosen because of their availability in the public domain, and discussions about them in the open literature. In fact, ten of these models have been extensively studied and evaluated at the Jet Propulsion Laboratory [2]. Names of all 12 models and their points of origin are given in Table 1.

TABLE 1. PV Performance Analysis Models

Model	Originator
PV Performance Model	EPRI
Photovoltaic F-Chart	U. of Wisconsin
Lifetime Cost & Performance	JPL
Engineering & Reliability	JPL
TRNSYS/MIT	U. of Wisconsin
	MIT Lincoln Lab
Photovoltaic Analysis Model	SERI
PVFORM - System Analysis Program	Sandia Lab
Solar Cell Model (SOLCEL-II)	Sandia Lab
Solar Energy System Analysis	Sandia Lab
TRNSYS/ASU	U. of Wisconsin
	Arizona State U.
	Sandia Lab
PV Transient Analysis Prog.	BDM Corp.
	Sandia Lab
Solar Reliability	Battelle-Columbus
	Sandia Lab

## 2.1 PV Model Categories

These models can be grouped into three categories depending on their degree of detail. These categories are: (i) simplified first-order, (ii) detailed PV system performance and (iii) special cases. This categorization has been presented in Smith and Reiter [2]. The first category includes simplified models that can be used for first-order approximations of system performance. Photovoltaic Performance Model (PVPM) and PV F-Chart would fall in this first category. These are essentially efficiency models that have been scaled up to the PV system level. These are simple codes with simple input requirements. These can be used to perform case studies relatively easily. However, the extent of design options these models can examine is limited.

Majority of the models are in the second category. These simulate the subsystems in greater detail and can be used for a variety of systems analyses. Models in this category are: (i) Lifetime Cost and Performance (LCP) model, (ii) Engineering and Reliability (E&R) model, (iii) TRNSYS/MIT, (iv) Photovoltaic Analysis Model (PVAM), (v) PVFORM-System Analysis Program, (vi) Solcel-II, (vii) Solar Energy System Analysis (Solsys) and (viii) TRNSYS/ASU. LCP, E&R, TRNSYS/MIT, PVAM and PVFORM codes are used to model aggregated arrays or modules and have been developed primarily for flat plate analysis. These models also emphasize such factors as dirt accumulation, module replacements, differences in power conditioning and atmospheric conditions. Solcel-II, Solsys and TRNSYS/ASU are cell models that were originally developed for modeling PV concentrators where thermal aspects are easily tractable at the cell level. However, when we deal with array scale models, the thermal modeling becomes increasingly difficult.

Last two models in Table 1 can be grouped in the third category. These were not specifically designed to model PV system performance. For example, PV Transient Analysis Program (PV-TAP) is a detailed subsystem network model that is intended for electrical circuit parameter analysis. It can simulate the behavior of an electrical system in detail including the transient effects. Similarly Solar Reliability (Solrel) is a reliability analysis model. It can be used with a number of performance analysis models and can incorporate failure analysis.

## 3.0 PVFORM & LCP MODELS

As one of the objectives of this paper is to study the applicability of PV system analysis models to simulate the performance of photovoltaic arrays we have chosen PVFORM and LCP computer models, from the list of 12 models, for further analysis. Reasons for this choice are the following.

A set of eight characteristics is employed to judge the suitability of a PV performance analysis model. These are given in Smith and Reiter [2] and are listed as follows.

- a. Cell characteristics
- b. Module characteristics
- c. Orientation and geometric characteristics
- d. Array level characteristics
- e. Power conditioning unit characteristics
- f. Plant level characteristics
- g. Operations & Maintenance characteristics
- h. Site-specific characteristics

Both PVFORM and LCP analysis models are able to represent all these characteristics and their source codes are available in the public domain. Moreover, their input data requirements are straightforward and both of them have been implemented on microcomputers. Brief descriptions of these models highlighting their salient features are presented in the following. Primary functions and input data requirements of these two models are given in the flowchart in figure 1. Even though these two models perform the same functions, these are accomplished differently as can be seen in references [3] and [4].

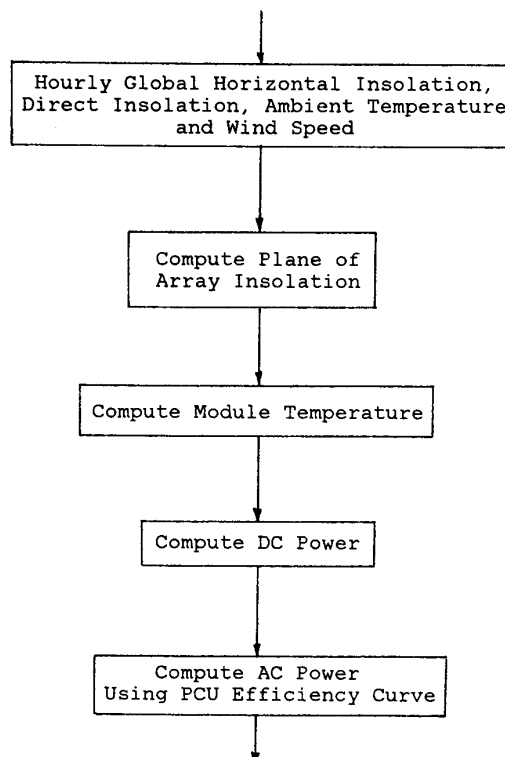

Figure 1. Functions in a PV Model

### 3.1 PVFORM - System Analysis Program

This model has been under development at the Sandia National Laboratory for some time [3]. It has been designed to simulate the hourly performance of a PV flat-plate system for a one year period. The code is based on simple, but relatively accurate approaches to modelling the insolation, thermal and power production functions of a PV system.

Tests of the insolation model at Sandia have demonstrated that its predictions of radiation on tilted surfaces are typically within 1% to 3% of measured radiation, often with random variance. The module temperature model can consistently predict these temperatures to within about 5% accuracy with random variance. The DC power model uses estimates of plane of array insolation and module temperature to compute the power from the system. This model uses the power degradation coefficient, a module reference efficiency and temperature, and the array size to estimate the total PV array power. The accuracy of these estimates depends primarily on the plane of array insolation estimates and secondarily on the estimates of module temperatures.

### 3.2 LCP - Lifetime Cost & Performance Model

This model was developed at the Jet Propulsion Laboratory [4] to provide an analytical structure for causally relating a comprehensive set of technical and economic factors to the resulting stream of PV system performance, cost, and dollar value over the system lifetime. The model of PV system performance in LCP focuses on the array level for system modeling although fairly detailed degradation and failure analysis capabilities do exist at the cell and module level.

The approach taken by LCP emphasizes performance and cost over the life of the system. The hourly PV performance model for non-degraded PV system operations resembles several of the other models described in this report. LCP then incorporates the effects of system degradation due to various mechanisms, and site-specific characteristics which are modeled in detail. The model also allows for operations and maintenance activities to be performed and accounts for their effect on performance and cost.

## 4.0 PV ARRAY PERFORMANCE PREDICTION

As seen from figure 1 both PVFORM and LCP models can simulate the performance of photovoltaic arrays when appropriate data are supplied. We have validated both of these models against measurements of AC power obtained from the 4-kW PV test facility of the Carolina Power and Light Company in Raleigh, North Carolina [1]. Some sample results are provided in Tables 2 through 4. In fact both models perform quite well when actual data for global horizontal insolation, ambient temperature and wind speed at the site are used.

One, however, realizes that while validation is possible with historical data, one needs to have predictions for the same variables if an estimate for the PV array performance is desired for a future date. So the question is how to obtain estimates for global and direct insolation, ambient temperature and wind speed. The most common answer to that question is - use the typical meteorological year (TMY) data. TMY tapes provide such data for typical months of a synthetic year for 234 locations within the United States. Use of TMY global and direct insolation data in PVFORM and LCP models, however, generally fail to represent the actual output of a photovoltaic array. See Tables 2 through 4 and figures 6 through 8 for comparison.

Another approach has been presented by Rahman [1] which determines the "Mode" of insolation, ambient temperature and wind speed history over a long time. Long-term historical data available from SOLMET tapes are used for this purpose. Discussion on mode is provided in the following.

The "Mode" is defined as the value that occurs most frequently in the sample [5]. If data is grouped into class intervals, it is difficult to locate the mode exactly. Under such circumstances the best approach is to approximate the mode. This is accomplished by first choosing the modal class and then picking out the class interval that shows the highest frequency. The sample mode is then approximated by:-

$$MO = L_{mo} + [d_1 / (d_1 + d_2)](w)$$

where

$L_{mo}$  = lower limit of modal class

$d_1$  = the diff. (sign neglected) between  
the frequency of the modal class and  
the frequency of the preceding class

$d_2$  = the diff. (sign neglected) between  
the frequency of the modal class and  
the frequency of the following class

$w$  = width of the modal class

In our example we plot the frequency histogram of the insolation data that ranges from roughly 0 to 1000 watts/m<sup>2</sup>. A sample frequency plot of insolation data is given in figure 2. Then we divide the sample into two segments depending on conspicuous peaks and break points. Two modes are then calculated using the equation above. Finally a weighted average value of the mode is obtained that reflects the number of data points in each of the two sub-samples. Henceforth we shall call this approach the VPI model.

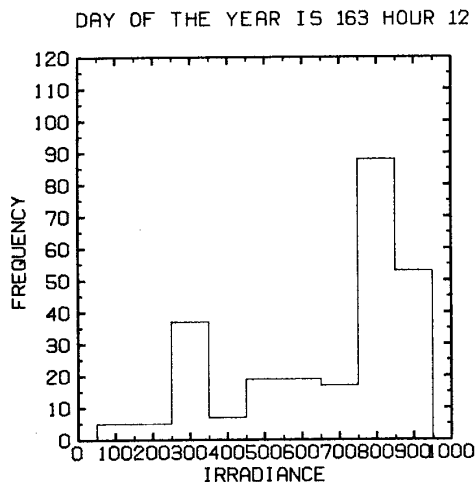

Figure 2. Histogram of Insolation Data

We have also examined a simple average of long term historical insolation data to generate PV array output estimates. Sample hourly averages for 5 particular days were developed using the 25 year SOLMET database for Raleigh-Durham. The estimated PV outputs by using the average data are shown in figures 6, 7 and 8.

The above mentioned approach is used to generate the predictions for global horizontal insolation, ambient temperature and wind speed. However, the data on direct normal (beam) insolation are very hard to find. For example, the SOLMET tape for Raleigh-Durham airport does not contain measured beam insolation. The TMY tape for this location has only synthetic beam insolation. We have utilized three sources for such data. These are: (i) TMY synthetic data, (ii) estimate of direct normal insolation from global horizontal insolation data using equations provided in the LCP model, and (iii) a World Meteorological Organization (WMO) model [6] for beam insolation.

## 5.0 RESULTS & DISCUSSION

In keeping with the objective of this paper, results are presented in two parts. The first part deals with validating PVFORM and LCP models, using historical data, against actual field measurements of PV power at the 4-kW PV test facility in Raleigh, North Carolina. The second part deals with using these models to predict the performance of the same 4-kW PV test facility and comparing these predictions with actual output. Details are provided in the following.

### 5.1 Model Validation

In order to validate the models we have used the observed global horizontal insolation, wind speed, ambient temperature, and modeled direct normal insolation data to estimate the AC power for a 4-kW PV test facility in Raleigh, NC. Results of these tests are presented in figures 3 through 5.

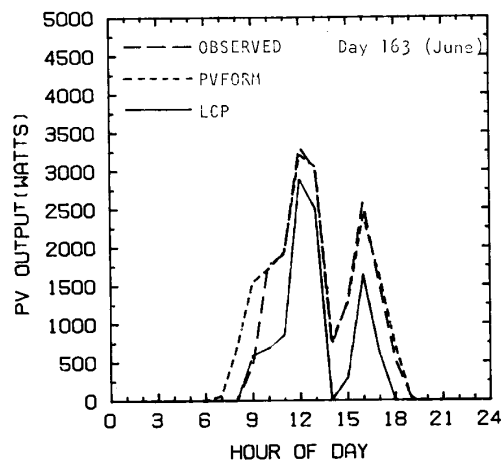

Figure 3. Performance Comparison of PVFORM & LCP

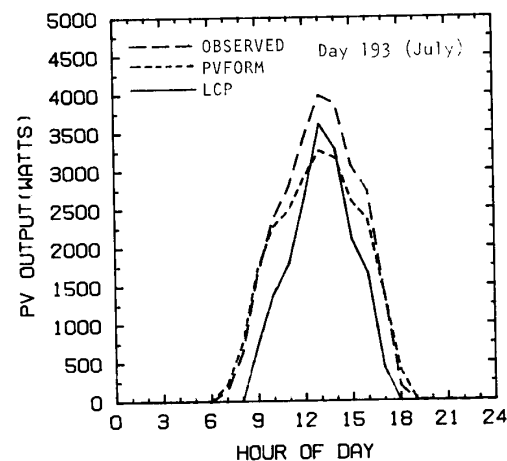

Figure 4. Performance Comparison of PVFORM & LCP

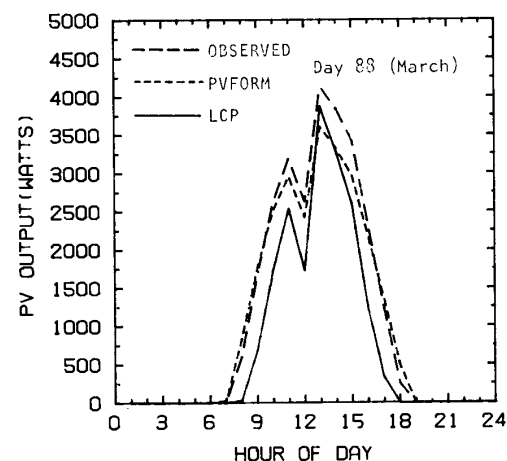

Figure 5 Performance Comparison of PVFORM & LCP

Three sets of plots for three sample days in March, June and July in 1985 are presented in these figures. It is clear that peaks, valleys and AC outputs in general, are quite well estimated by both PVFORM and LCP models. And between them, the PVFORM output tracks the observed AC power output better than the LCP output. Similar comparisons have been made for other days in other months of 1985 and similar trends were observed.

In view of the closer estimate provided by the PVFORM model in replicating the observed AC power for several sample days during the spring and summer of 1985, we chose to use this model for predicting the performance of the 4-kW PV test facility. One would, however, realize that in order to predict the PV array performance, one needs prediction of the input variables listed in figure 1, namely - global horizontal insolation, direct insolation, ambient temperature and wind speed. In the following section we discuss how such predicted values are obtained and utilized.

5.2 Array Performance Prediction

The two types of predicted data are: (i) typical meteorological year (TMY) data and (ii) the mode of long term observations for the same variables obtained from SOLMET tapes as discussed in section 4. In our experiment we have used the TMY and SOLMET data for the Raleigh-Durham airport which is approximately 30 miles from the 4-kW PV test facility of the Carolina Power and Light Company.

After checking various combinations of global horizontal and direct normal insolation data, obtained from different sources as listed in section 4, we have settled on four as shown in Tables 2, 3 and 4. These are: (i) TMY global/TMY direct, (ii) actual global/TMY direct, (iii) actual global/LCP direct and (iv) VPI global/LCP direct. These are listed as TMY/TMY, ACT/TMY, ACT/LCP and VPI/LCP respectively. The prediction of AC power when the WMO equation generated direct insolation was used, was not satisfactory and was therefore discarded from further consideration. Estimates of AC power using these data are compared against the field observations shown under OBSERV in these tables. It must be mentioned here that, whenever we have used the actual global insolation, we have also used the actual ambient temperature and wind speed data.

An examination of Tables 2, 3 and 4 shows that the estimates of AC power obtained from the actual global/LCP direct combination best match the observed AC power readings for the three days (under consideration) in March, June and July of 1985. However, one quickly realizes that one cannot have the actual global horizontal insolation readings for a future date when AC power output is to be predicted. Therefore, we must resort to some sort of estimate of input data for predicting the future PV output.

TABLE 2. AC Power Outputs for Day 88 (March)

HOURLY	TMY/TMY	ACT/TMY	ACT/LCP	VPI/LCP	OBSERV
1	0	0	0	0	0
2	0	0	0	0	0
3	0	0	0	0	0
4	0	0	0	0	0
5	0	0	0	0	0
6	0	0	0	0	0
7	0	38	25	0	20
8	506	939	829	171	600
9	1608	1803	1761	978	1670
10	2636	2569	2502	2012	2620
11	3310	2972	2954	2686	3190
12	3597	2561	2424	2992	2630
13	3831	2996	3600	3404	4130
14	1316	2709	3326	3848	3840
15	1215	2755	2962	3329	3420
16	2548	2028	2185	2565	2330
17	1791	1206	1363	2032	1230
18	1024	397	489	988	250
19	199	0	0	130	0
20	0	0	0	0	0
21	0	0	0	0	0
22	0	0	0	0	0
23	0	0	0	0	0
24	0	0	0	0	0

TABLE 3. AC Power Outputs for Day 163 (June)

HOURLY	TMY/TMY	ACT/TMY	ACT/LCP	VPI/LCP	OBSERV
1	0	0	0	0	0
2	0	0	0	0	0
3	0	0	0	0	0
4	0	0	0	0	0
5	0	0	0	0	0
6	48	0	1	0	0
7	627	16	64	0	0
8	1431	597	698	690	0
9	2220	1584	1545	1310	470
10	2771	1728	1719	1805	1770
11	3160	1983	1939	2314	1910
12	3245	3211	3210	2799	3310
13	3322	3056	3049	2577	3020
14	2528	883	777	2602	720
15	2570	1363	1270	2607	1300
16	2154	2408	2408	2340	2580
17	1376	1680	1634	1714	1520
18	625	732	707	913	520
19	43	10	16	0	30
20	0	0	0	0	0
21	0	0	0	0	0
22	0	0	0	0	0
23	0	0	0	0	0
24	0	0	0	0	0

TABLE 4. AC Power Outputs for Day 193 (July)

HOURLY	TMY/TMY	ACT/TMY	ACT/LCP	VPI/LCP	OBSERV
1	0	0	0	0	0
2	0	0	0	0	0
3	0	0	0	0	0
4	0	0	0	0	0
5	0	0	0	0	0
6	6	3	3	0	0
7	383	176	204	0	130
8	967	740	747	534	620
9	1645	1678	1713	1120	1650
10	2289	2187	2271	1862	2370
11	2503	2426	2479	2320	2780
12	2529	2797	2915	2721	3430
13	2441	3125	3262	3079	3980
14	2587	3103	3168	2602	3880
15	2608	2545	2598	2528	3060
16	2192	2366	2361	2457	2740
17	1460	1393	1409	1750	1420
18	626	243	399	942	190
19	26	11	17	4	0
20	0	0	0	0	0
21	0	0	0	0	0
22	0	0	0	0	0
23	0	0	0	0	0
24	0	0	0	0	0

In order to predict the PV output, all variables of concern are obtained from TMY tapes and the VPI model discussed in section 4. Results are shown in these tables under column headings TMY/TMY and VPI/LCP respectively. The TMY/TMY case uses both global horizontal and direct normal insolation data from the TMY tapes. VPI/LCP case uses the global horizontal insolation as obtained from the VPI model, and the direct normal insolation as estimated using the appropriate equation from the LCP model. On the basis of the sum of the absolute error for power output during the daylight hours it is seen that the VPI/LCP data predict the actual AC power outputs significantly better than the TMY/TMY data. For visual comparison, this information is also presented in figures 6, 7 and 8. Here we also show the estimated PV array output by using a simple average hourly insolation data. The average data generates a bell shaped curve for PV output, as expected. It is also clearly seen that the VPI model generated data replicates the observed data better both in terms of the peak and the overall shape. It may be added that, in both cases the PVFORM model was used for performance prediction.

6.0 CONCLUSIONS

We have tested and validated PVFORM and LCP photovoltaic performance analysis models. PVFORM appears to estimate the actual AC power output better than LCP model. We have presented a technique to determine the mode of long term meteorological data. This is called the VPI model. The ability of the PVFORM and LCP models to predict future AC power output of a 4-kW PV test facility has been examined using the TMY data, and the data estimate obtained from VPI model. Our test results show that the VPI model estimated meteorological data, when used with the PVFORM model, gives the best prediction of AC power output for Raleigh, North Carolina.

7.0 ACKNOWLEDGEMENT

The authors gratefully acknowledge the sponsorship of the Virginia Center for Coal and Energy Research and the Carolina Power and Light Company for this research. We also thank Mr. M. A. Khallat for providing the VPI model generated insolation, temperature and wind speed data.

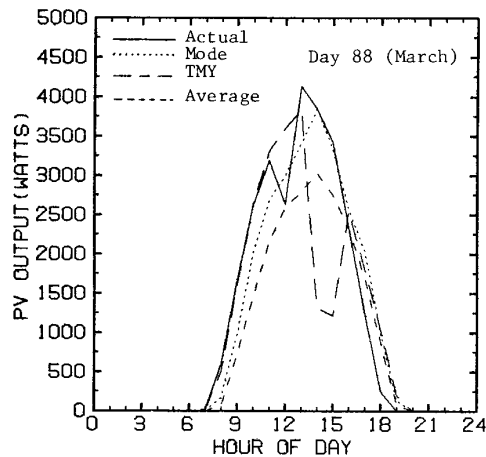

Fig.6 Comparison of TMY & VPI Models for March Data

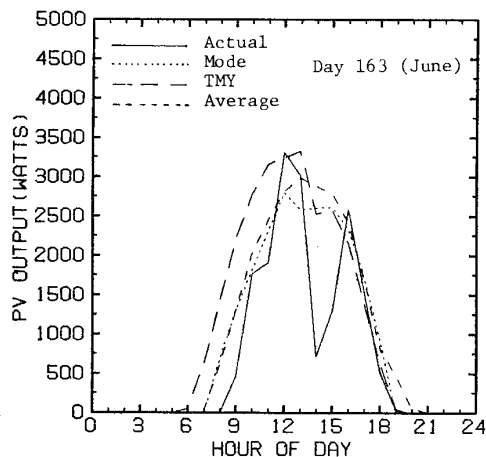

Fig. 7 Comparison of TMY & VPI Models for June Data

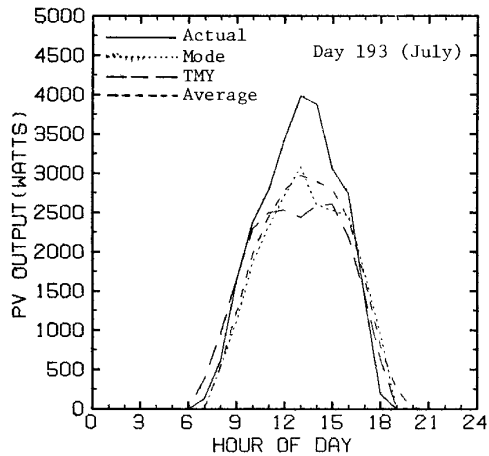

Fig. 8 Comparison of TMY & VPI Models for July Data

## 8.0 REFERENCES

1. S. Rahman, "Capacity and Energy Values from Photovoltaic Systems in the Carolina Power & Light Company Service Area", Final Report, Carolina Power & Light Company, November 1985, 92 p.
2. J. H. Smith and L. R. Reiter, "Photovoltaic Performance Models - A Report Card", Mechanical Engineering, vol. 107, August 1985, pp. 22-27.
3. D. E. Menicucci, "PVFORM - A Photovoltaic System Analysis Program", draft report, Sandia National Laboratory, September 1985.
4. C. S. Borden, "Lifetime Cost and Performance Model for Distributed Photovoltaic Systems", Vol 1: Summary, JPL Doc. 5220-12, Jet Propulsion Laboratory, Pasadena, California, August 1981.
5. B. Ostle and R. W. Mensing, Statistics In Research, Iowa State University Press, 1975.
6. R. Dogniaux, "Computer Procedure for Accurate Calculation of Radiation Data Related to Solar Energy Utilization", Proc. UNESCO/WMO Symposium, Solar Energy, WMO No. 477, Geneva, Aug-Sept. 1976, pp. 191-197.

Saifur Rahman (S-75, M-78, SM-83) graduated from the Bangladesh University of Engineering and Technology in 1973 with a B. Sc. degree in Electrical Engineering. He obtained his M.S. degree in Electrical Sciences from the State University of New York at Stony Brook in 1975. His Ph.D. degree (1978) is in Electrical Engineering from the Virginia Polytechnic Institute and State University.

Saifur Rahman has taught in the Department of Electrical Engineering, the Bangladesh University of Engineering and Technology, the State University of New York at Stony Brook, the Texas A&M University and the Virginia Polytechnic Institute and State University where he is an Associate Professor. His industrial experience includes work at the Brookhaven National Laboratory, New York and the Carolina Power and Light Company. He is a member of the IEEE Power Engineering and Computer Societies and the American Solar Energy Society. He serves on the System Planning and Load Management subcommittees of the IEEE Power Engineering Society. His areas of interest are large scale optimization, power system planning and alternative energy systems. He has authored more than 60 technical papers and reports in these areas.

Badrul H. Chowdhury (S-83) graduated from the Bangladesh University of Engineering and Technology in 1981 with a B.Sc. degree in Electrical Engineering. He obtained his M.S. in Electrical Engineering from the Virginia Polytechnic Institute and State University in 1983. He is currently working on his doctorate in Electrical Engineering. His major research interests include alternative energy systems and computer applications in power systems planning.