

2006

Completely Explosive Autonomous High-Voltage Pulsed-Power System Based on Shockwave Ferromagnetic Primary Power Source and Spiral Vector Inversion Generator

Sergey I. Shkuratov

Evgueni F. Talantsev

Jason Baird

Missouri University of Science and Technology, jbaird@mst.edu

Millard F. Rose

et. al. For a complete list of authors, see https://scholarsmine.mst.edu/min_nuceng_facwork/1175Follow this and additional works at: https://scholarsmine.mst.edu/min_nuceng_facworkPart of the [Explosives Engineering Commons](#)

Recommended Citation

S. I. Shkuratov et al., "Completely Explosive Autonomous High-Voltage Pulsed-Power System Based on Shockwave Ferromagnetic Primary Power Source and Spiral Vector Inversion Generator," *IEEE Transactions on Plasma Science*, vol. 34, no. 5, pp. 1866-1872, Institute of Electrical and Electronics Engineers (IEEE), Jan 2006.

The definitive version is available at <https://doi.org/10.1109/TPS.2006.883347>

This Article - Journal is brought to you for free and open access by Scholars' Mine. It has been accepted for inclusion in Mining and Nuclear Engineering Faculty Research & Creative Works by an authorized administrator of Scholars' Mine. This work is protected by U. S. Copyright Law. Unauthorized use including reproduction for redistribution requires the permission of the copyright holder. For more information, please contact scholarsmine@mst.edu.

Completely Explosive Autonomous High-Voltage Pulsed-Power System Based on Shockwave Ferromagnetic Primary Power Source and Spiral Vector Inversion Generator

Sergey I. Shkuratov, *Member, IEEE*, Evgueni F. Talantsev, Jason Baird, *Member, IEEE*, Millard F. Rose, *Fellow, IEEE*, Zachary Shotts, Zack Roberts, Larry L. Altgilbers, *Member, IEEE*, and Allen H. Stults

Abstract—Novel explosive and conventional pulsed-power technologies were combined, and a series of explosive-driven high-voltage power supplies was designed, built, and tested. The power supply contained an explosive-driven high-voltage primary power source based on the fundamental physical effect of shockwave demagnetization of $\text{Nd}_2\text{Fe}_{14}\text{B}$ high-energy ferromagnet and a power-conditioning stage. The volume of the energy-carrying ferromagnetic elements in the shockwave ferromagnetic generators (FMGs) was 8.75 cm^3 . The power-conditioning stage was based on the spiral vector inversion generator (VIG). The combined FMG–VIG system demonstrated successful operation and good performance. The output-voltage pulse amplitude of the combined FMG–VIG system exceeded 40 kV, with a rise time of 6.2 ns. The methodology was developed for digital simulation of the operation of completely explosive FMG–VIG system. Experimental results obtained are in a good agreement with the results of digital calculations performed.

Index Terms—Direct energy conversion, explosive pulsed power, hard ferromagnets, shockwave demagnetization.

I. INTRODUCTION

PULSED-POWER systems without any external power supplies (commonly named autonomous pulsed-power systems) are important to the success of many scientific and engineering projects [1]–[6]. Novel types of compact and ultracompact autonomous explosive-driven pulsed-power sources, utilizing the electromagnetic energy stored for an infinite period of time in high-energy hard ferrimagnets and hard ferromagnets, were developed recently [7]–[21]. Operation of these devices is based on the fundamental physical effects of shockwave demagnetization of hard ferrimagnets [7], [12] and hard ferromagnets [8]–[21]. Miniature ($9\text{--}25 \text{ cm}^3$ in volume) generators based on these effects are capable of producing high-voltage pulses with amplitudes greater than 20 kV and pulses of high current with amplitudes exceeding 4 kA

[8]–[21]. New technology [8]–[21] is expanding quickly in the pulsed-power research and engineering community in the U.S. and other countries. Since 2005, explosive-driven autonomous pulsed-power sources based on the effect of shockwave demagnetization of hard ferromagnets [8]–[21] have been under development in China [22].

Earlier [14]–[16], we demonstrated the fundamental possibility of constructing a completely explosive two-stage pulsed-power system containing explosive-driven high-current shockwave ferromagnetic primary power generator as a seed source and spiral magnetic flux compression generator as a pulsed-power amplifier. In the last few months [23], we successfully developed a two-stage compact autonomous explosive-driven pulsed-power system utilizing a high-voltage compact explosive-driven shockwave ferromagnetic generator (FMG) as a charging source for capacitive energy storage.

In this paper, we present another new concept for constructing compact autonomous explosive-driven pulsed-power systems. This concept is based on a high-voltage ultracompact explosive-driven FMG as a primary power source and a conventional pulsed-power transformer [the spiral vector inversion generator (VIG) [26]] as a power-conditioning stage.

II. PRINCIPLES OF OPERATION AND EXPERIMENTAL TECHNIQUES

The general design of high-voltage shockwave FMG, the schematic of loading the explosive, and the disposition of the detonator are shown in Fig. 1. The generator contains a hard ferromagnetic $\text{Nd}_2\text{Fe}_{14}\text{B}$ energy-carrying element, a high-explosive charge, a plastic pulse-generating coil holder with a multiturn coil wound on it, and an output high-voltage terminal system.

The design of the $\text{Nd}_2\text{Fe}_{14}\text{B}$ energy-carrying element was made as a hollow cylinder magnetized along the axis (Fig. 1). During generator operation, high explosive loaded in the central hole along the axis of the ferromagnetic energy-carrying element is detonated, creating a transverse shockwave (the shock wave propagates across the magnetization vector \vec{M}) in the body of the $\text{Nd}_2\text{Fe}_{14}\text{B}$ hard ferromagnet. Further development of the generator design has made it possible to dramatically reduce the amount of the desensitized RDX high explosive

Manuscript received November 2, 2005; revised July 27, 2006.

S. I. Shkuratov, E. F. Talantsev, and J. Baird are with Loki Inc., Rolla, MO 65409 USA.

M. F. Rose, Z. Shotts, and Z. Roberts are with Radiance Technologies, Inc., Huntsville, AL 3580 USA.

L. L. Altgilbers is with the U.S. Army Space and Missile Defense Command, Huntsville, AL 35807 USA.

A. H. Stults is with the U.S. Army Aviation and Missile Research, Development and Engineering Center, Huntsville, AL 35898 USA.

Digital Object Identifier 10.1109/TPS.2006.883347

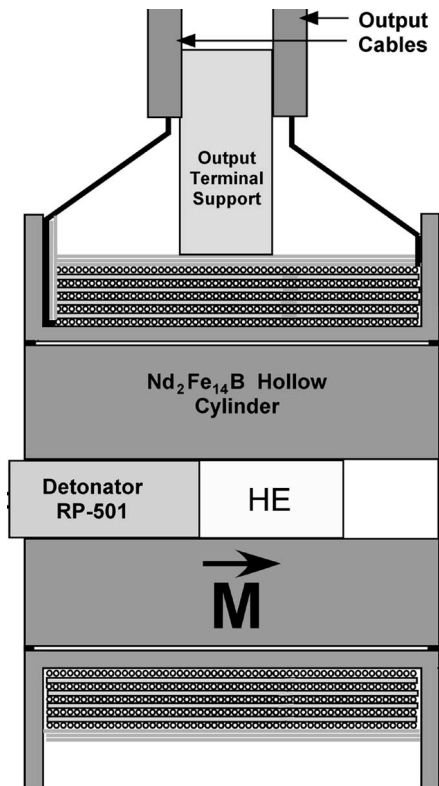

Fig. 1. General design of explosive-driven transverse shockwave high-voltage FMG.

(to 0.6 g), while still providing complete demagnetization of $Nd_2Fe_{14}B$ hard ferromagnet with an outer diameter of 25.4 mm, inner diameter of 8 mm, length of 19 mm, and weight of 68 g. In the generators described in this paper, a single RISI RP-501 exploding bridgewire detonator initiated the high-explosive detonation. All FMGs were loaded with 0.6 g of desensitized RDX high explosives (Chapman–Jouguet state pressure of 22.36 GPa and detonation velocity of 8.1 km/s).

The plastic pulse-generating coil holder protects the pulse-generating system of the FMG against the mechanical action of the explosive charge for a few tens of microseconds. In addition, the coil holder provides electrical insulation between the pulse-generating coil and the ferromagnetic energy-carrying element (which is connected to electrical ground potential through the detonator wires).

For fabrication of multiturn pulse-generating coils of the FMGs, a heavily insulated magnet wire was used. A typical high-voltage FMG containing 252-turn pulse-generating coil is shown in Fig. 2 (diameter of the generator is 34 mm, and length of the generator is 19 mm). FMGs contained $Nd_2Fe_{14}B$ hollow ferromagnetic cylinders with an outer diameter of 25.4 mm, inner diameter of 8 mm, and length of 19 mm. The parameters of the $Nd_2Fe_{14}B$ material in a closed magnetic circuit are: residual flux density $B_r = 1.23$ T, coercive force $H_c = 8.99 \cdot 10^5$ A/m, and maximum energy product $BH_{max} = 0.279$ J/cm³; industry tolerance: $B_r \pm 5\%$, $H_c \pm 8\%$, and $BH_{max} \pm 10\%$.

The VIG is a pulse generator which, as a single unit, can store an electric charge at one voltage and discharge it as a pulse having a peak value higher than the stored voltage [26].

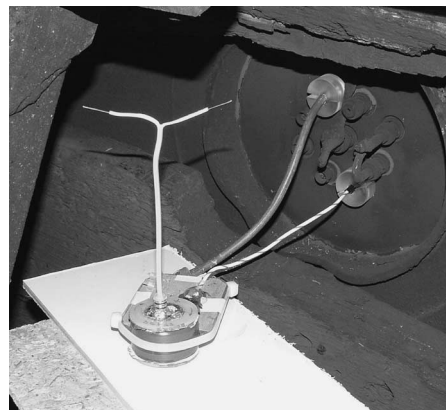

Fig. 2. High-voltage FMG prepared for explosive and electrical operation. The generators contained $Nd_2Fe_{14}B$ energy-carrying element with an outer diameter of 25.4 mm, inner diameter of 8 mm, length of 19 mm, and pulse-generating coil of 252 turns.

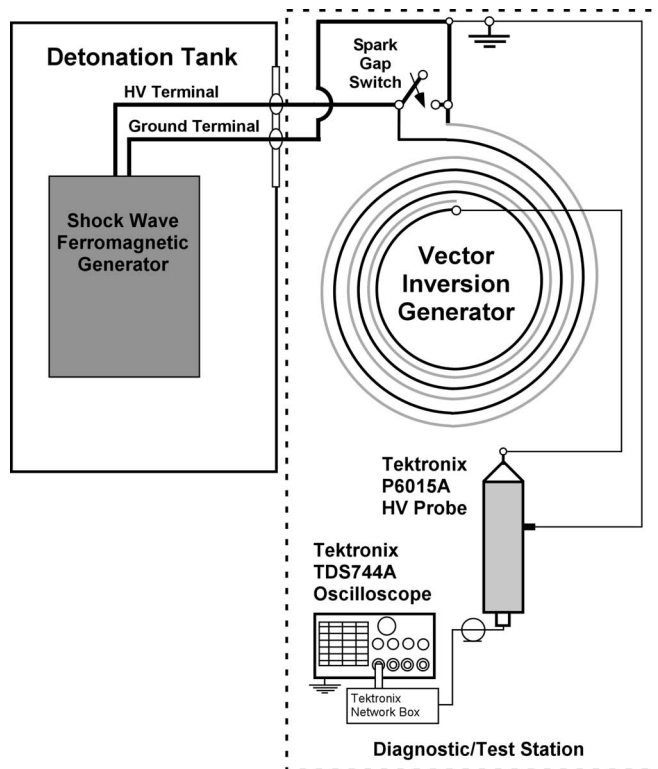

Fig. 3. Schematic diagram of the experimental setup used to test the completely explosive FMG–VIG system.

Schematic diagram of the VIG is shown in Fig. 3. The VIG contains two sheets of conductive material and two sheets of electrically insulating material arranged alternatively and wound together into a roll forming open-ended transmission line. If we charge this rolled foil capacitor to voltage U_0 and after that we close the spark-gap switch, as a result of the discharge, the electromagnetic wave originates from the switch and travels along the transmission line. As the wave travels, it converts the electrostatic field into an electromagnetic field, and when it retraces its path after reflection at the end of the transmission lines, it converts the electromagnetic field back into an electrostatic field. An output pulse of amplitude $U_{out} = 2nU_0$ (n is a number of turns in the roll) and the rise time equal to double

electrical length of the transmission line appear at the contacts of the VIG. The advantage of this system is simplicity and short (nanosecond) rise time of the generated pulse. All VIGs used in the experiments had these outside dimensions: 60 mm in length, 30 mm in width, and 110 mm in height.

We performed the explosive experiments at the Rock Mechanics and Explosive Research Center of the University of Missouri–Rolla, where we designed and constructed an experimental system to study explosive-driven pulsed power and microwave sources. The setup has a diagnostic/test station (Fig. 3) and a detonation tank where we fire the explosive-driven generators. The detonation tank is a cylindrical steel chamber 1.5 m in diameter and 5 m in length, having a nominal 2.54-cm wall thickness. The tank is capable of withstanding nonfragmenting tests of up to 1 kg of high explosives. The explosive-driven generators tested are placed inside the detonation tank near a stainless-steel side port. The diagnostic/test station containing probes, oscilloscopes, and other diagnostic and experimental equipment is sited near the side port, but outside of the detonation tank.

Some of generator's output cables are connected to the diagnostic/test station through air-sealed connectors in the port, and other output cables are connected to the diagnostic/test station directly. In order to avoid mechanical strains being transmitted through the generator's output cables to the pulse measuring and recording systems during generator firing, the output cables are fixed in the port cover using specially developed cylindrical clamps. During generator explosive operation, the cables cut off at their generator connections instead of the measuring system connections. Since mechanical strains are not transferred to the diagnostic/test station through the cables, there is no mechanical effect from the explosive detonation on the results of the electrical measurements. Positioning the sensitive equipment outside the tank in this manner protects the equipment from the explosive environment within the tank, thereby preventing test-related damage.

The arrangement of the shockwave experiments and the circuit diagram of the measuring system are given in Fig. 3. The output high-voltage pulses were measured with a Tektronix P6015A high-voltage probe (rise time of 4 ns, input impedance of 100 M Ω , and capacitance of 3 pF). The signals from the probe were recorded with Tektronix TDS744A (bandwidth of 500 MHz and 2 GS/s) and Tektronix TDS2024 (bandwidth of 200 MHz and 2 GS/s) oscilloscopes. The electric circuit parameters of the generators were measured with a Hewlett-Packard 4275 multifrequency LCR meter. Other experimental conditions and the equipment used corresponded to those described in the references [7]–[21], [23].

III. EXPERIMENTAL RESULTS

The VIG chosen for experiments described in this paper was a five-turn unit made of 0.1-mm (thickness) capacitor grade Teflon as the dielectric and 50.8-mm-wide 0.05-mm-thick copper shims as the capacitor conducting plates. This VIG was wound on a ferrimagnetic mandrel (ferrite 2535) of 25.4-mm width; as such, the VIG had a rectangular cross section, but this did not affect its efficiency. The voltage efficiency (measured by voltage multiplication) of the devices was in the 80%–90%

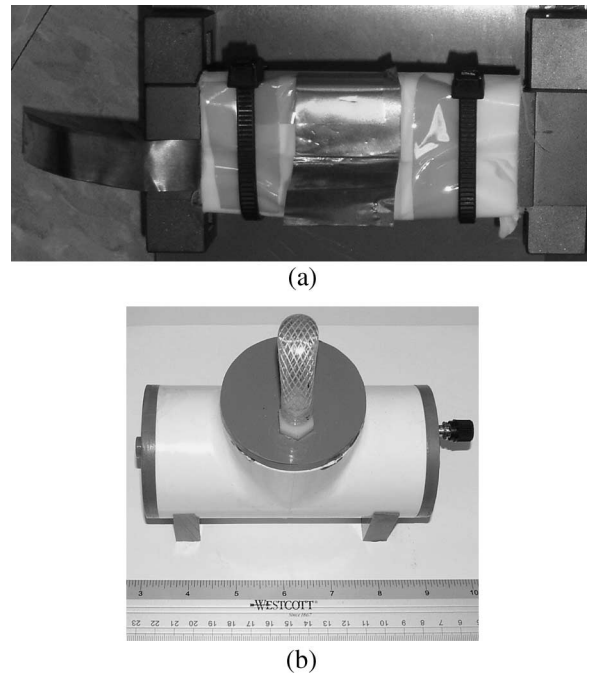

Fig. 4. (a) Photo of VIG used in these experiments. (b) VIG placed in the oil bath.

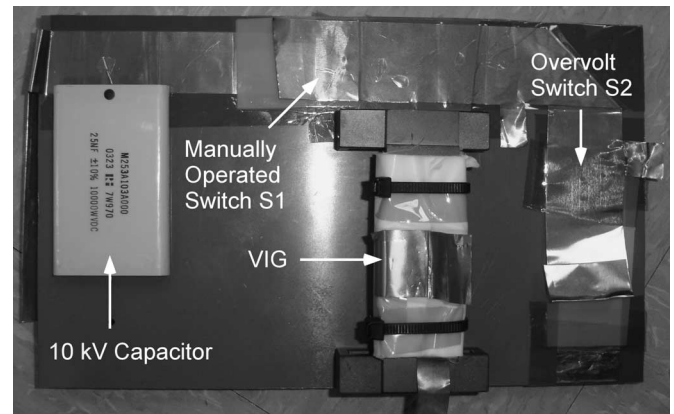

Fig. 5. Experimental setup for characterization of the VIG spark-gap switch.

range. The calculated capacitance of the devices was approximately 5.6 nF. The device was oil impregnated to eliminate corona effects and was capable of producing output voltages in excess of 30 kV. The VIG is shown in Fig. 4.

The development of a VIG spark-gap switch is mostly a matter of trial and error. We used a standard paper punch to make repeatable holes in the dielectric films, which could then be stacked to lengthen the gap. In this way, the switch inductance was kept at a minimum and the breakdown voltage could be somewhat controlled. To get some idea of the impulse behavior of the gap, we developed a simple test fixture to allow us to apply an impulse to the switch ensemble. A photo of the test setup is shown in Fig. 5.

A schematic diagram of the experimental setup used to test the FMG–VIG system is shown in Fig. 3. The FMG was placed inside the detonation tank. The output terminals of the FMG were connected to the input of the VIG. The negative terminal of the FMG was grounded. Correspondingly, the FMG

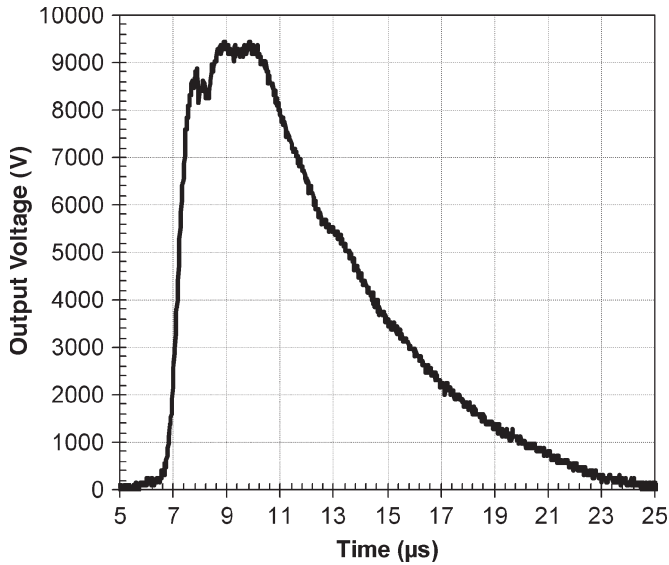

Fig. 6. Waveform of the pulsed EMF produced by an FMG (257-turn pulse-generating coil). Open-circuit operation.

produced a positive high-voltage pulse. This high-voltage pulse was applied to the input of the VIG spark gap. The output voltage of completely explosive FMG–VIG system was connected directly to the Tektronix P6015A high-voltage probe.

Operation of the FMG–VIG system is as follows. The explosive-driven FMG produces a high-voltage pulse of duration 5–8 μs that impulse charges the VIG. When the charge voltage exceeds the VIG spark-gap hold-off threshold, the VIG erects in a time equal to two wave transit times through the device (~ 6 ns), producing a transient voltage that is several times greater than the breakdown voltage of the VIG spark-gap switch.

The basis for the production of high voltage at the output terminals of FMG is Faraday's law that is related to the decrease in the initial magnetic flux in the ferromagnetic energy-carrying element due to shockwave action. For a multturn coil, the generated electromotive force (EMF) is the sum of the EMFs produced by all the turns

$$E_{m.-turn}(t) = \sum_N [-d\Phi_n(t)/dt] \quad (1)$$

where dt is the time in which the change in the magnetic flux in the turn, $d\Phi_n(t)$ is the magnetic flux captured by the n th turn of the multturn coil and N is the number of turns in the coil.

The first series of experiments was performed with FMGs operating in the open-circuit mode. A typical EMF waveform produced by a typical FMG containing a 257-turn pulse-generating coil operating in the open-circuit mode is shown in Fig. 6. The EMF pulse amplitude was $U_g(t)_{\max} = 9.44$ kV, FWHM = 6.67 μs , and $\tau = 1.2$ μs . The slope of the EMF curve at the moment of the beginning of demagnetization $\Delta U_g(t)_{\max}/\Delta t$ is 7.87 kV/ μs . There are no breaks or distortions in the EMF pulse waveform. The EMF specific peak $E_{m.-turn}(t)_{\max \text{ spec}}$ was 36.7 V/turn. The series resistance and the series inductance of the pulse-generating coil were $R_S(100 \text{ kHz}) = 15.1 \Omega$ and $L_S(100 \text{ kHz}) = 2.3$ mH, respectively.

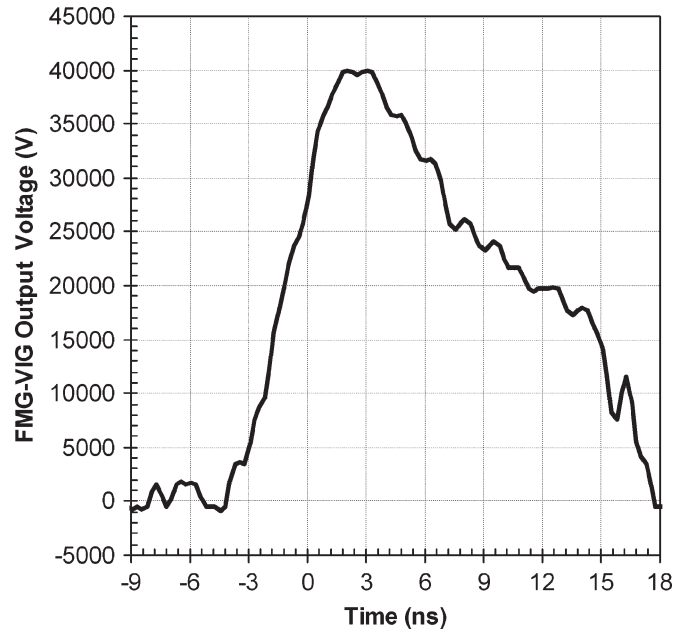

Fig. 7. Waveform of the high-voltage pulse produced by a completely explosive nanosecond FMG–VIG pulse-generating system.

We performed six experiments with generators of this type. The EMF pulse waveforms were very reproducible. The average EMF pulse amplitude was $U_g(t)_{\max} = 9.20 \pm 0.26$ kV. The average specific EMF peak for this type of FMG was $E_{m.-turn}(t)_{\max \text{ spec}} = 35.8 \pm 1.4$ V/turn.

Right before the FMG–VIG experiments, we preliminarily characterized the VIG spark gap in real time. The gap was tuned and set to break at $U = 5.9 \pm 0.3$ kV.

We performed five experiments with ultracompact explosive-driven FMG–VIG pulsed-power systems. Output-voltage pulse amplitude and shape were very reproducible. A typical waveform of a high-voltage pulse produced by an explosive-driven FMG–VIG system is shown in Fig. 7. The peak voltage amplitude was $U(t)_{\max} = 40.2$ kV, FWHM = 14 ns, and $\tau = 6.5$ ns. The slope of the output-voltage curve at the moment of the beginning of pulsed-power generation $\Delta U(t)_{\max}/\Delta t$ was 6.18 kV/ns. The slope of the output voltage $\Delta U(t)_{\max}/\Delta t$ of the FMG–VIG system is increased approximately on three orders of magnitude in comparison with the output voltage of the FMG primary power source. The average value of the peak voltage amplitude for the FMG–VIG system was $U(t)_{\max} = 39.4 \pm 1.9$ kV.

IV. DIGITAL CIRCUIT ANALYSIS

At the present time, it seems practically impossible to apply an analytical theoretical approach for describing pulsed generation in the FMG–VIG system. Instead of an analytical approach, we created an FMG–VIG digital model and performed analysis of the electrical circuit of the FMG–VIG system using the commercial PSpice code [27]. This approach allows us to predict the parameters of the output-voltage pulse due to scaling the FMG–VIG system.

The equivalent circuit of the FMG–VIG system employed in digital simulations is shown in Fig. 8. It consists of two parts. The first part is the FMG primary power source. It contains the

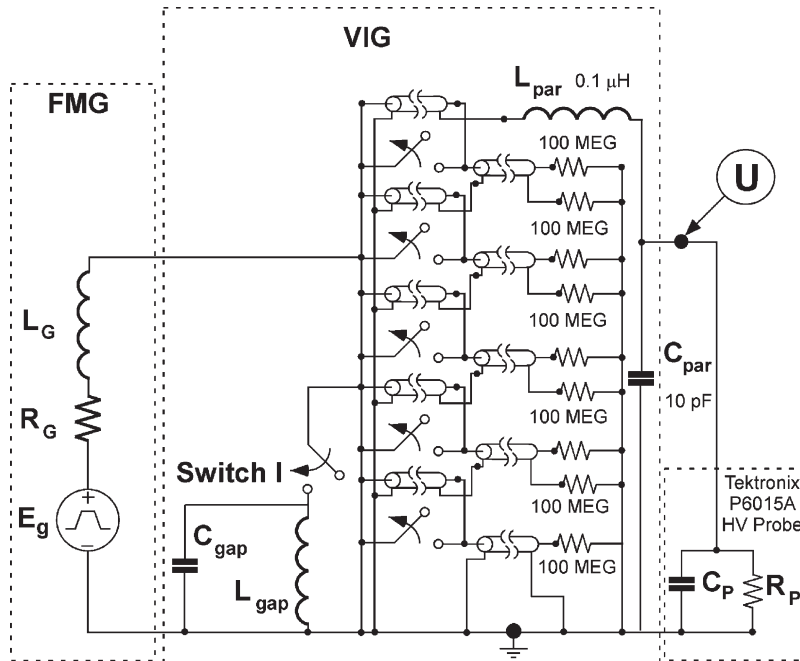

Fig. 8. Equivalent circuit of the FMG–VIG system employed in digital simulations.

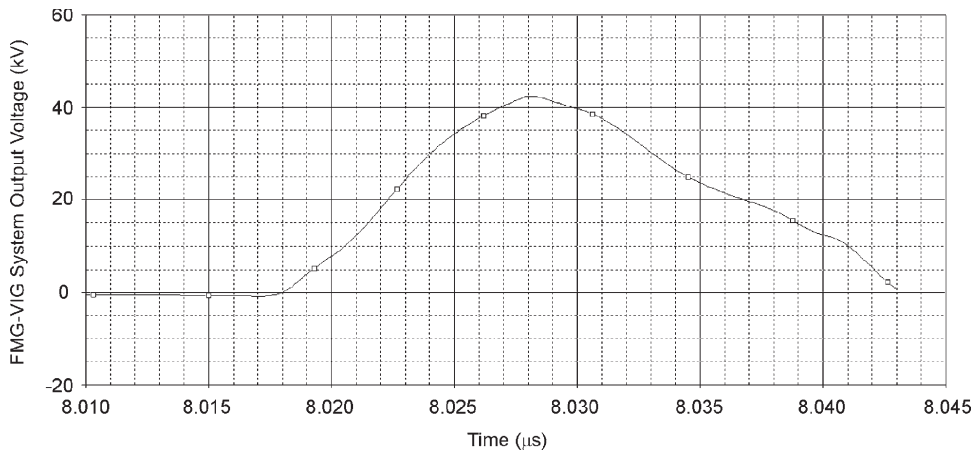

Fig. 9. Simulated waveform of the output voltage $U(t)$ produced by completely explosive FMG–VIG system.

FMG pulsed EMF E_g , the inductance L_G , and the resistance R_G of the FMG. The EMF pulse of the FMG, averaged from six experiments, was digitized in the source section of the PSpice code. The PSpice inductance and resistance of the FMG were as follows: $L_G = 2.25$ mH and $R_G = 15.0$ Ω. These values were averaged from 11 devices used in this experimental series.

The second part of the equivalent circuit is the VIG part (Fig. 8). Each turn and the next turn of the VIG were considered as a Blumlein line. A five-turn VIG used in the experiments was represented in the model as five Blumlein lines (five stages) connected in series (Fig. 8). The input capacitance of the VIG was 5.6 nF. The spark-gap switch of the VIG is shown in the equivalent circuit as switch I. The capacitance and inductance of the spark-gap switch in the model were $C_{gap} = 100$ pF and $L_{gap} = 10$ nH, respectively. The capacitance and resistance of Tektronix P6015A high-voltage probe were $C_p = 3$ pF and $R_p = 100$ MΩ, respectively.

Results of the simulation of FMG–VIG system are shown in Fig. 9. Switch I operated in this simulation at a voltage of 5.7 kV. Five stage switches provided short circuiting of the stages of the VIG during charging process. At 5 ns before the operation of switch I, all five stage switches of the system opened, and from this moment of time, the VIG worked as a line transformer. The amplitude of the voltage pulse produced by FMG–VIG system is 42 kV (Fig. 9), the rise time of the pulse is 10.5 ns, and the FWHM is 14.5 ns. Results of the simulation are in good agreement with experimental results.

V. SUMMARY

We have demonstrated successful operation, for the first time, of a completely explosive pulsed-power system based on explosive-driven FMGs as the primary power sources, with a VIG as a power-conditioning stage. Adding a VIG stage

increases the voltage output of the FMG by a factor depending on the VIGs parameters, while simultaneously compressing the pulse into the range of a few nanoseconds. The combination produces an extremely high-power dense single-shot pulser that is unrivaled for specific power. We have developed the methodology for digital simulation of the operation of a two-stage explosive-driven FMG–VIG system. We expect to use this methodology to scale the FMG–VIG system. Fields of possible applications of autonomous FMG–VIG power systems are high-power microwave technology [1]–[6], explosive-driven pulsed power [2], [5], [6], and less-than-lethal munitions.

ACKNOWLEDGMENT

The authors would like to thank Dr. A. V. Ponomarev (Institute of Electrophysics of the Russian Academy of Sciences) for his help in the development of the model of the FMG–VIG system.

REFERENCES

- [1] G. A. Mesyats, *Pulsed Power*. New York: Plenum, 2005.
- [2] M. Kristiansen, A. Neuber, J. C. Dickens, A. Giesselmann, and S. Shkuratov, "Compact pulsed power," in *Proc. 10th Int. Conf. Megagauss Magnetic Field Generation and Related Topics (Megagauss-X)*, M. von Ortenberg, Ed, Sarov, Russia, 2005, pp. 169–175.
- [3] *High-Power Microwave Sources and Technologies*, R. J. Barker and E. Shamiloglu, Eds. New York: IEEE, 2001.
- [4] D. V. Giri, *High-Power Electromagnetic Radiators: Nonlethal Weapons and Other Applications*. Cambridge, MA: Harvard Univ. Press, 2004.
- [5] in *Proc. 10th Int. Conf. Megagauss Magnetic Field Generation and Related Topics (Megagauss-X)*, M. von Ortenberg, Ed, Sarov, Russia, 2005.
- [6] L. L. Altgilbers, M. D. J. Brown, I. Grishnaev, B. M. Novac, I. R. Smith, I. Tkach, and Y. Tkach, *Magnetocumulative Generators*. New York: Springer-Verlag, 2000.
- [7] S. I. Shkuratov, E. F. Talantsev, J. C. Dickens, and M. Kristiansen, "Shock wave demagnetization of BaFe₁₂O₁₉ hard ferrimagnetics," *J. Appl. Phys.*, vol. 91, no. 5, pp. 3007–3009, Mar. 2002.
- [8] —, "Ultracompact explosive-driven high-current source of primary power based on shock wave demagnetization of Nd₂Fe₁₄B hard ferromagnetics," *Rev. Sci. Instrum.*, vol. 73, no. 7, pp. 2738–2742, Jul. 2002.
- [9] —, "Transverse shock wave demagnetization of Nd₂Fe₁₄B high-energy hard ferromagnetics," *J. Appl. Phys.*, vol. 92, no. 1, pp. 159–162, Jul. 2002.
- [10] S. I. Shkuratov, E. F. Talantsev, J. C. Dickens, M. Kristiansen, and J. Baird, "Longitudinal-shockwave compression of Nd₂Fe₁₄B hard ferromagnet: The pressure induced magnetic phase transition," *Appl. Phys. Lett.*, vol. 82, no. 8, pp. 1248–1251, Feb. 2003.
- [11] E. F. Talantsev, S. I. Shkuratov, J. C. Dickens, and M. Kristiansen, "The conductivity of a longitudinal-shockwave-compressed Nd₂Fe₁₄B hard ferromagnetics," *Mod. Phys. Lett. B*, vol. 16, pp. 545–554, 2002.
- [12] S. I. Shkuratov, E. F. Talantsev, J. C. Dickens, and M. Kristiansen, "Compact explosive-driven generator of primary power based on a longitudinal shock wave demagnetization of hard ferri- and ferromagnets," *IEEE Trans. Plasma Sci.*, vol. 30, no. 5, pp. 1681–1691, Oct. 2002.
- [13] —, "Currents produced by explosive driven transverse shock wave ferromagnetic source of primary power in a coaxial single-turn seeding coil of a magnetocumulative generator," *J. Appl. Phys.*, vol. 93, no. 8, pp. 4529–4535, Apr. 2003.
- [14] E. F. Talantsev, S. I. Shkuratov, J. C. Dickens, and M. Kristiansen, "Completely explosive pulsed power mini-system," *Rev. Sci. Instrum.*, vol. 74, no. 1, pp. 225–230, Jan. 2003.
- [15] S. I. Shkuratov and E. F. Talantsev, "Powering the coaxial single-turn seed coil of a magnetocumulative generator by an explosive-driven shock wave ferromagnetic primary source," *J. Electromagn. Phenomena*, vol. 3, no. 4, pp. 452–467, 2003.
- [16] E. F. Talantsev, S. I. Shkuratov, J. C. Dickens, and M. Kristiansen, "An autonomous completely explosive pulsed power mini-system," in *Proc. IX Int. Conf. Megagauss Magnetic Field Generation and Related Topics (Megagauss-9)*, V. D. Selemir and L. N. Plyashkevich, Eds, Sarov, Russia, 2004, pp. 239–246.
- [17] S. I. Shkuratov, E. F. Talantsev, J. C. Dickens, and M. Kristiansen, "Seed currents produced by ultracompact explosive-driven transverse shock wave ferromagnetic generator of primary power in a coaxial single-turn seeding coil of a magnetocumulative generator," in *Proc. IX Int. Conf. Megagauss Magnetic Field Generation and Related Topics (Megagauss-9)*, V. D. Selemir and L. N. Plyashkevich, Eds, Sarov, Russia, 2004, pp. 247–254.
- [18] —, "Dimensional effects for explosive-driven ferromagnetic primary power source seeding a magnetocumulative generator," in *Proc. IX Int. Conf. Megagauss Magnetic Field Generation and Related Topics (Megagauss-9)*, V. D. Selemir and L. N. Plyashkevich, Eds, Sarov, Russia, 2004, pp. 255–267.
- [19] —, "Autonomous ultracompact explosive-driven high-voltage generator based on transverse shock wave demagnetization of Nd₂Fe₁₄B hard ferromagnets," in *Proc. IX Int. Conf. Megagauss Magnetic Field Generation and Related Topics (Megagauss-9)*, V. D. Selemir and L. N. Plyashkevich, Eds, Sarov, Russia, 2004, pp. 268–273.
- [20] —, "A new type of two-stage autonomous pulsed power system using a moving magnet generator as a source of primary power," in *Proc. IX Int. Conf. Megagauss Magnetic Field Generation and Related Topics (Megagauss-9)*, V. D. Selemir and L. N. Plyashkevich, Eds, Sarov, Russia, 2004, pp. 274–278.
- [21] —, "Novel type of explosive driven high-current and high-voltage source of primary power based on longitudinal shock wave demagnetization of Nd₂Fe₁₄B high-energy hard ferromagnet," in *Proc. IX Int. Conf. Megagauss Magnetic Field Generation and Related Topics (Megagauss-9)*, V. D. Selemir and L. N. Plyashkevich, Eds. Sarov, Russia, 2004, pp. 279–285.
- [22] S. C. Shi, C. M. Meng, H. L. He, S. Dong, and F. Zhao, "Design and parameter analysis for explosive-driven demagnetization pulsed power source," *Chin. Phys. Lett.*, vol. 23, no. 2, pp. 423–425, Feb. 2006.
- [23] S. I. Shkuratov, E. F. Talantsev, J. Baird, L. L. Altgilbers, and A. H. Stults, "Compact autonomous explosive-driven pulsed power system based on a capacitive energy storage charged by a high-voltage shockwave ferromagnetic generator," *Rev. Sci. Instrum.*, vol. 77, no. 6, pp. 066107-1–066107-4, Jun. 2006.
- [24] B. A. Jacoby and T. M. York, "High voltage SCR trigger circuit utilizing disc capacitors in a Marx array," *Rev. Sci. Instrum.*, vol. 51, no. 7, pp. 885–890, Jul. 1980.
- [25] C. N. Boyer, G. E. Holand, and J. F. Seely, "Intense nanosecond duration source of 10–250 keV X-rays suitable for imaging projectile-induced cavitation in human cadaver tissue," *Rev. Sci. Instrum.*, vol. 76, no. 3, pp. 035109-1–035109-9, Mar. 2005.
- [26] S. A. Merryman, F. Rose, and Z. Shotts, in *Proc. 13th Int. Pulsed Power Conf.*, 2003, pp. 249–253.
- [27] PSPICE PCB. [Online]. Available: <http://www.pspicepcb.com>



Sergey I. Shkuratov (M'99) was born in Achinsk, Russia, in 1956. He received the M.S. degree in electrical engineering and physics from Tomsk Institute of Automatic Control Systems and Radioelectronics, Tomsk, Russia, and the Ph.D. degree in applied physics from Institute of High-Current Electronics, USSR Academy of Sciences, Tomsk, in 1979 and 1987, respectively.

In 1986, he joined the Institute of Electrophysics, Russian Academy of Sciences, Ekaterinburg, Russia, as a Research Group Leader. He studied electronic properties, atomic structure and transport characteristics of high-temperature superconductors, developed high-temperature superconducting switching devices, and conducted materials research for high efficiency long life time electron emission cathodes for high-power microwave devices. Since 1998, he has been with the Center for Pulsed Power and Power Electronics at Texas Tech University, Lubbock, where he worked as Associate Research Professor. Since 2002, he has been with Loki Inc., Rolla, MO, as a Chief Scientist. His current research interests include explosive pulsed-power and high-power microwaves, limitation of electronic components for portable pulsed-power applications, and nanoscale research and engineering.

Dr. Shkuratov is a member of the American Physical Society. He was a recipient of the USSR Leninsky Komsomol Outstanding Young Scientist Award (1990) and the Paul Chatterton Award (1994).



Evgueni F. Talantsev was born in Kushva, Russia, in 1963. He received the M.S. degree in physics from Urals State University, Ekaterinburg, Russia, and the Ph.D. degree in physics from Institute of Physics of Metals, USSR Academy of Sciences, Ekaterinburg (Sverdlovsk), Russia, in 1986 and 1990, respectively.

In 1986, he was with the Institute of Electrophysics, Russian Academy of Sciences, Ekaterinburg, Russia, where he studied atomic structure, phase transformations, mechanical and emissive properties of metals, ordered alloys, and high-temperature superconductors. In 1998–1999, he worked on the E-beam sterilization project at the University of Missouri–Columbia. In 2000, he worked on the scanning atom probe project at the NanoLab, Kanazawa Institute of Technology, Kanazawa, Japan. Since 2001, he has been with the Center for Pulsed Power and Power Electronics at Texas Tech University, Lubbock, where he was an Assistant Research Professor. Since 2003, he has been with the Loki Inc., Rolla, MO. His current research interests include explosive-driven pulsed-power generators, testing of electronic components for portable pulsed-power applications, and nanoscale research and engineering.



Jason Baird (S'01–M'01) was born at Ramey Air Force Base, Puerto Rico, on December 23, 1955. He received the B.S. degree in engineering sciences (*honor graduate*) from U.S. Air Force Academy, the M.S. degree in aeronautical engineering from U.S. Air Force Institute of Technology, and the Ph.D. degree from University of Missouri, Rolla, in 1978, 1982, and 2001, respectively.

He retired from the U.S. Air Force as a Lieutenant Colonel in 1995; when he retired, he was the Deputy Director of the Missile Propulsion Division of the Propulsion Directorate, Phillips Laboratory, U.S. Air Force. Since then, he has been pursuing studies in energetic materials and shock hydrodynamics at the University of Missouri.



Millard F. Rose (SM'83–F'93) received the M.S. and Ph.D. degrees in engineering physics from Pennsylvania State University.

He is currently the Vice-President for Research and Chief Technical Officer, Radiance Technologies, Inc. Prior to joining Radiance Technology, he was the Director of the Science Directorate at the NASA Marshall Space Flight Center. He is a contributing author/editor of five books, mostly dealing with high-power high-speed phenomena, and is the author of 160 technical papers in the open literature. He holds 12 patents, mostly in the area of advanced energy conversion. He has had a distinguished career involving progressively more responsible experience in performing and managing basic and applied research in the physical sciences and advanced technologies associated with space, shockwave physics, energy conversion, electronic warfare, directed energy technology, and space-power technology.

Dr. Rose is an Associate Fellow of the AIAA and National Associate of the National Academies.



Zachary Shotts received the bachelor's degree in mechanical engineering with a double minor in business and mathematics from Auburn University, Auburn, AL, in 2002.

While a student at Auburn University, he was the construction and transportation foreman for the first Solar Decathlon hosted by the Department of Energy. He is currently employed as a Senior System Engineer for Radiance Technologies, Inc. He is also the Director of the Auburn office, where he is responsible for managing a group of engineers involved in applied research in the fields of hybrid power, robotics, and pulsed power for both directed energy weapons and space propulsion.



Zack Roberts received the degree in chemical engineering, from Auburn University, Auburn, AL, in 2002.

He is currently employed as a Senior Systems Engineer for Radiance Technologies. He is involved in the development of both high voltage and high-current pulsed power for weapons technologies and space propulsion. Before joining Radiance Technologies, he worked as a Plant Startup Engineer for Honda of Alabama.



Larry L. Altgilbers (M'03) received the Ph.D. degree in physics from Semiconductor Physics Institute, Vilnius, Lithuania, where he did research on explosive pulsed power.

He was employed with the U.S. Army Aviation and Missile Command from 1976 to 1991, where he worked on directed energy weapons and various missile systems. Since 1991, he has been employed with the U.S. Army Space and Missile Defense Command, where he initially worked on directed energy weapons, and is now with the Advanced Technology Directorate. His current duties include managing the development of a variety of technologies through the small business innovative research program and the development of pulsed power and radio frequency technologies. He has over 50 conference and journal publications and has published two books: *Magnetocumulative Generators* and *Unconventional Weapons*.

Dr. Altgilbers is currently a member of the American Physical Society and the American Institute of Aeronautics and Astronautics.



Allen H. Stults received the B.S. degree from United States Military Academy (USMA), West Point, New York, the M.B.A. degree from Florida Institute of Technology, and the M.S.E. degree from University of Alabama, Huntsville, AL, in 1979, 1987, and 1998, respectively.

He is the Lead Engineer for multifunctional warheads for the Aviation and Missile Research, Development and Engineering Center, Redstone Arsenal, AL.