

Oct 20th, 12:00 AM

Prediction of Corner Mechanical Properties for Stainless Steels Due to Cold Forming

P. van der Merwe

G. J. van den Berg

Follow this and additional works at: <https://scholarsmine.mst.edu/isccss>



Part of the [Structural Engineering Commons](#)

Recommended Citation

van der Merwe, P. and van den Berg, G. J., "Prediction of Corner Mechanical Properties for Stainless Steels Due to Cold Forming" (1992). *International Specialty Conference on Cold-Formed Steel Structures*. 1. <https://scholarsmine.mst.edu/isccss/11iccfss/11iccfss-session10/1>

This Article - Conference proceedings is brought to you for free and open access by Scholars' Mine. It has been accepted for inclusion in International Specialty Conference on Cold-Formed Steel Structures by an authorized administrator of Scholars' Mine. This work is protected by U. S. Copyright Law. Unauthorized use including reproduction for redistribution requires the permission of the copyright holder. For more information, please contact scholarsmine@mst.edu.

Eleventh International Specialty Conference on Cold-Formed Steel Structures
St. Louis, Missouri, U.S.A., October 20-21, 1992

**PREDICTION OF CORNER MECHANICAL PROPERTIES FOR
STAINLESS STEELS DUE TO COLD FORMING**

by

G.J. VAN DEN BERG¹, P. VAN DER MERWE²

SYNOPSIS

The results of a study of the degree of workhardening on stainless steel Types 304, 409, 430 and Type 3CR12 corrosion resisting steel due to cold work of forming are presented in this paper. Analytical inelastic stress-strain relationships are established for virgin tensile specimens. An equation for predicting the yield strength of corners are developed.

PREDICTION OF CORNER MECHANICAL PROPERTIES FOR STAINLESS STEELS DUE TO COLD FORMING

by

G.J. VAN DEN BERG¹, P. VAN DER MERWE²

SYNOPSIS

Changes in the mechanical properties of steel sheets and plates are brought about by workhardening induced by methods of cold forming, like brake forming and deep drawing. These changes can be an increase in the yield strength and ultimate strength and a decrease in the ductility. Such changes in the mechanical properties depend on the chemical composition of the steel, its prior history of cold work and the type and magnitude of plastic strains caused by the cold work.¹

The results of a study of the degree of workhardening on stainless steel Types 304, 409, 430 and Type 3CR12 corrosion resisting steel due to cold work of forming are presented in this paper. Analytical inelastic stress-strain relationships are established for virgin tensile specimens. The experimental yield strength, ultimate strength and ductility of corners are also determined for the stainless steels in this investigation. These results are used to develop an equation for predicting the yield strength of corners.

MATERIALS CONSIDERED

To develop an equation for predicting the yield strength of corners the materials considered in this investigation were limited to the 2 mm thick sheets. The steels considered are stainless

-
1. Associate Professor, Chairman of Civil Engineering and Chairman of the Materials Laboratory of the Faculty of Engineering at the Rand Afrikaans University. Republic of South Africa.
 2. Professor of Mechanical Engineering and Dean of the Faculty of Engineering at the Rand Afrikaans University. Republic of South Africa.

steel Types 304, 409, 430 and Type 3CR12 corrosion resisting steel.

EQUATION FOR THE INELASTIC PART OF THE STRESS-STRAIN CURVE FOR VIRGIN STEEL

ANALYTICAL MODEL

In a study by Karren^{1,2}, the inelastic part of the stress-strain curve was represented by a power function as given in Equation 1.

$$F = k\varepsilon^n \quad (1)$$

where

F = true stress

ε = true strain

k = strength coefficient

n = strain hardening exponent

When the logarithm of the true strain is plotted against the logarithm of the true stress in the inelastic domain, it appears as a straight line. This is the case for many steels.² It is necessary first to investigate and determine values for k and n experimentally before Equation 1 is used.

EXPERIMENTAL PROCEDURE

Ten uniaxial tensile test specimens were prepared from the 2 mm sheet from various positions of the sheet for stainless steels Type 304, 409, 430 and Type 3CR12 corrosion resisting steel in the longitudinal direction. The tensile test specimens were prepared in accordance with the specifications outlined in ASTM Standard A370-77.³

Tensile tests were conducted generally in accordance with the procedures outlined by ASTM Standard A370-77.³ Average strain was measured with an Instron automatic extensometer using a 50 mm gauge length. A detailed discussion on the determination of mechanical properties can be found in Reference 4.

EXPERIMENTAL RESULTS

The data was converted to true stress and true strain and plotted on a log-log scale. The mean values for k and n obtained from all the true stress-strain curves are given in Table 1. Values

for k and n for each test and steel were determined through a process of linear regression. The curve for BS4360 Grade 43 A carbon steel in Figure 1 was drawn by using the log values in Equation 1. The values for k and n were determined from similar equations as Equations 2 and 3 derived by Karren¹ and are also given in Figures 2 and 3. The yield and ultimate strengths used in Equations 2 and 3 for BS4360 Grade 43 A carbon steel were taken from SABS 0162.⁵ One typical curve for each steel is given in Figure 1.

Through a process of linear regression a good approximation for k is found from the nondimensional plot of k/F_y versus F_u/F_y in Figure 2. This leads to Equation 2.

$$k = 2,371F_u + 1,099F_y \quad (2)$$

where

F_y = virgin sheet steel yield strength

F_u = virgin sheet steel ultimate strength

In Figure 3 values of n are plotted against F_u/F_y . Through a process of linear regression n can then be approximated by Equation 3.

$$n = 0,215 \frac{F_u}{F_y} - 0,154 \quad (3)$$

From Equations 2 and 3 it can be seen that the values of k and n tend to increase with an increase in the F_u/F_y ratio.

Equations 1 to 3 are useful in the next section in deriving equations for predicting the tensile yield strength of cold-formed corners. Figures 2 and 3 also show the curves for Type BS 4360 Grade 43A carbon steel. The values for k and n for carbon steel were determined with similar equations given by Karren.^{1,2} The equations are given in Figures 2 and 3.

EQUATION FOR CORNER YIELD STRENGTH.

ANALYTICAL MODEL

It was reported in a study by Karren^{1,2} that the corner yield strength of cold-formed corners may be closely approximated by Equation 4 for values of $R/t < 10$.

$$F_{yc} = \frac{kb}{(R/t)^m} \quad (4)$$

where

- F_{yc} = corner yield strength
- k = strength coefficient
- R = inside corner radius
- t = thickness of material
- m = constant
- b = constant

When Equation 4 is expressed in terms of logarithms, Equation 5 is found. This approximates a straight line.

$$\log\left(\frac{F_{yc}}{k}\right) = \log b - m \log\left(\frac{R}{t}\right) \quad (5)$$

It was further found by Karren^{1,2} that the relationships between the constants b and n and between m and n are linear. Empirical equations will be derived for b and m in the following paragraphs.

PREPARATION OF SPECIMENS

From each 2 mm sheet of stainless steel Type 304, 409, 430 and Type 3CR12 corrosion resisting steel, ten strips, each 500 mm long and 100 mm wide, were cut with a guillotine in the longitudinal direction. The ten strips from each sheet were bent to different inside corner radii. The smallest inside radius was not less than the thickness of the material. The inside radii of all the specimens were determined by using an electronic profile projector.

Karren^{1,2} found that the effect of cold-forming in the corner extends beyond the corner to a distance approximately equal to the thickness of the material. The portion of the original specimen used for the tension and compression test specimens is shown in Figure 4. The corners were sawn from the bent strips with a bandsaw and subsequently machined on a surface grinder to the required finish and dimensions. The lengths of the tension test specimens were 300 mm and the lengths of the compression test specimens were 70 mm.

The cross sectional area of the corner test specimens were determined by first determining the mass. With the mass per unit volume known, the cross sectional area of the specimens could be determined.

EXPERIMENTAL PROCEDURE

The tension corner test specimens were taken longer than the flat specimens to minimize the effect of the grips on the middle portion. The grips tend to crush the ends of the specimens. The tension tests were conducted in a self aligning Instron universal testing machine. The strain in the tension and compression test specimens were measured with one electric strain gauge mounted on the outside corner of the specimen. Karren^{1,2} used a similar procedure.

Overall buckling of the compression test specimens were prevented by placing the specimen in a specially manufactured compression test fixture. To minimize resistance and the Poisson effect on the lateral strain of the compression test specimen, the fixture and specimen were well greased. Because only a small lateral load is necessary to prevent overall buckling of the test specimen the bolts to keep the fixture together were tightened by hand only.

EXPERIMENTAL RESULTS

The experimental results of the tests on the ten test specimens for each of the four steels are given in Tables 2 to 5. The main effect of the cold-forming on the corners is clear. An increase in the yield strength, F_y , an increase in the ultimate strength, F_u , and a decrease in elongation is observed with a decrease in corner radius.

ANALYTICAL EQUATION

To determine a general equation for the constants b and m , values for b and m were first determined from the experimental data obtained in the previous paragraphs. For each of the four steels the log values of R/t were plotted against the log values of F_y/k in Equation 5 on a log-log scale as shown in Figures 5 to 8. The slope of the best fit straight line gives the appropriate value for m and the intersection with the ordinate gives the corresponding value for b . Values for m and b were obtained through a process of linear regression and are given in Table 6.

As discussed previously, Karren^{1,2} found that the relationships between b and n and between m and n are linear. This is confirmed in this study. See Figures 9 and 10. Through a process of linear regression the following two general equations are obtained for b and m .

$$b = -1,689 n + 0,959 \quad (6)$$

$$m = 0,277 n + 0,073 \quad (7)$$

The curves for carbon steel were drawn by using the equations derived by Karren.¹ These curves and equations for carbon steel are also shown in Figures 9 and 10.

DESIGN EQUATIONS

The Cold-Formed Steel Design Manual⁶ uses Equation 8 to evaluate the increase in corner yield strength, F_{yc} .

$$F_{yc} = \frac{B_c F_y}{(R/t)^m} \quad (8)$$

where

- B_c = constant
- F_y = yield strength of the virgin steel
- R = inside bend radius
- t = thickness of the material

From Equations 3 and 7 Equation 9 for m can be determined.

$$m = 0,060 \frac{F_u}{F_y} + 0,031 \quad (9)$$

From Equations 4 and 8 it can be seen that.

$$B_c = \frac{kb}{F_y} \quad (10)$$

If Equations 2, 3 and 6 are substituted in Equation 10, Equation 11 for B_c can be determined.

$$B_c = 3,289 \frac{F_u}{F_y} - 0,861 \left(\frac{F_u}{F_y} \right)^2 - 1,340 \quad (11)$$

Equations 8, 9 and 11 are in the same format as the equations used in the Cold-Formed Steel Design Manual.⁶

DISCUSSION OF RESULTS

It is clear that with the aid of Karren's work^{1,2} and this study, that the corner yield strength, F_y , can now successfully be related to the R/t ratio and to the material constants k and n .

This study was limited to ratios of $R/t > 2$ and $R/t < 7$ and for corners bent to 90° . The ratios of F_u/F_y were between 1,57 and 2,27.

CONCLUSIONS

The curves for stainless steels in Figures 1, 2, 3 and 9 compare well with the corresponding curves for carbon steel. Although Equation 7 obtained in Figure 10 gives good results, the curve for stainless steel judged visually does not compare well with that of carbon steel. The author feels that more tests should be done for stainless steels with higher F_u/F_y ratios before these equations can be used with confidence.

ACKNOWLEDGEMENTS

The authors would like to acknowledge the financial assistance received from International Chromium Development Association.

REFERENCES

1. Karren, K.W; Corner Properties of Cold-Formed Steel Shapes. Journal of the Structural Division, ASCE. Vol. 93 No. ST1. February 1967.
2. Karren, K.W; The Effects of Cold-Forming on the Mechanical Properties of Structural Sheet Steel. Report No. 317. Department of Structural Engineering. Cornell University. September 1964.
3. American Society for Testing and Materials. Standard Methods and Definitions for Mechanical Testing of Steel Products. ASTM A370-77. Annual Book of ASTM Standards. 1981.
4. Van den Berg, G.J; The Torsional Flexural Buckling Strength of Cold-Formed Stainless Steel Columns. D.Eng Thesis, Rand Afrikaans University, Johannesburg, South Africa. November 1988.
5. South African Bureau of Standards. Code of Practice for the Structural Use of Steel SABS 0162 - 1984.
6. American Iron and Steel Institute. Cold-Formed Steel Design Manual. 1986.

TABLE 1 VALUES FOR k AND n FOR CERTAIN TYPES OF STAINLESS STEELS

STEEL TYPE	F_y	F_u	k	n
304	295,0	671	1267,4	0,334
409	223,9	395	667,8	0,217
430	304,2	518	851,1	0,194
3CR12	276,6	435	747,4	0,187

TABLE 2 MECHANICAL PROPERTIES FOR STAINLESS STEEL TYPE 304 CORNER SPECIMENS

R/t	TENSION SPECIMENS				COMPRESSION	
	F_y (MPa)	F_p (MPa)	F_u (MPa)	Elong %	F_y (MPa)	F_p (MPa)
1,99	451,9	262,8	775	47,1	487,9	230,9
2,22	424,7	222,7	762	50,0	447,3	190,9
3,40	407,3	202,6	759	52,0	468,3	213,5
3,43	396,5	198,1	744	53,0	448,7	237,9
4,43	398,1	193,5	753	55,3	415,4	206,5
4,47	374,0	177,7	-	-	404,2	206,9
5,75	362,4	174,0	730	56,6	403,4	193,0
5,85	358,4	164,7	725	58,0	393,7	209,6
6,63	365,7	174,0	732	57,5	408,4	182,0
7,03	-	-	-	-	398,3	201,6
Flat	295,0	187,9	671	58,6	301,5	166,1

TABLE 3 MECHANICAL PROPERTIES FOR STAINLESS STEEL TYPE 409 CORNER SPECIMENS

R/t	TENSION SPECIMENS				COMPRESSION	
	F _y (MPa)	F _p (MPa)	F _u (MPa)	Elong %	F _y (MPa)	F _p (MPa)
1,80	370,2	200,4	431	29,0	382,3	206,5
1,87	373,5	199,6	431	31,0	384,8	205,3
3,00	364,6	194,2	424	32,4	376,7	195,2
3,26	353,4	187,2	418	38,8	378,8	193,7
4,20	349,6	180,3	420	34,6	379,3	218,7
4,31	334,0	171,9	412	38,0	363,0	192,3
5,36	327,9	167,6	409	40,5	354,3	196,1
5,97	316,6	165,4	403	42,9	336,8	203,9
6,24	321,6	155,7	405	42,9	354,8	202,1
7,09	304,5	174,1	399	43,9	331,7	210,3
Flat	224,3	166,6	389	40,5	229,6	166,5

TABLE 4 MECHANICAL PROPERTIES FOR STAINLESS STEEL TYPE 430 CORNER SPECIMENS

R/t	TENSION SPECIMENS				COMPRESSION	
	F _y (MPa)	F _p (MPa)	F _u (MPa)	Elong %	F _y (MPa)	F _p (MPa)
1,94	470,8	258,7	574	20,2	-	-
2,39	487,9	248,6	583	20,5	496,3	261,1
3,12	458,4	231,9	564	24,9	476,2	202,8
3,53	-	-	-	-	478,9	221,0
4,32	451,3	238,1	560	19,3	476,7	233,8
4,61	442,2	242,2	553	-	465,5	241,5
5,30	435,1	231,1	551	28,0	460,1	247,4
6,09	414,6	177,4	547	32,5	430,5	228,3
6,54	417,7	189,8	548	26,0	465,4	233,1
7,27	407,4	194,7	548	28,9	461,0	246,8
Flat	312,3	214,8	513	30,0	287,4	168,0

TABLE 5 MECHANICAL PROPERTIES FOR TYPE 3CR12 STEEL CORNER SPECIMENS

R/t	TENSION SPECIMENS				COMPRESSION	
	F _y (MPa)	F _p (MPa)	F _u (MPa)	Elong %	F _y (MPa)	F _p (MPa)
1,61	422,7	239,6	508	26,0	467,5	246,4
2,25	449,9	240,0	518	19,0	470,6	220,4
3,08	437,4	227,3	506	26,0	456,6	237,7
3,16	419,8	211,8	497	27,6	447,5	178,1
4,09	408,5	216,7	496	29,4	449,5	234,2
4,33	392,3	198,2	493	30,3	421,9	241,6
5,10	370,6	182,0	482	32,8	410,5	229,5
5,64	378,6	187,1	484	34,4	410,6	210,4
6,25	395,7	272,6	486	31,2	418,1	197,3
6,70	371,0	206,6	487	31,4	41,4	216,8
Flat	276,6	199,3	435	36,1	279,1	195,3

TABLE 6 VALUES FOR k, n, b AND m

PROPERTY	TYPE OF STEEL			
	304	409	430	3CR12
F _y	295,0	224,3	312,3	276,6
F _u	671	389	513	435
F _u /F _y	2,27	1,73	1,64	1,57
k	1267,4	667,8	851,1	747,4
n	0,334	0,217	0,194	0,187
b	0,395	0,617	0,622	0,636
m	0,178	0,139	0,125	0,121

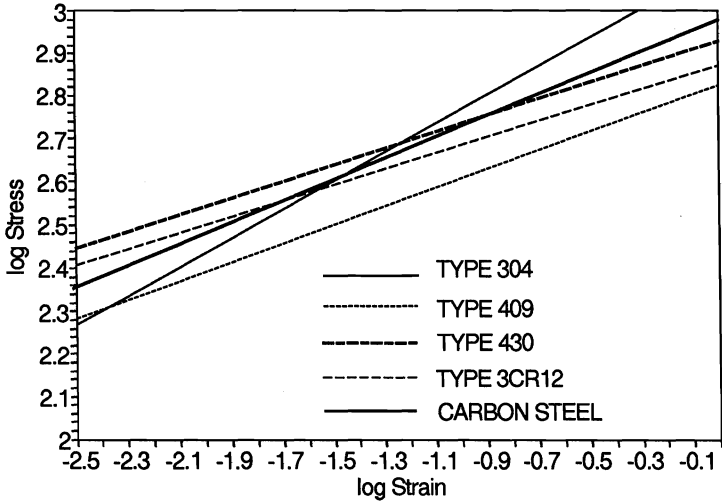

FIGURE 1 TYPICAL LOG STRESS-LOG STRAIN CURVE FOR DIFFERENT STAINLESS STEELS

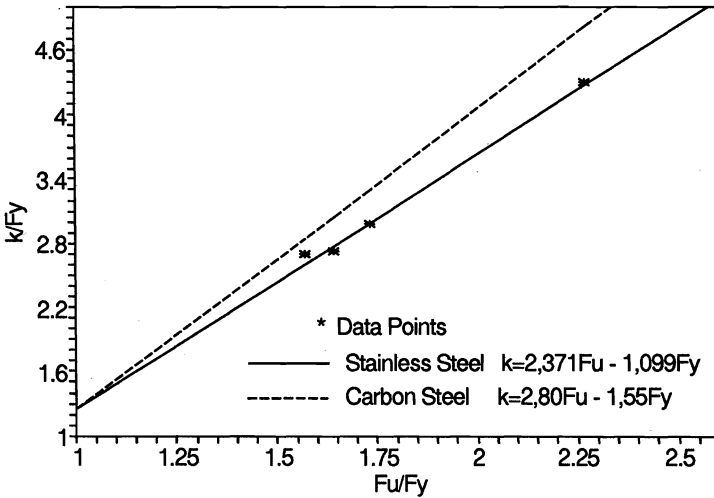

FIGURE 2 k AS A FUNCTION OF YIELD AND ULTIMATE STRENGTHS

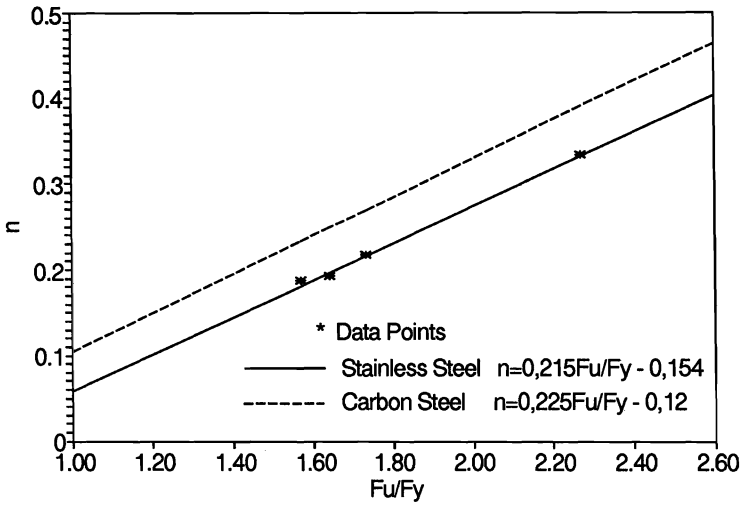

FIGURE 3 n AS A FUNCTION OF YIELD AND ULTIMATE STRENGTHS

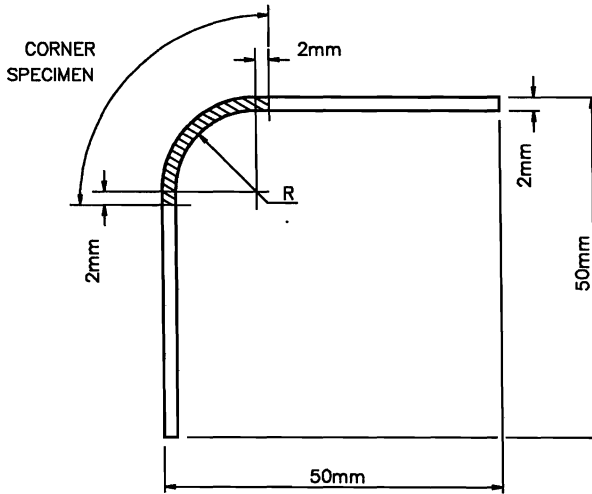

FIGURE 4 CROSS SECTION OF CORNER SPECIMEN

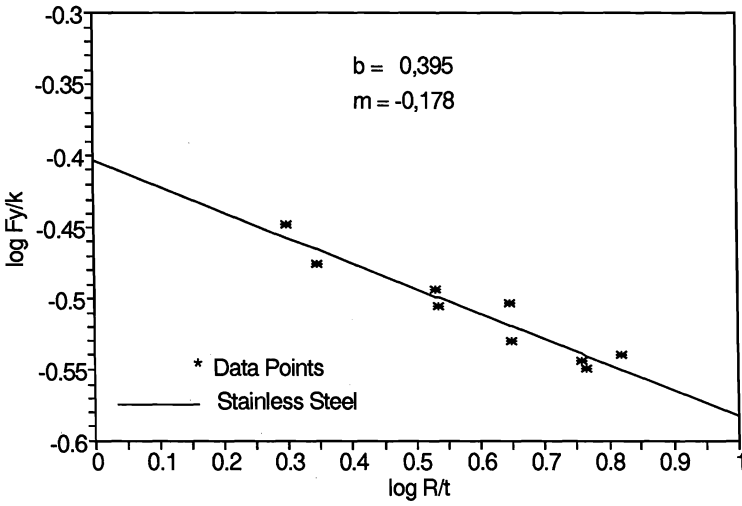

FIGURE 5 CORNER YIELD STRENGTH AS A FUNCTION OF b , k , m AND R/t FOR STAINLESS STEEL TYPE 304

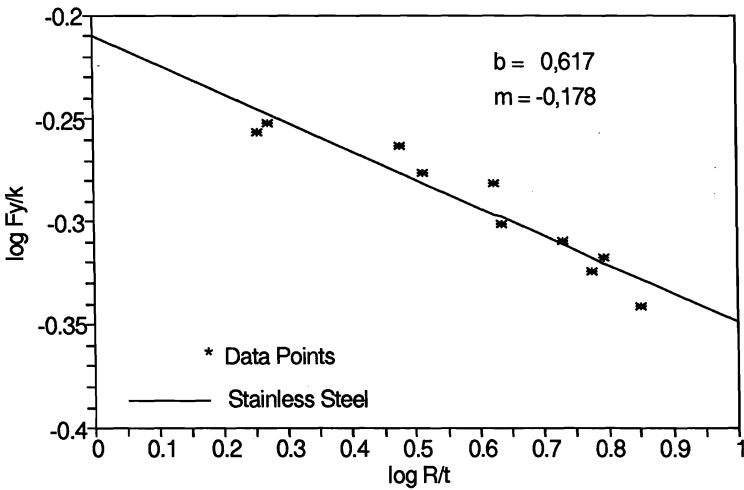

FIGURE 6 CORNER YIELD STRENGTH AS A FUNCTION OF b , k , m AND R/t FOR STAINLESS STEEL TYPE 409

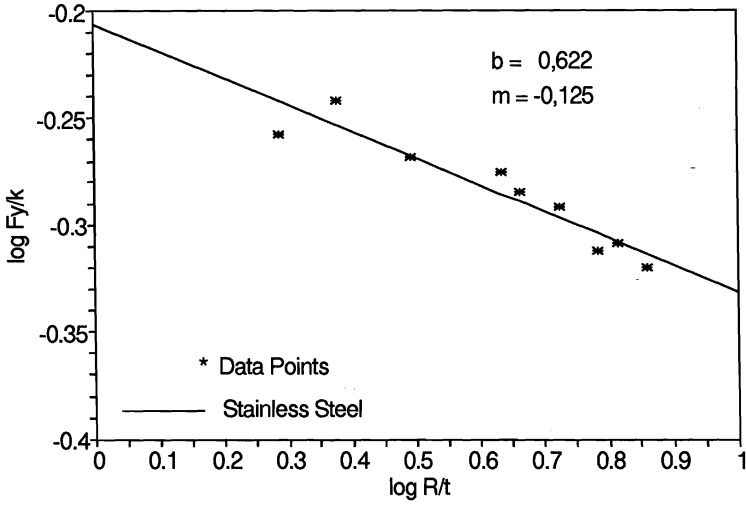

FIGURE 7 CORNER YIELD STRENGTH AS A FUNCTION OF b , k , m AND R/t FOR STAINLESS STEEL TYPE 430

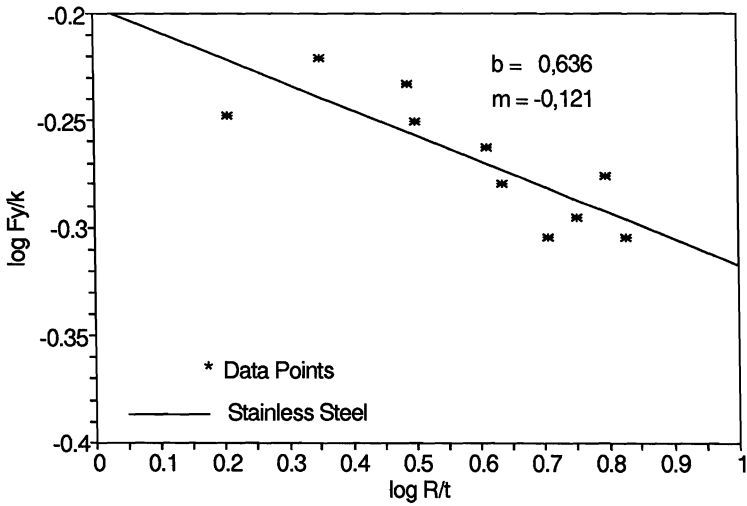
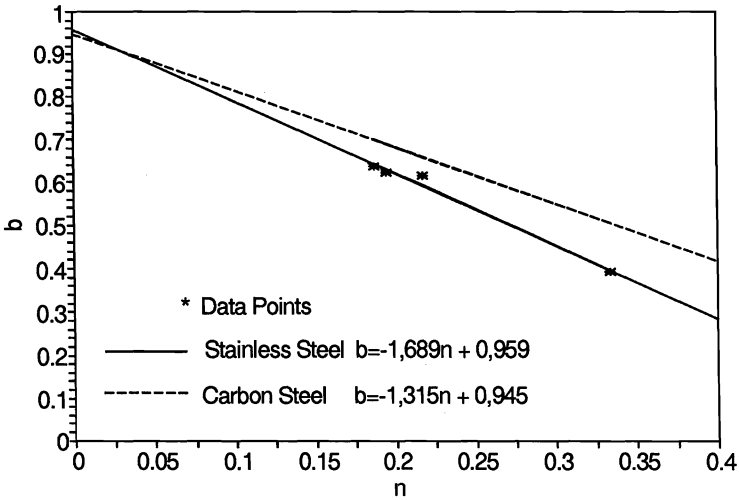
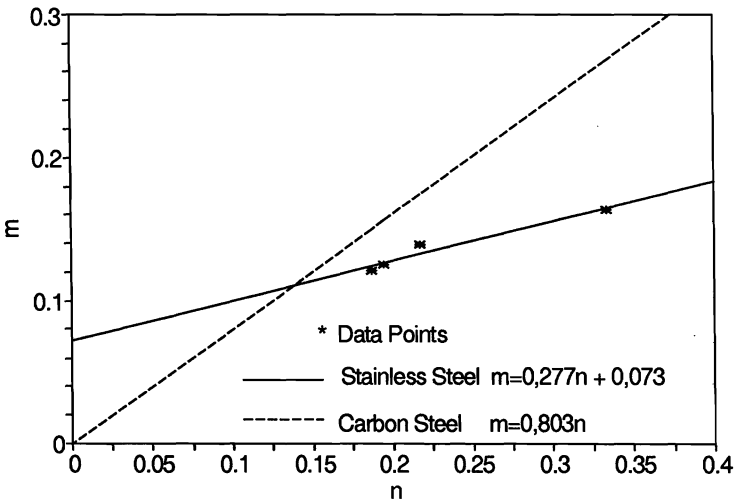

FIGURE 8 CORNER YIELD STRENGTH AS A FUNCTION OF b , k , m AND R/t FOR TYPE 3CR12 STEEL

FIGURE 9 GENERAL EQUATION FOR b FIGURE 10 GENERAL EQUATION FOR m