

research report

Reinforcement Schemes for CFS Joists Having Web Openings

RESEARCH REPORT RP08-6

2008



American Iron and Steel Institute



Steel Framing Alliance™

Steel. The Better Builder.

DISCLAIMER

The material contained herein has been developed by researchers based on their research findings and is for general information only. The information in it should not be used without first securing competent advice with respect to its suitability for any given application. The publication of the information is not intended as a representation or warranty on the part of the American Iron and Steel Institute, Steel Framing Alliance, or of any other person named herein, that the information is suitable for any general or particular use or of freedom from infringement of any patent or patents. Anyone making use of the information assumes all liability arising from such use.

PREFACE

The *Standard for Cold-Formed Steel Framing - Prescriptive Method for One and Two Family Dwellings*, AISI S230-07, as well as other industry span and load tables are based on the standard web openings (i.e., punchouts), as defined in the *North American Standard for Cold-Formed Steel Framing - Product Data*, AISI S201-07. Presented in this report are the findings from an extensive testing program conducted at McMaster University on full-scale floor joists having larger web openings. Presented is an initial Final Report (86 pages) that was issued by the researcher in March 2007, as well as the results of Additional Testing (7 pages) that was received from the researcher in April 2008.

It is anticipated that the results of this study will be incorporated in future standards developed by the AISI Committee on Framing Standards and design aids developed by the Cold-Formed Steel Engineers Institute.

REINFORCEMENT SCHEMES FOR COLD-FORMED STEEL JOISTS HAVING WEB OPENINGS

ADDITIONAL TESTING

SUBMITTED BY:

K.S. (Siva) Sivakumaran, Ph.D., P.Eng.
Member, Centre for Effective Design of Structures,
Professor, Department of Civil Engineering,
McMaster University,
Hamilton, Ontario, CANADA L8S 4L7
Tel: [905]525-9140 Ext: 24814
Fax: [905]529-9688
E-mail: siva@mcmaster.ca

April 2008

SUMMARY

The tables in this report include the results of additional testing of 12-inch and 8-inch depth joists, and are intended to supplement the final report on “*Reinforcement Schemes for Cold-Formed Steel Joists Having Web Openings*” by K.S. (Siva) Sivakumaran, dated March 2007.

In the transmittal of the tables to AISI, the researcher noted that a single 43-mil channel on the compression edge of an 800S162-43 joist with a 5-inch circular hole would suffice, as would a single 43-mil channel on the compression edge of a 1200S162-97 joist with a 6-inch circular hole or double 54-mil channels on the compression edge of a 1200S162-97 joist with a 9-inch circular hole. However, it was noted that double channels would likely be difficult to install.

Pending further testing, the researcher suggested that joists having up to 6-inch circular openings can be adequately reinforced with a single 43-mil channel fastened to compression edge of the opening with screws spaced at 1-inch.

Table 1 Flexural strength of CFS joists with and without web opening in pure flexural zone
 Section Designation: 1200S162-97
 $h/t = 118$

Nominal Moment Capacity (AISI-2001), $M_n = 21.41 \text{ kN-m}$



Test Designation	Moment at Opening Region (kN-m)	Percentage Reduction in Moment Capacity	Sample Pictures	Remarks
F-N	Test 1: 22.94 Test 2: 23.63 Test 3: 22.97 Average: 23.18 Standard Deviation: 0.39	0.00 %		Compression flange local buckling at mid-span
F-C	Test 1: 19.90 Test 2: 19.44 Test 3: 19.80 Average: 19.71 Standard Deviation: 0.24	-14.97 %		Opening Size 9" (75 % of web) Compression flange and web local buckling at opening location mid-span
F-S	Test 1: 17.29 Test 2: 17.67 Test 3: 18.36 Average: 17.77 Standard Deviation: 0.54	-23.34 %		Opening Size 9" (75 % of web) Compression element acted as column buckling

Table 2 Trial stages to develop the reinforcement schemes for pure flexural zone
 Section Designation: 1200S162-97
 $h/t = 118$



Reinforcement Detailing	Sample Pictures	Observation
<p>Stage 1:</p> <p>Reinforced by 1- 1/2" x 1/2" – 54 mils bridging channel section with “d/4” (2.25 inch) screw spacing above and below the square hole.</p> <p>d = width of the square hole</p>		<p>Observation: Began with local buckling on compression flange and web between the screws.</p> <p>Possible Solution: Decrease the spacing of the screws.</p>
<p>Stage 2:</p> <p>Reinforced by 1- 1/2" x 1/2" – 54 mils bridging channel section with “w” (1.25 inch) screw spacing above and below the square hole</p> <p>w = flat width of the web above/below the square hole</p>		<p>Observation: The compression element above the opening acted as a column. A column buckling action on compression element was observed.</p> <p>Possible Solution: Increase the size of the reinforcement to increase over all flexural stiffness of the compression element.</p>
<p>Stage 3:</p> <p>Reinforced by 1- 1/2" x 1/2" – 54 mils bridging channel section with “w” (1.25 inch) spacing above and below the circular hole</p> <p>w = flat width of the web above/below the circular hole</p>		<p>Observation: The compression element above the opening acted as a column. A column buckling action on compression element was observed.</p> <p>Possible Solution: Increase the size of the reinforcement to increase over all flexural stiffness of the compression element.</p>

Table 3 Flexural strength of CFS joists with reinforced circular web opening in pure flexural zone
 Section Designation: 1200S162-97
 $h/t = 118$

Nominal Moment Capacity (AISI-2001), $M_n = 21.41 \text{ kN-m}$



Test Designation	Moment at Opening Region (kN-m)	Percentage Reduction in Moment Capacity	Sample Pictures	Remarks
F-CR_A Matching Plate Reinforcement	Test 1: 21.77 (one test only)	-6.08%		Opening Size 9" (75 % of web) Local buckling on opening region
F-CR_B Matching Stud Reinforcement	Test 1: 22.42 (one test only)	-3.28 %		Opening Size 9" (75 % of web) Local buckling on opening region
F-CR_C Matching (97 mils) Bridging Channel Reinforcement	Test 1: 24.20 Test 2: 24.05 Test 3: 22.89 Average: 23.71 Standard Deviation: 0.04	+2.29 %		Opening Size 9" (75 % of web) Local buckling out of reinforced region

Table 4 Flexural strength of CFS joists with reinforced square web opening in pure flexural zone
 Section Designation: 1200S162-97
 $h/t = 118$

Nominal Moment Capacity (AISI-2001), $M_n = 21.41 \text{ kN-m}$







Test Designation	Moment at Opening Region (kN-m)	Percentage Reduction in Moment Capacity	Sample Pictures	Remarks
F-SR_A Matching Plate Reinforcement	Test 1: 18.39 (one test only)	-20.66 %		Opening Size 9" (75 % of web) Local buckling on opening region
F-SR_B Matching Stud Reinforcement	Test 1: 21.07 (one test only)	-9.10 %		Opening Size 9" (75 % of web) Local buckling on opening region
F-CRC Matching (97 mils) Bridging Channel Reinforcement	Test 1: 23.39 Test 2: 23.55 Test 3: 24.05 Average: 23.66 Standard Deviation: 0.04	+2.07 %		Opening Size 9" (75 % of web) Local buckling out of reinforced region

Table 5 Flexural strength of CFS joists with reinforced circular web opening in pure flexural zone (**Scheme-II with bridging channel**)

Section Designation: 800S162-43 and 1200S162-97

Test Designation	Moment at Opening Region (kN-m)	Percentage Reduction in Moment Capacity	Sample Pictures	Remarks
<p>800S162-43 F-CRC-II Matching (43 mils) Bridging Channel Reinforcement only on Compression side</p>	Test 1: 4.86 Test 2: 4.51 Test 3: 4.65 Average: 4.67 Standard Deviation:0.18	+6.13 %		Opening Size 5" (64 % of web) Local buckling out of reinforced region
<p>1200S162-97 F-CRC-II Two Bridging Channels (54 mils , inside and outside) Reinforcement only on Compression side</p>	Test 1: 24.42 Test 2: 24.12 Test 3: 24.28 Average: 24.27 Standard Deviation:0.15	+4.70 %		Opening Size 9" (75 % of web) Local buckling out of reinforced region
<p>1200S162-97 F-C50RC-II One Bridging Channel (43 mils) Reinforcement only on Compression side</p>	Test 1: 24.03 Test 2: 24.06 Test 3: 23.76 Average: 23.95 Standard Deviation:0.17	+3.40 %		Opening Size 6" (50 % of web) Local buckling out of reinforced region

REINFORCEMENT SCHEMES FOR COLD-FORMED STEEL JOISTS HAVING WEB OPENINGS

FINAL REPORT

SUBMITTED BY:

K.S. (Siva) Sivakumaran, Ph.D., P.Eng.
Member, Centre for Effective Design of Structures,
Professor, Department of Civil Engineering,
McMaster University,
Hamilton, Ontario, CANADA L8S 4L7
Tel: [905]525-9140 Ext: 24814
Fax: [905]529-9688
E-mail: siva@mcmaster.ca

SUBMITTED TO:

Dr. Steve Fox
Canadian Sheet Steel Building Institute
CSSBI - ICTAB
652 Bishop St. N., Unit 2A
Cambridge, Ontario N3H 4V6
CANADA
Tel: (519) 650-1285
Fax: (519) 650-8081
E-mail: sfox@cssbi.ca

March 2007

ACKNOWLEDGEMENTS

Funding for this project was jointly provided by the Canadian Sheet Steel Building Institute, American Iron and Steel Institute, and the Steel Framing Alliance. The cold-formed steel sections and the bridging channels used in the tests were provided by the Canadian Sheet Steel Building Institute. Involvement and the contributions of Dr. Steve Fox, Ph.D., Manager, Canadian Sheet Steel Building Institute, and of Dr. Nabil A. Rahman, Ph.D.,P.E., Director of Engineering & Research Division, The Steel Network, Inc. throughout the project are gratefully acknowledged. Tests were conducted at the laboratory facilities of the Department of Civil Engineering, McMaster University, by Mr. Sandesh Acharya (Ph.D. Candidate) with the assistance from Mr. Paul Heerama (UROP-Undergraduate Student). Parts of the investigation presented in the report will form parts of the Ph.D. dissertation to be written by Mr. Sandesh Acharya. Special thanks to the civil engineering laboratory technical staff Mr. Maurice Forget, Mr. David Perrett, Mr. Peter Koudys and Mr. Bernard Nieuwehuis for their invaluable assistance in conducting the tests reported herein. Thanks also to Mr. Rob Lemmon, Department of Materials Engineering, who assisted with tension coupon tests, and to others who assisted the principal investigator in many different capacities.

SUMMARY

The use of Cold-Formed Steel (CFS) members has become increasingly popular in small to medium size building construction, including house construction. In order to keep the floor height of these structures to a minimum, the floor joists of such structures may use large web openings, which can provide the necessary pass through space for ductwork, piping, drainage and other similar systems. A cost effective way to alleviate the detrimental effects of a large web opening is to affix appropriate reinforcements around the opening regions, so as to restore the original strength and stiffness of the member. The overall objective of this research is to develop functional, effective and economical reinforcement schemes for cold-formed steel (CFS) lipped channel floor joists having large web openings. The goal is to develop reinforcement schemes that would restore the original strengths and stiffness of the joists, so that the original design of the joist need not be changed. The experimental investigation presented in this report considered cold-formed steel lipped channel sections having 43 mils (1.092 mm) thickness and 8 inches (203.2 mm) web depth. Based on nine tensile coupon test results, the yield strength of the test sections ranged between 304 and 317 MPa, whereas the ultimate strength values ranged between 393 and 406 MPa (50ksi=345MPa).

A total of twenty three 9 feet (2743mm) long laterally braced cold-formed steel joist sections were simply supported and subjected to uniformly distributed loads until failure (flexural tests). These tests considered solid sections, sections with unreinforced web openings and sections with reinforced web openings. Circular and square web openings (65% of web depth) were considered in this study. The objective of this part of the experimental investigation was to assess the effectiveness of three different reinforcement schemes for flexural zones. These are the key observations based on these flexural tests; [1] The reduction in the flexural strength of a cold formed steel joist section due to a large web opening (up to 65% of web height) is less than 15%. [2] The reinforcement schemes “A”, “B”, and “C” considered in this study can restore the flexural strength of cold formed steel joist sections having a large web opening.

A total of twenty seven cold-formed steel (CFS) joist sections were subjected to short span shear tests [914mm (36”) short span, with mid-span point load], which established the shear resistances of such sections having a large web opening, and having a reinforced web opening. The

investigation once again focused on circular and square web openings (opening depth is 65% of the flat width of the web). This investigation considered 43mils (1.092 mm) thick, 8” (203.2 mm) deep joist sections only. The test program included three types of reinforcement schemes; two schemes prescribed by the current Standard for Cold-Formed Steel Framing- Prescriptive Method for One and Two Family Dwellings (AISI, 2004) and the third scheme consisted of a Virendeel truss type reinforcement arrangement for high shear zone. These are the key observations based on these shear tests; [3] Short Span Shear Test: Short span specimen subjected to single mid-span load experiences high shear as well as high moment at the load location. Thus, this test setup simulates the high shear zones, as well as high shear-high moment conditions that exist at the over-the-support location in a continuous span joist. [4] The reduction in the shear strength of a cold-formed steel joist section, in the presence of high moments and due to the presence of a large web opening (up to 65% of web height), may be as high as 60%. In other words, the residual shear strength of a joist with a large opening may be as low as 40%. [5] The reinforcement schemes “A”, and “B”, established as per AISI (2004) patching requirements, are not adequate to restore the shear strengths of joist sections with opening. [6] The reinforcement scheme “C”, Virendeel type reinforcement system, for web opening is capable of restoring the original shear strength of a cold-formed steel joist section.

The flexural zone and shear zone for a joist member depend on the structural arrangement and the loadings. The last chapter of this report establishes definitions for the flexural zone and shear zone for cold-formed steel joists and prescribes appropriate reinforcement schemes for the corresponding zones. Based on analysis of joist having different structural arrangements and subjected to uniformly distributed loads, the following observations were made; [7] Noting that, in general, the shear resistance ($V_{\text{resistance}}$) of a CFS joist designed based on governing moments is greater than the peak shear force due to corresponding uniformly distributed loads, and assuming that the reduction in the shear strength of a CFS joist section due to a large web opening (up to 65% of web height) would be less than 50%, it is observed that the for all possible structural arrangements, the shear force within the mid 40% region of a joist (0.30L and 0.70L) will be less than 50% of the shear resistance of the joist. Thus the openings in the mid 40% region of a joist will not need the shear reinforcements, however, such openings will need the flexural reinforcements. [8] Since the shear forces outside the mid 40% region of a joist (0.30L and 0.70L) may be more than 50% of the shear resistance of the joist, and may be subjected to high

moments, openings located in regions outside the mid 40% of the joist will need the shear reinforcements. [9] Since the shear forces within the mid 40% region of a joist (0.30L and 0.70L) is less than 50% of the shear resistance of the joist shear reinforcements are not needed. However, since the moments within the mid 40% region of a joist (0.30L and 0.70L) is more than 85% of the moment resistance of the joist, openings located in regions within the mid 40% of the joist will need the flexural reinforcements.

Based on these studies it was concluded that; The mid 40% region of a joist (0.30L and 0.70L) can be defined as “Flexural Zone”, and will need flexural reinforcements for openings in this region. The regions outside the mid 40% region of a joist (0.30L and 0.70L) can be defined as “Shear Zone”, and openings located in regions outside the mid 40% of the joist will need the shear reinforcements.

The following reinforcement details are proposed for the shear zones and for the flexural zones.

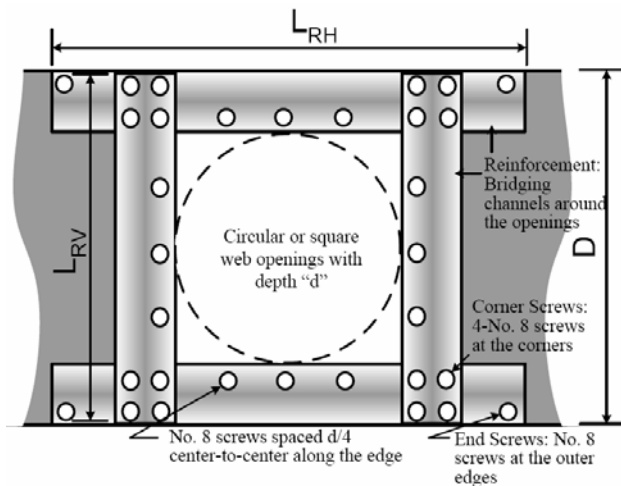

Reinforcement Schemes for Shear Zone

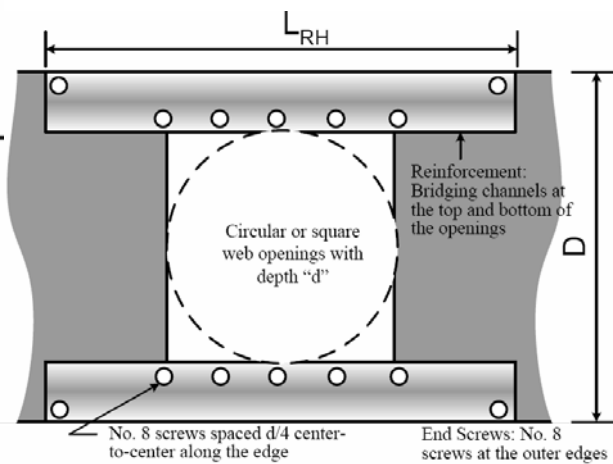
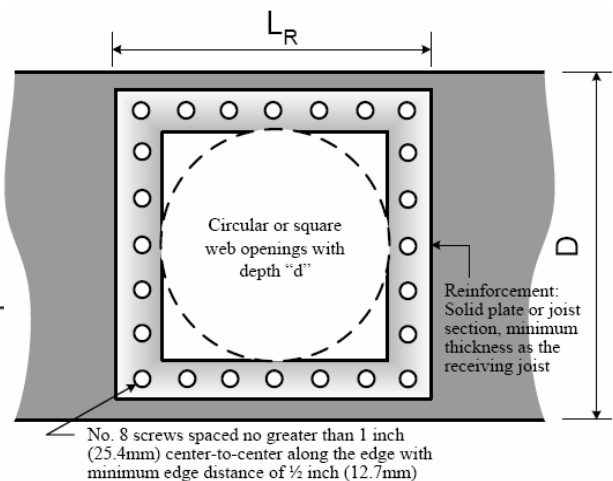

Reinforcement Schemes for Flexural Zone

TABLE OF CONTENTS

	Contents	Page
	ACKNOWLEDGEMENTS	ii
	SUMMARY	iii
	TABLE OF CONTENTS	vi
	LIST OF TABLES	vii
	LIST OF FIGURES	viii
1.0	INTRODUCTION	1-1
1.1	Overview	1-1
1.2	Past Relevant Studies on CFS Members with Openings	1-2
1.3	Objectives and Scopes	1-6
1.4	Cold-Formed Steel Joists – Test Specimens	1-7
2.0	FLEXURAL STRENGTH OF JOISTS WITH WEB OPENINGS	2-1
2.1	Overview	2-1
2.2	The Flexural Test Setup	2-1
2.3	The Flexural Strength of Joist with Large Web Opening	2-4
2.4	The Flexural Strength of Joist with Reinforced Web Opening	2-6
3.0	SHEAR STRENGTH OF JOISTS WITH WEB OPENINGS	3-1
3.1	Overview	3-1
3.2	The Shear Test Setup	3-1
3.3	The Shear Strength of Joist with Large Web Opening	3-4
3.4	The Shear Strength of Joist with Reinforced Web Opening	3-6
4.0	REINFORCEMENT SCHEMES FOR JOIST HAVING WEB OPENINGS	4-1
4.1	Overview	4-1
4.2	Definition of the “Flexural Zone” and the “Shear Zone”	4-2
4.3	Reinforcement Schemes for Flexural Zones (Mid 40% of the joist)	4-6
4.4	Reinforcement Schemes for Shear Zones (Outside the Mid 40% of the joist)	4-7
5.0	REFERENCES	
	Appendix – A Section Dimensions and Mechanical Properties	A-1

Appendix – B	Flexural Tests	B-1
Appendix – C	Shear Tests	C-1

LIST OF TABLES

Tables	Title	Page
1.1	w/t ratio for common Cold-Formed Steel lipped Channel Section	1-7
1.2	Specified and Measured Section Properties and Mechanical Properties	1-8
2.1	Flexural Strength of CFS joists with and without web opening in high moment regions (Flexural Zone)	2-5
2.2	Flexural Strength of CFS joists with reinforced circular web opening in high moment regions (Flexural Zone)	2-7
2.3	Flexural Strength of CFS joists with reinforced square web opening in high moment regions (Flexural Zone)	2-7
3.1	Shear strength of CFS joists with and without web opening in high shear region (Shear Zone)	3-4
3.2	Shear strength of CFS joists with reinforced circular web opening in high shear region (Shear Zone)	3-7
3.3	Shear strength of CFS joists with reinforced square web opening in high shear region (Shear Zone)	3.7

LIST OF FIGURES

Figures	Title	Page
1.1	Various reinforcement schemes recommended for hot-rolled steel beams (Segner, 1964)	1-3
1.2	Reinforcement schemes for CFS sections tested by Pennock, (2001)	1-4
1.3	Plate and stud reinforcement for CFS sections suggested by AISI (2004)	1-5
1.3	Reinforcement schemes for CFS sections tested by Sivakumaran et al., (2006)	1-5
2.1	The Flexural Test Setup	2-1
2.2	Photograph of the Flexural Test Setup	2-2
2.3	Test Specimen Assembly Cross sections at Locations A and B	2-3
3.1	The Shear Test Setup and the Cross-Section of the Test Specimen Assembly	3-1
3.2	Photograph of the Shear Test Setup	3-3
3.3	Virendeel Reinforcement Scheme	3-6
4.1	Shear Variations on Floor Joist	4-2
4.2	Moment Variation on Floor Joist	4-4
4.3	Reinforcement Schemes for Flexural Zone	4-6
4.4	Reinforcement Schemes for Shear Zone	4-7

1.0 INTRODUCTION

1.1 Overview

The use of Cold-Formed Steel (CFS) members has become increasingly popular in small to medium size building construction, including house construction, perhaps because the cold-formed steel design can be a cost-effective option, as compared to hot-rolled steel or other traditional construction materials such as reinforced concrete, masonry, and wood. Cold-formed steel floor joists are widely used in the floor construction of detached one- and two- family dwellings, townhouses and other attached single-family dwellings. Typical cross section of such joists is a lipped channel shape. In order to keep the floor height of these structures to a minimum, the floor joists of such structures may use large web openings, which can provide the necessary pass through space for ductwork, piping, drainage and other similar systems. Appropriate use of web openings can enhance the aesthetic appeal and can result in efficient construction of cold-formed steel floor systems. The depth of these large web openings, however, can be a substantial proportion of the beam depth. Thus, these large web openings can significantly affect the strength and the failure characteristic of the entire member. Various studies exist on the flexural, shear, web crippling strengths of cold-formed steel sections having a large web opening. The current North American cold-formed steel design standard (AISI, 2001) also provides guidelines to account for the effects of such openings.

However, a cost effective way to alleviate the detrimental effects of a large web opening is to affix appropriate reinforcements around the opening regions, so as to restore the original strength and stiffness of the member. Strategically placed reinforcements for such openings can reestablish the overall capacity of such cold-formed steel members, and can mitigate the detrimental effects of such large web openings. Currently available Cold-formed Steel Design Standard (AISI, 2001) and other steel framing standard (AISI, 2004), however, either do not apply or do not provide adequate guidelines to facilitate the design and construction of reinforcements for floor joists with large web openings. Objectives of this investigation are to establish the effects of a large web opening on the [a] flexural strength and [b] shear strength of cold-formed steel lipped channel shaped floor joists, and then to establish effective and economical reinforcement schemes for such large web openings that would restore the original flexural and the shear strengths of such floor joists.

1.2 Past Relevant Studies on CFS Members with Openings

Various studies exist on the effects of web openings on the strength of cold-formed steel sections (Yu, and Davis, 1973; Sivakumaran and Zielonka, 1989; Shan, et.al, 1994; LaBoube, et.al, 1997; Abdel-Rahman, and Sivakumaran, 1998; Pu, et.al., 1999). In one of the early studies on the strength of members with openings, Hoglund (1971) reported on the flexural strength of statically loaded plate girders containing circular and rectangular holes subjected to transverse loading. The web plates of these girders were slender having w/t values ranging from 200 to 300. In these experiments, the girders with holes in high shear zone failed at significantly lower loads than those in the zone of high bending and low shear. Shan et. al. (1994) carried out experimental and theoretical studies to determine the load carrying capacity of the cold-formed steel flexural members with web elements having openings. A total of forty-one fully braced C-shaped members with web openings under simply supported conditions were subjected to bending moments. This study showed that the buckling behavior of web perforated members is different from the buckling behavior of the original solid members. Schuster et. al. (1995) determined the effects of perforated channel sections in shear. Each test specimen consisted of two channel joist sections strapped together using aluminum angles to form a box beam in order to prevent torsional effects. The web perforations were either diamond or elliptical shaped and the depth of openings varied between 20 and 78 percent of web depth. Results indicated that the presence of web perforations reduce the shear capacity significantly.

Reinforcement of Web Openings

Only a few research studies exist on the reinforcement of cold-formed steel members with large web openings. Studies by Segner (1964) and Copper and Snell (1971) considered the behavior of hot-rolled steel beams with reinforced web holes. Various reinforcement schemes considered by Segner (1964) are shown in Figure 1.1. The reinforcement schemes consisted of horizontal, vertical and inclined bars welded to the web around the openings. The reinforcement of large openings is a widely used construction practice in hot-rolled steel construction, because of the economy and easy of fabrication. These investigations emphasized the ultimate strength analysis of hot-rolled steel beams with web openings. These studies focused primarily on square and rectangular holes, having a particular form of web reinforcement. Redwood and Shrivastava (1980) presented design recommendations for W-shaped hot-rolled beams with and without reinforced holes. Both square and rectangular holes with the height of the openings between 30%-70% of the beam depth were studied.

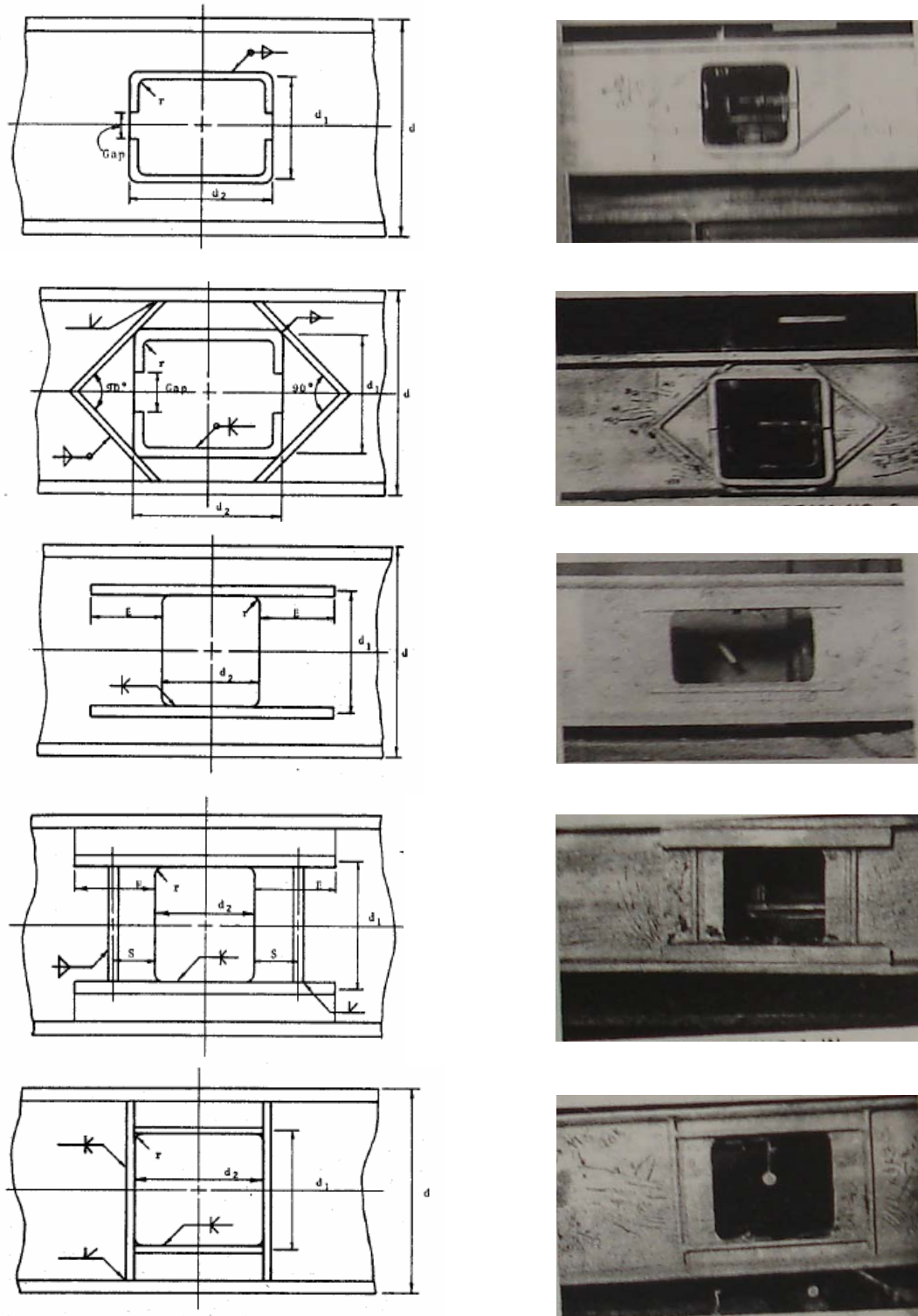

Figure 1.1 Various reinforcement schemes recommended for hot-rolled steel beams (Segner, 1964)

Pennock (2001) conducted an experimental investigation on the strength of cold-formed steel (CFS) joists with large opening. Fifty six specimens were tested under eight point-load configurations. The purpose of this study was not only to determine the effects of large circular openings on the strength of CFS joists, but also to assess the performance of various reinforcement schemes. Most of the test specimens were subjected to bending and combined shear and bending, under simply supported conditions. CFS steel joists with web perforations were tested under two point loading conditions. Circular and square perforations, which reduced the web area by 75 percent were investigated. Load and perforation locations were varied so that the effect of varying levels of moment and shear were evaluated. In the study by Pennock (2001), the web opening was reinforced with a piece of a joist of the same shape and thickness. It was observed that the use of this kind of reinforcement in pure flexure was ineffective in restoring the capacity of joists. The reinforcement schemes tested by Pennock, (2001) are shown in Figure 1.2.

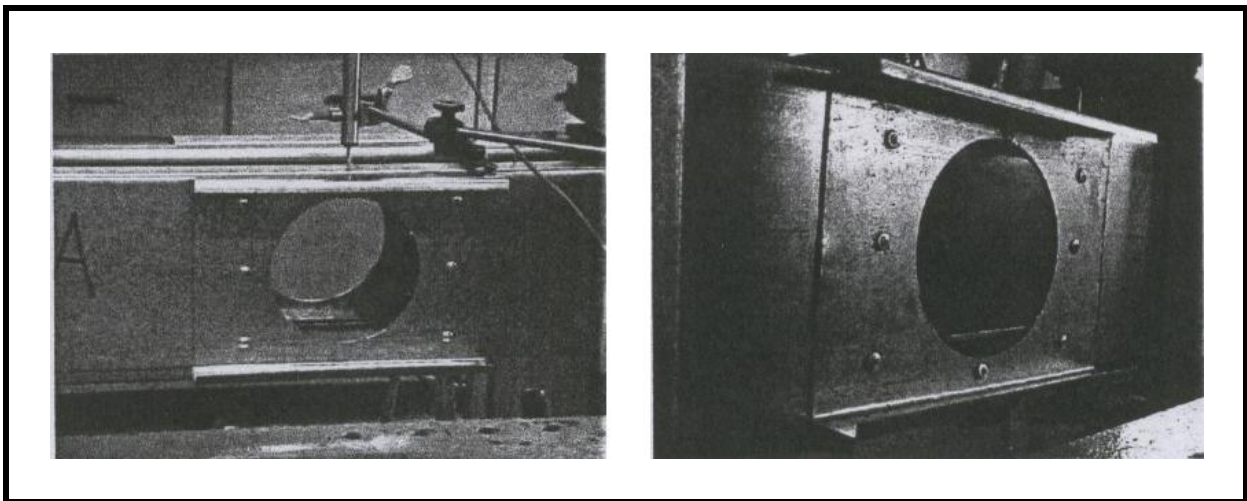

Figure 1.2 Reinforcement schemes for CFS sections tested by Pennock, (2001)

The current Standard for Cold-Formed Steel Framing- Prescriptive Method for One and Two Family Dwellings (AISI 2004) contains recommendations for the reinforcement of web openings in cold-formed steel (CFS) sections. According to this standard the web opening shall be reinforced (patched) with a solid steel plate, stud section or track section. The minimum thickness of such reinforcement shall be equal to the thickness of receiving section, and shall extend 1 inch (25.4mm) beyond all edges of the hole. The steel plate, stud section or track section shall be fastened to the web of the section with No. 8 screws spaced 1 inch (25.4 mm) center-to-center along the edges of the patch with edge distance of $\frac{1}{2}$ inch (12.7 mm). The resulting reinforcement schemes suggested by AISI (2004) are shown in Figure 1.3. No experimental investigations were found in the literature to support these recommendations.

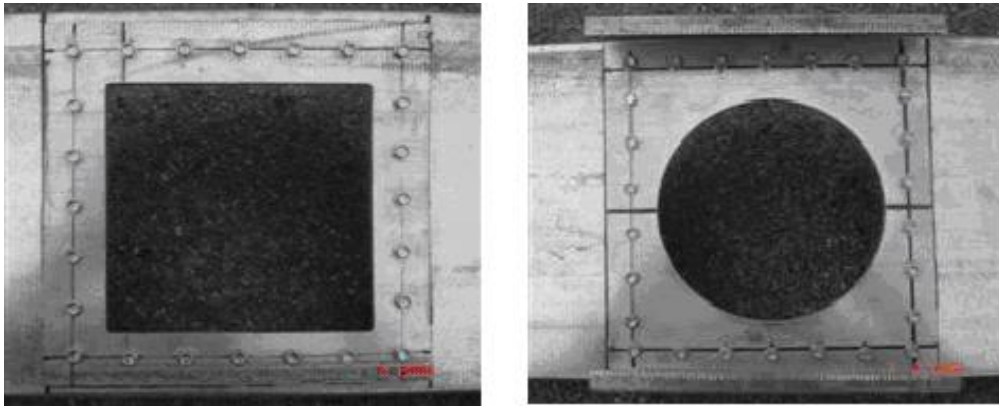

Figure 1.3 Plate and stud reinforcement for CFS sections suggested by AISI (2004)

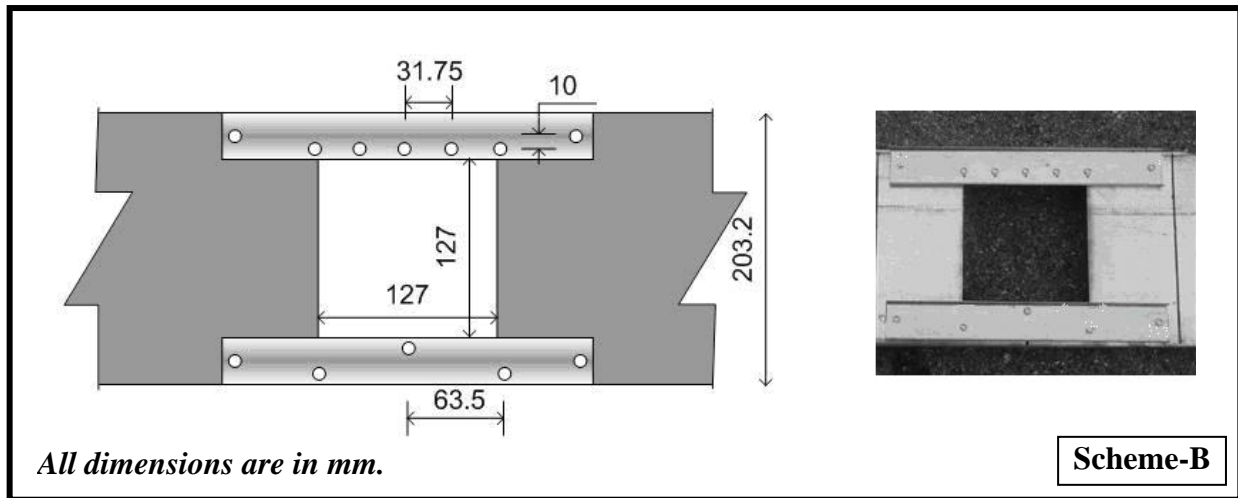
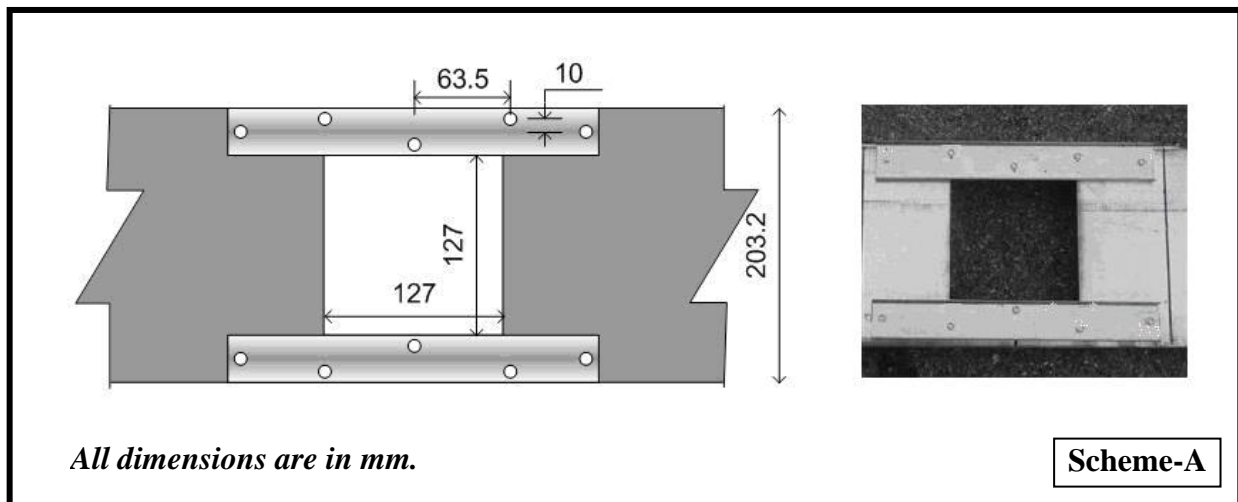

Figure 1.4 Reinforcement schemes for CFS sections tested by Sivakumaran et al., (2006)

Sivakumaran et al., (2006) conducted a study to establish reinforcement schemes for cold-formed steel (CFS) flexural members with web openings. The experimental study considered eleven sets of three identical test specimens. The test consisted of specimens with no web opening, specimens with knock-out opening, specimens with large web opening, and specimens with two different reinforcement schemes. The test program considered large circular, square, and rectangular openings having a height of 66% of the web flat height. Reinforcements were provided on the top and bottom edges of the openings by bridging channels of 38.1 mm web depth and 1.1 mm thickness. Reinforcements were screw fastened using two different screw spacing. The reinforcement schemes tested by Sivakumaran et al. (2006) are shown in Figure 1.4. The study observed that the effectiveness of the reinforcement depends on the reinforcement type and its length, screw spacing and screw pattern. Furthermore, it was determined that if a large web opening is made in the flexural zones of a cold-formed steel joist [a] it may not be necessary to reinforce the tension zones of the web, [b] it is desirable to have closely spaced screws to reduce the possibility of local buckling of the compression edge of the large opening, and [c] it is desirable to screw fasten the reinforcements as close as possible to the compression edges of the opening, in order to minimize edge local buckling. The study established that the reinforcement scheme B was capable of regaining the original flexural strength of the CFS joist sections. Overall, it was evident from the study by Sivakumaran et al., (2006) that it is possible to establish cost-effective reinforcement schemes for cold-formed steel sections having large web openings.

1.3 Objectives and Scopes

The overall objective of this research is to develop functional, effective and economical reinforcement schemes for cold-formed steel (CFS) lipped channel floor joists having large web openings. The goal is to develop reinforcement schemes that would restore the original strengths and stiffness of the joists, so that the original design of the joist need not be changed.

The study has following scopes.

- Establishment of reinforcement schemes for large web openings in flexural zones.
- Establishment of reinforcement schemes for large web openings located in primarily shear zones.
- Determination of definitions for flexural zones and shear zones.

1.4 Cold-Formed Steel Joist – Test Specimens

Since cold-formed steel sections often fail due to local buckling, which is primarily governed by the slenderness (w/t) of elements, the slenderness of the web can be one of the factor that may be used for the selection of joist sizes for the test specimens. Table 1.1 summarizes the w/t ratios for various lipped channel sections that are commonly used in practice.

Table 1.1 w/t ratio for common Cold-Formed Steel lipped channel sections

h t (mils)	6" (152.4mm)	8" (203.2mm)	10" (254mm)	12" (304.8mm)	14" (355.6mm)
43 (1.092mm)	134	180*	-	-	-
54 (1.372mm)	105	142	179	-	-
68 (1.727mm)	82	112	141	170	200
97 (2.464mm)	56	76	97	118	138

In Cold-formed steel (CFS) building construction practice, however, lipped channel section having web depth 8 inches (203.2 mm) is one of the most commonly used floor joist size. Therefore, this section can be a good representative joist for this experimental investigation. However, sections having greater depths are also used in practice. The Standard for Cold-Formed Steel Framing- Prescriptive Method for One and Two Family Dwellings (AISI 2004) standard has provided information on web depth as higher as 12 inches (304.8 mm). In Canadian CFS steel construction practice sections having web depth of 14 inches (355.6 mm) have also been used as floor joist. Hence, section with web depth of 12 inches (304.8 mm) may also be selected for experimental study to represent higher web-depth sections. Section thickness may be selected to represent a wide range of w/t ratios and available thicknesses. This experimental investigation presented in this report however, considered cold-formed steel lipped channel sections having 43 mils (1.092 mm) thickness and 8 inches (203.2 mm) web depth. The specified and the measured sectional properties and the mechanical properties of the sections under consideration are given in Table 1.2.

Mechanical Properties

The mechanical properties of the flat zones of the cold-formed steel sections (i.e. flange and web) were established in accordance with the tensile testing procedures conforming to ASTM Standard Test A370 (ASTM, 2003). Accordingly, three tensile coupons were taken from the flat portions

of three randomly selected CFS sections. For each such section, two coupons were taken from the web and one coupon was taken from one of the flanges, resulting in a total of nine tensile coupons. The mechanical properties of 54mil and 43mil bridging channels (used as reinforcements) were also established. Two tensile coupons were taken from flat portion of web of the bridging channels. Therefore, a total of thirteen (13) tension test specimens were considered in this study. Further details associated with the establishment of sectional and mechanical properties are given in Appendix – A.

Table 1.2 Specified and Measured Sectional Properties and Mechanical Properties

Specified and Measured Sectional Properties and Mechanical Properties		
Properties	Specified	Measured
Web Height - D	203.2 mm	201.5 mm
Flange Width in Compression- B_c	41.1 mm	40.9 mm
Flange Width in Tension- B_t	41.1 mm	40.5 mm
Lip Depth in Compression- d_c	12.7 mm	11.9 mm
Lip Depth in Tension- d_t	12.7 mm	11.6 mm
Coated (Total) Thickness - t'	-	1.15 mm
Base Metal Thickness - t	1.09 mm (43 mils)	1.12 mm
Proportional Limit - F_p	-	280 MPa
Yield Strength - F_y	345 MPa	311 MPa
Ultimate Strength - F_u	420 MPa	401 MPa
Ultimate/Yield Strength – F_u/F_y	-	1.29
Strain at Rupture - ϵ_u	-	$\approx 29\%$

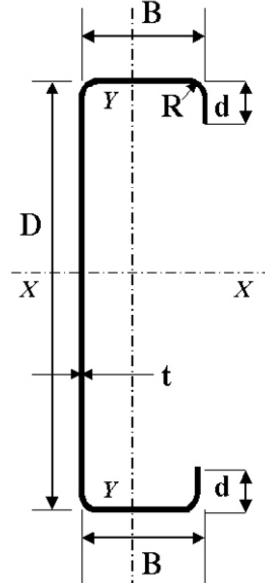

1 inch = 25.4mm, 50ksi=345MPa

Table 1.2 shows the average mechanical properties based on nine tensile coupon test results. The proportional limit values ranged between 247 and 290 MPa, the yield strength values ranged between 304 and 317 MPa, whereas the ultimate strength values ranged between 393 and 406 MPa. The average proportionality limit, yield strength and ultimate strength were 280, 311 and 401 MPa with standard deviation 14, 5 and 5 MPa, respectively. The average ultimate tensile strength to yield strength ratio of about 1.29 with standard deviation 0.01, and the average strain at rupture, which reflects the ductility of the steel, of 29% with standard deviation 2%.

2.0 FLEXURAL STRENGTH OF JOISTS WITH WEB OPENINGS

2.1 Overview

This chapter discusses the flexural strength of cold-formed steel (CFS) joists having a large web opening. A total of twenty three cold-formed steel joist sections [43mils (1.092 mm) thick, 8" (203.2 mm) deep joist sections only] were subjected to flexural tests. These tests considered solid sections, sections with unreinforced web openings and sections with reinforced web openings. Circular and square web openings were considered in this study. The objective of this part of the experimental investigation was to assess the effectiveness of three different reinforcement schemes for flexural zones.

2.2 The Flexural Test Setup

The flexural tests were carried out on 9 feet (2743mm) long simply supported test specimens. Pinned and roller supports were used at the ends of the test specimen. Since, most of the CFS floor joists in practice are expected to carry uniformly distributed load that is transformed from the floor deck, the test setup was designed to produce uniformly distributed loads on the test specimen. Such a uniformly distributed load was assumed have been created by using a series of six identical hydraulic jacks of maximum capacity of 10 ton each, connected to single hydraulic pump. This arrangement results in equal loads on all jacks at all times. Figure 2.1 shows the sketch of the flexural test setup, whereas the Figure 2.2 gives the photograph of the test setup.

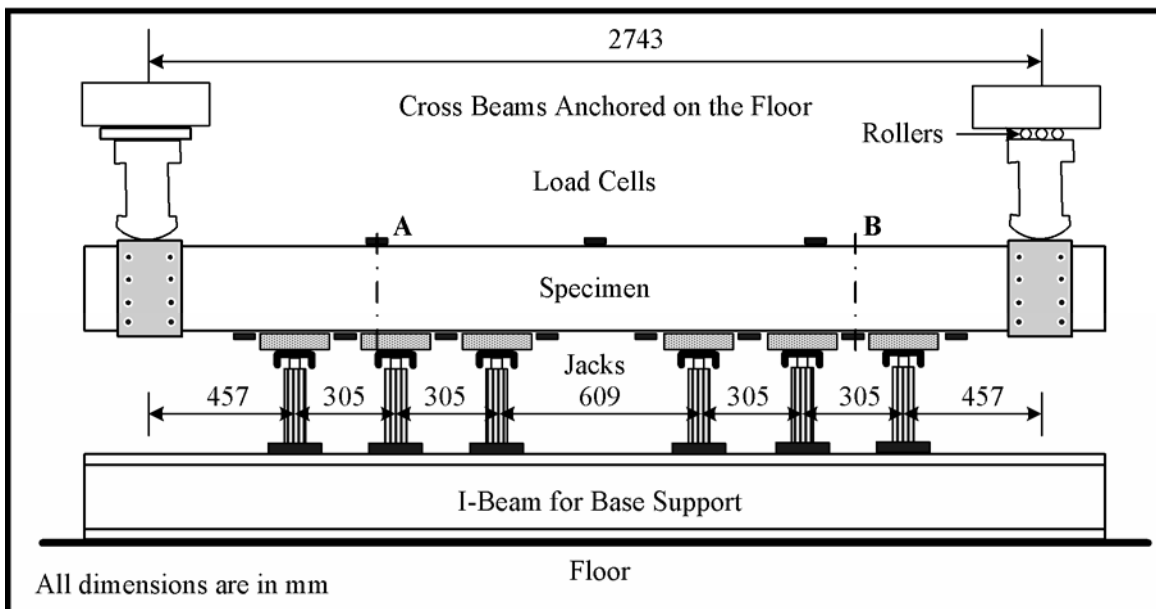

Figure 2.1 The Flexural Test Setup



Figure 2.2 Photograph of the Flexural Test Setup

Each load was transmitted to the test specimen through a 280 mm x 254 mm x 20 mm oriented strand board (OSB). Such loading arrangement would impart an even distribution of load on the specimen thereby minimizing the possibility of web crippling. The applied loads on the hydraulic jacks were monitored through a pressure gauge connected to the hydraulic pump. The total reactions at the end supports were measured using two load cells, which were located on the hot-rolled steel cross-beam at each support. Both cross beams were anchored to the rigid floor below, using two 1-1/2" hot-rolled steel rods. Since the loads were applied vertically upwards supports were anchored downwards through the 2 feet thick reinforced concrete test floor. The ends of the test specimen were laterally supported by angles having smooth vertical face to prevent lateral movement of the ends. Furthermore, in order to prevent lateral-torsional buckling of the test specimens, lateral braces were provided at one-third span locations. Two vertical linear variable displacement transducers (LVDTs) mounted on the top of two sections measured the central vertical displacements of the specimen. Two lateral LVDTs were set to measure the lateral displacements of the web at central region. Lateral displacements were measured at 1-1/2" below from the top flange and 1-1/2" above from the bottom flange. In some tests, four strain gauges were attached to measure the longitudinal strain on the top flange, bottom flange, web at 1-1/2" below from the top flange and web at 1-1/2" above from the bottom flange.

The Test Specimens

The test specimen consisted of two 10 feet long CFS joists assembled front-to-front using two steel brackets at the supporting point. Such steel brackets primarily help transfer the concentrated loads at the supports through the web of the sections, thereby preventing the web crippling

possibility of the sections, due to the high concentrated load. The steel brackets also help hold the sections vertically and face-to-face together. The inner width of these brackets was 140 mm. The test sections were attached to the steel bracket using two lines (four screws in each line) of No. 10 self-drilling screws. The test sections were also connected together using 130 mm x 20 mm x 6.4 mm steel strips, which were located at every 305 mm along the compression flange and at every 686 mm along the tension flange of the test specimen. The steel strips were screw fastened using No. 8 self-drilling screws. The cross-sections of the test specimen assembly at locations A and B are as shown in Figure 2.3. These locations have been identified in Figure 2.1.

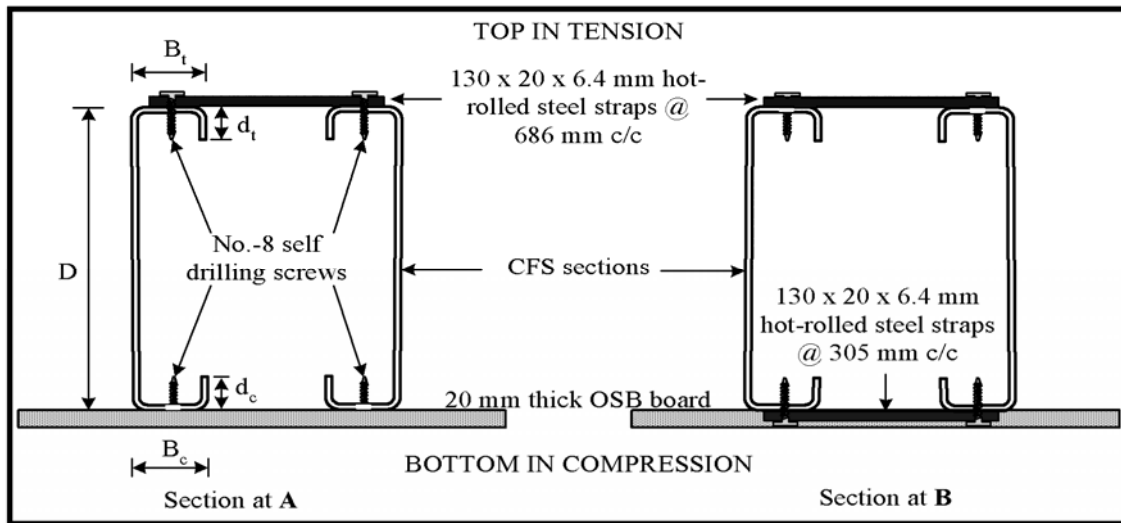

Figure 2.3 Test Specimen Assembly Cross sections at Locations A and B

The Test Procedure

Once the test specimen is placed within the test setup, the longitudinal and lateral levels of the specimen were checked. The span length and the positions of vertical loads were measured and recorded. The tightness of lateral supports and verticality of lateral supporting plates were checked. The load cells, LVDTs and strain gauges readings were initialized to zero. Then, the load was applied gradually using a hydraulic pump. The loading rate was controlled such that the support shear increased at 1.0 kN per minute. Loading rate was selected such that: (a) sufficient load increments can be recorded for graphing the load-displacement relations (60 readings per kN of support shear) (b) stress rate at any point of the section does not exceed the stress rate specified by ASTM for tensile coupon test (690 MPa/min). Frequently, the loading was stopped for few minutes in order for the specimens and the loads to reach equilibrium positions. The load cells, LVDTs and the strain gauges readings were recorded using a computerized data acquisition system. The loading was continued until the load drops to 70% of the failure load.



2.3 The Flexural Strength of Joist with Large Web Opening

The first part of the investigation considered the flexural strength of [a] sections with no openings, [b] sections with a large circular opening, and [c] sections with a large square opening. Three identical tests were done for each case, thus, this part included nine tests. The maximum size of the opening for use was determined on the basis of minimum space requirement for reinforcement arrangement. A bridging channel section having 1-1/2" web depth was considered as potential element to be used as reinforcement. These bridging channels are easily available in cold-formed steel construction. Therefore, 1-1/2" spacing was needed to be left on the top and bottom of the web openings, which left a 5" web in the middle. Circular and square openings with 127mm (5") diameter and side, respectively, were considered for the study. The opening depth considered herein is 64.6% of the flat width of the web, and these openings were located at the centre of the test specimen span. Water-jet cutting was used to fabricate these large web openings.

The Table 2.1 summarizes the flexural strength of cold-formed steel joists with and without a web opening in the flexural zone. Test designation F-N indicates the flexural strength with no opening. Based on three identical tests, the load displacement relations were consistent. The support reactions on both supports were observed to be the same at every load step. Based on the average of two support reactions, the peak support reactions were established as 11.72 kN, 11.46 kN and 11.46 kN. The moment capacity of the joist was established based on these load readings and based on the distance measurements. The average moment capacity of a single section based on these tests is 4.40 kN-m. The calculated moment capacity of the section based on AISI (2001) design provisions is 4.35 kN-m. It was observed that the failure was initiated with the distortion of the flange however, in the end the specimen failed due to local buckling of compression flange and web. All three specimens failed at the centre region (maximum moment region). Detail test results and photographs of the failed specimens are also given in Appendix B.

The Table 2.1 also presents the flexural strength of joists with a circular opening. Three identical specimens exhibited consistent load displacement relations, and failure modes, which are given in Appendix B. The peak support reactions associated with these specimens were 11.08 kN, 11.06 kN and 10.42 kN. The average moment capacity of single section based on these support reaction was established as 4.13 kN-m. A large circular web opening reduced the moment capacity by 6.13%.

Table 2.1 Flexural strength of CFS joists with and without web opening in high moment regions (Flexural Zone)

Test Designation	Moment at Opening Region (kN-m)	Percentage Reduction in Moment Capacity	Sample Pictures	Failure Mode
F-N	Test 1: 4.47 Test 2: 4.37 Test 3: 4.37 Average: 4.40 Standard Deviation: 0.06	0.00 %		Compression flange local buckling at mid-span
F-C	Test 1: 4.22 Test 2: 4.21 Test 3: 3.97 Average: 4.13 Standard Deviation: 0.14	-6.13 %		Compression flange and web local buckling at opening location mid-span
F-S	Test 1: 3.68 Test 2: 3.92 Test 3: 3.75 Average: 3.78 Standard Deviation: 0.12	-14.09 %		Compression flange and web local buckling at opening location mid-span

1 kN.m = 8.85 kips.inch

The test results for specimens with square web openings presented in Table 2.1 are based on three identical tests. The average moment capacity of cold formed sections with 65% square web opening was determined to be 3.78 kN-m, which is 14.09% less compared to a solid section. Once again, the associated detailed results are given in Appendix B. Sivakumaran et al. (2006) also studied the impact of web opening on the flexural resistance of cold formed steel joist sections. Their experimental investigation considered 1.89 mm (74mils) thick, 203.2 mm (8") deep joist sections [$w/t \approx 100$] having 127mm (5") circular and square opening, and 127mm x 254mm (5" x 10") rectangular opening. Based on three identical tests Sivakumaran et al. (2006) concluded that the reduction in moment capacity due to these web openings ranges from 9.6% to 12.3%.

Key Observation: 1

The reduction in the flexural strength of a cold formed steel joist section due to a large web opening (up to 65% of web height) is less than 15%.

2.4 The Flexural Strength of Joists with Reinforced Web Opening

The second part of the investigation considered reinforced web openings. Five tests considered the flexural strength of sections with reinforced circular opening, whereas nine tests considered the reinforced circular openings. Three different reinforcement schemes were considered.

Reinforcement Scheme - A (AISI, 2004)

This scheme is the AISI (2004) specified patching scheme, where the web openings were reinforced with a solid steel plate having the same size and the shape of openings. The thickness of the steel plate was equal to the thickness of receiving section (43mil) and extended 1 inch (25.4mm) beyond all edges of the hole. The reinforcement was fastened to the web with No. 8 screws spaced 1 inch (25.4 mm) center-to-center along the edges of the patch with edge distance of ½ inch (12.7 mm).

Reinforcement Scheme - B (AISI, 2001)



In this scheme, the web openings were reinforced (patched) with a CFS joist sections having same size and shape of openings. The thickness of the reinforcement was equal to the thickness of receiving section (43mils) and extended 1 inch (25.4mm) beyond all edges of the hole. The joist reinforcement was fastened to the web of the section with No. 8 screws spaced 1 inch (25.4 mm) center-to-center along the edges of the patch with edge distance of ½ inch (12.7 mm).

Reinforcement Scheme - C (Present Study)

The reinforcement scheme-C involves screw fastening (No. 8 self-drilling screws) of bridging channels (depth 1-1/2 inch, thickness 43mils) of length determined by width of the opening plus one half of the depth of the opening on either side and plus a minimum edge distance for screws (10mm). As a result, the total length of the reinforcements was 274 mm. The reinforcement scheme-C for flexural zone consisted of two bridging channels, one along the top edge of the opening, and the other along the bottom edge of the opening. The bridging channels were screw fastened along the edges of the opening (1/2inch from the edge) at a spacing of 31.75 mm ($d/4$, where d is depth of the openings).



Single tests were carried out for each of scheme “A” and “B” reinforcements for circular web openings, however, three identical tests were conducted for other four cases. The detailed test results including the load-displacement relations and the photographs of the failures are given in Appendix B, thus, not repeated herein. However, the Tables 2.2 and 2.3 summarize the moment resistances of the cold-formed steel sections with reinforced web opening.

Table 2.2 Flexural strength of CFS joists with reinforced circular web opening in high moment regions (Flexural Zone)

Test Designation	Moment at Opening Region (kN-m)	Percentage Reduction in Moment Capacity	Sample Pictures	Failure Mode
F-CR_A Plate Reinforcement (Scheme- "A")	Test 1: 4.59 (one test only)	+4.31 %		Compression flange and web local buckling out of reinforced region
F-CR_B Stud Reinforcement (Scheme- "B")	Test 1: 4.58 (one test only)	+4.09 %		Compression flange and web local buckling out of reinforced region
F-CR_C Bridging Channel Reinforcement (Scheme- "C")	Test 1: 4.60 Test 2: 4.59 Test 3: 4.66 Average: 4.62 Standard Deviation: 0.04	+5.00 %		Compression flange and web local buckling out of reinforced region

1 kN.m = 8.85 kips.inch

Table 2.3 Flexural strength of CFS joists with reinforced square web opening in high moment regions (Flexural Zone)

Test Designation	Moment at Opening Region (kN-m)	Percentage Reduction in Moment Capacity	Sample Pictures	Failure Mode
F-SR_A Plate Reinforcement (Scheme- "A")	Test 1: 4.59 Test 2: 4.66 Test 3: 4.57 Average: 4.61 Standard Deviation: 0.05	+4.77 %		Compression flange and web local buckling out of reinforced region
F-SR_B Stud Reinforcement (Scheme- "B")	Test 1: 4.31 Test 2: 4.67 Test 3: 4.63 Average: 4.53 Standard Deviation: 0.20	+2.95 %		Compression flange and web local buckling out of reinforced region
F-CR_C Bridging Channel Reinforcement (Scheme- "B")	Test 1: 4.69 Test 2: 4.45 Test 3: 4.48 Average: 4.54 Standard Deviation: 0.13	+3.18 %		Compression flange local buckling out of reinforced region

1 kN.m = 8.85 kips.inch

Eight tests were carried out following the AISI (2004) reinforcement (hole-patching) requirements. Plate reinforcement (scheme “A”) and the stud reinforcements (scheme “B”) were considered for both circular and square holes. However, since the square holes present a worse case situation, only single tests were conducted for the cases of plate and stud reinforcement on circular openings. As shown in Tables 2.2 and 2.3, three identical tests were considered for all other cases. Detail results are given in Appendix –B. All the specimens containing reinforcement scheme “A” failed at locations other than the opening location. Furthermore, the reinforced sections carried about 5% higher moments at the reinforced opening locations. This indicates that the reinforcement scheme “A” is capable of restoring the flexural strengths of joist sections with opening. Based on the test results associated with scheme “B”, similar observations can be made on the reinforcement scheme “B”.

Tables 2.2 and 2.3 also give the moment resistances of scheme “C” reinforced sections having circular and square opening. Once again, the specimens with reinforcement scheme “C” failed at locations outside the opening and reinforcement. The failure mode can be described as local buckling of flange and web. The reinforcement scheme “C” in a circular opening produced peak moments of 5% more than the moments observed in the solid joist sections. Similarly, reinforcement scheme “C” in a square opening resisted moments of 3% more than the peak moments observed in solid joist sections. Thus, it can be stated that the reinforcement scheme “C” is capable of restoring the original flexural strength of a cold-formed steel joist section. Even though, all three reinforcement schemes seem to be capable of restoring the flexural strength of CFS joists having web openings, scheme “C” is easy, simple and economical to construct compared to scheme “A” and “B”. The reinforcement scheme “C” can be easily fastened to joist in place.

Key Observation: 2

The reinforcement schemes “A”, “B”, and “C” considered in this study can restore the flexural strength of cold formed steel joist sections having a large web opening.

3.0 SHEAR STRENGTH OF JOISTS WEB OPENINGS

3.1 Overview

This chapter discusses the experimental investigation on the shear strength of cold-formed steel (CFS) solid sections, sections with unreinforced web openings, and sections with reinforced web openings. The investigation once again focused on circular and square web openings. The test program included three types of reinforcement schemes; two schemes prescribed by the current Standard for Cold-Formed Steel Framing- Prescriptive Method for One and Two Family Dwellings (AISI, 2004) and the third scheme consisted of a Vierendeel truss type reinforcement arrangement for high shear zone. The objective of the experimental investigation was to assess the effectiveness of three reinforcement schemes for CFS steel joists having web openings in high shear zone. A total of twenty seven cold-formed steel (CFS) joist sections were subjected to short span shear tests, which established the shear resistances of such sections having a large web opening, and having a reinforced web opening. This investigation considered 43mils (1.092 mm) thick, 8” (203.2 mm) deep joist sections only.

3.2 The Shear Test Setup

This section describes the experimental set-up, and the configurations of test specimens. Figure 3.1 shows the sketch of the test setup used in this investigation. It is impossible to create a pure shear zone for “shear testing” because of the presence of a moment whenever there is shear force. In practice though, a shear test is performed by creating a high shear and low moment region.

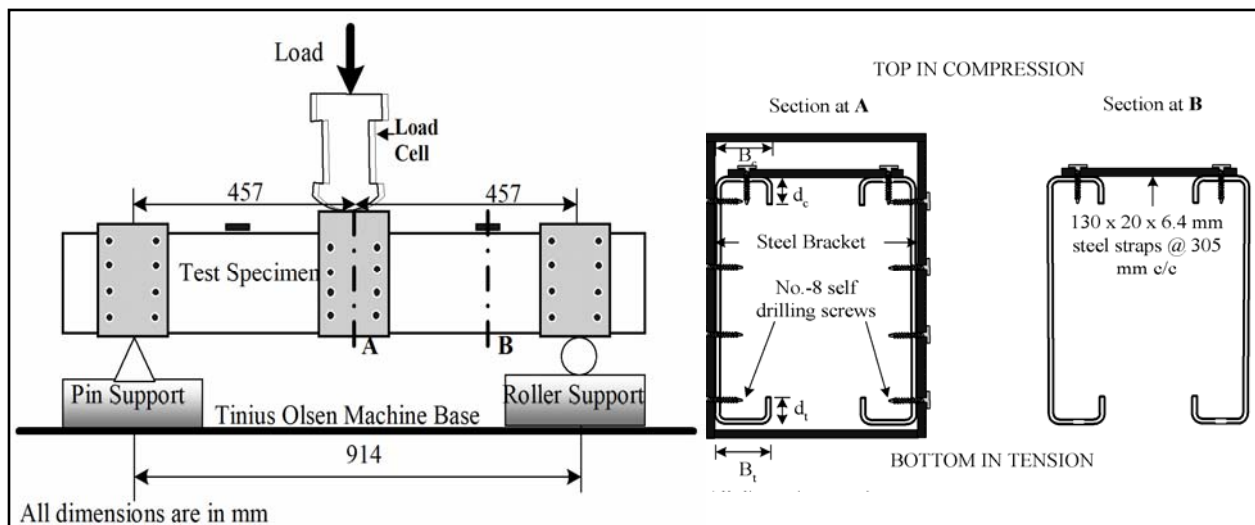

Figure 3.1 The Shear Test Setup and the Cross-section of the Test Specimen Assembly

Here, a 914mm (36") short span, with mid-span point load was considered as an appropriate test setup to achieve high uniform shear and low moments. One end of the test specimen was pin-supported, whereas the other end was roller-supported in order to allow for any horizontal movements. The test arrangement as described above, and as shown in Figure 3.1, results in uniform shear forces and increasing moments between the support and the mid-span load point. The load was applied at the centre of the span using the 600kN capacity Tinius Olsen test machine. The concentrated loads at the load point and at the supports may cause web-crippling failure, prior to the anticipated shear failure. In this investigation, as shown in Figure 3.1, the load from the machine, and the support reactions were transmitted to the web of the specimen through steel brackets. Furthermore, the vertical planes of the steel brackets were fastened to the webs of the test specimens using self-drilling screws, which was to help transfer the concentrated loads effectively into the web. The Figure 3.1 also shows the cross-sectional configurations of the test specimens. The investigation considered mono-symmetric 203.2mm (8") deep 1.092 mm (43mils) thick galvanized lipped channel CFS sections. Mono-symmetric section is generally liable to torsional loadings, due to the fact that the shear center does not coincide with the centroid of the section. However, it is not convenient to apply a load through the shear center of a single channel section, as its shear center is outside of the section. Therefore, in this investigation two lipped channel sections with a length of about 1220 mm (48") were set face-to-face to form the test specimen. In this arrangement the torsional effects are counterbalanced by each other, since torsional restraints were provided at several locations utilizing different elements. The steel brackets that were used to prevent web crippling at the load and the support locations provide some torsional restraints at these locations. In addition, 6mm (1/4") thick steel plate strips were attached to the non-bearing flanges at load and at support locations which enhanced the torsional resistance at these locations. Furthermore, additional steel plate strips were fastened to the compression flanges of the two sections of the test specimen at about 304 mm (12") intervals. Two vertical linear variable displacement transducers (LVDTs) were mounted on the top of two sections to measure central vertical displacement of the specimen. Two lateral LVDTs also were set to measure lateral displacement of the web at central region. Lateral measurements were measured at 38mm (1-1/2") below from the top flange and 38mm (1-1/2") above from the bottom flange. Four strain gauges were used in some of the tests which were attached to measure longitudinal strain on the top flange, bottom flange, web at 38mm (1-1/2") below from the top flange and web at 38mm (1-1/2") above from the bottom flange. Figure 3.2 is the photograph of the shear test setup.



Figure 3.2 Photograph of the Shear Test Setup



The Test Procedure

At first, the longitudinal and transverse centerlines of the whole test set-up were checked, so that the specimen's centerlines coincide with the corresponding centerlines of the loading machine and the end supports. Otherwise, the loads might not be applied in a symmetrical manner as intended. Then the span length and the position of the central load were measured and recorded. Each specimen was first trial loaded to low load levels, which when repeated one or two times ensured proper functioning of the load cells and transducers. After this trial loading, the load cells, the displacement transducers and the strain gauge readings were initialized to zero. Now the loading can begin and the load was applied gradually. The loading rate was controlled such that the total load increases by 2.0 kN per minutes. This loading rate was selected such that (a) sufficient load increments can be recorded to establish adequate load-displacement relationship (b) stress rate at any point of the section does not exceed the stress rate specified by ASTM for tensile coupon test (690 MPa/min). Prior to testing, the possible shear capacity of the section was estimated based on North American Specification for the Design of Cold-Formed Steel Structural Members-S-136-01 (AISI, 2001) design criteria for shear members. Accordingly, the shear strength of the sections under consideration, with $a/h=1.5$, would be about 9.43kN/section. The loading was paused for 3 minutes at three equal intervals of such estimated shear capacity. Such a break in loading allows the stress to distribute on the entire beam. The readings from the load cells, LVDTs and the strain gauges were recorded to a data file using a data acquisition system and personal computer. The loading was continued until the load drops to 70% of the failure load or until a clear failure shape was evident.

3.3 The Shear Strength of Joist with Large Web Opening

The first part of the investigation considered the shear strength of [a] sections with no openings, [b] sections with a large circular opening, and [c] sections with a large square opening. Three identical tests were done for each case, thus, this part included nine tests. Circular and square openings with 127mm (5")-diameter and 127mm (5")-side, respectively, were considered for the study. The opening depth considered herein is 64.6% of the flat width of the web, and these openings were located at the centre of the test specimen span. Similarly to the flexural test specimens, water-jet cutting was used to cut out these large web openings.

Table 3.1 Shear strength of CFS joists with and without web opening in high shear region (Shear Zone)

Test Designation	Peak Shear at Opening Region (kN)	Percentage Reduction in Shear Capacity	Sample Pictures	Failure Mode
S-N	Test 1: 12.23 Test 2: 12.56 Test 3: 12.49 Average: 12.43 Standard Deviation: 0.17	0.00 %		Primarily shear failure mixed in with flexural failure.
S-C	Test 1: 7.37 Test 2: 7.45 Test 3: 7.48 Average: 7.43 Standard Deviation: 0.06	-40.22 %		Shear diagonal failure
S-S	Test 1: 5.10 Test 2: 5.27 Test 3: 5.06 Average: 5.14 Standard Deviation: 0.11	-58.65 %		Shear diagonal failure

1 kN = 0.225 kip

Detail test results and photographs of the failed specimens related to shear tests are given in Appendix C. The Table 3.1 summarizes the shear strength of steel joists with and without a web opening in the high shear zone. Though, short specimens were used these specimens experience high shear and high moments at the load location. Test designation S-N indicates the test specimen with no opening. Based on three identical tests, the load displacement relations were observed to be consistent. Based on three identical tests, the peak shears at the opening regions were established as 12.23 kN, 12.56 kN and 12.49 kN. Therefore the shear capacity of a single joist section based on these tests is 12.43 kN. The calculated shear capacity of the section based on AISI (2001) design provisions is 8.81 kN. Though, shear buckles were evident in these test specimens well prior to failure, the eventual failure of solid specimen was right at the edges of

the loading bracket, indicating that the failure is due to combination of shear and moment. All three identical specimens experienced similar failure modes.

The test results for specimens with circular web openings (Specimens S-C) presented in Table 3.1 are based on three identical tests. It was observed that the failure was governed by diagonal shear buckling of web at the opening region. All three specimens were failed at the region of the opening. The peak shear forces experienced by these sections were 7.37 kN, 7.45 kN and 7.48 kN. The average shear capacity for a single section with a large web opening based on these tests is 7.43 kN. The circular openings reduced the shear resistance by 40.22 %. The test results for specimens with square web openings are also presented in Table 3.1. These specimens also failed due to diagonal shear buckling of web at the opening region, which is evident in the photograph given in Table 3.1. All three specimens failed at the opening region in a similar manner. The peak shears recorded corresponding to one joist section were 5.10 kN, 5.27 kN and 5.06 kN. The average shear capacity of a single 43mils (1.092 mm) thick, 8” (203.2 mm) deep joist, based on three identical tests, is 5.14 kN. The shear capacity of joist section was reduced by 58.65% due to the presence of square openings. The impact of a square hole seems to be more severe than a circular hole.

Key Observation: 3

Short Span Shear Test: Short span specimen subjected to single mid-span load experiences high shear as well as high moment at the load location. Thus, this test setup simulates the high shear zones, as well as high shear-high moment conditions that exist at the over-the-support location in a continuous span joist.

Key Observation: 4

The reduction in the shear strength of a cold-formed steel joist section, in the presence of high moments and due to the presence of a large web opening (up to 65% of web height), may be as high as 60%. In other words, the residual shear strength of a joist with a large opening may be as low as 40%.

3.4 The Shear Strength of Joists with Reinforced Web Opening

Similarly to flexural tests, three types of reinforcement schemes namely, Scheme-A, Scheme-B and Scheme-C, were considered for shear tests. These reinforcements were used for both circular and square openings. The reinforced schemes –A and –B are based on the AISI (2004) requirements. The reinforcement details were given in page 2-6, thus, they are not repeated herein.

Reinforcement Scheme - C (Proposed)

The shear reinforcement scheme-C is different from the flexural reinforcement scheme-C, and it involves screw fastening (No. 8 self-drilling screws) of bridging channels [depth 38mm (1-1/2”), thickness 54 mils] along all four edges of the opening. Note that the bridging channels are 54mils thick whereas the main joist section is of 43mil (1.092 mm) thick. The shear reinforcements consisted of horizontal and vertical reinforcements. Horizontal reinforcements consisted of two bridging channels of length determined by width of the opening plus one half of the depth of the opening on both sides and a minimum edge distance for screws (10mm). Therefore, the total length of the horizontal reinforcements was 274 mm (10.7”). Vertical reinforcements included two bridging channels of length equal to the depth of the web of receiving channel 203mm (8 inch). One horizontal reinforcement was fastened along the top edge of the opening, and the other one was placed along the bottom edge of the opening. The channels were screw fastened at a spacing of 31.75 mm (1.25”) ($d/4$, where d is depth of the openings) close to the opening edges within the opening region, starting from the central screw.



Vertical reinforcements were placed closer to the vertical edges of the openings. Four screws were fastened at the corner of horizontal and vertical reinforcements to create a joint. This system produces a Virendeel type reinforcement system. This reinforcement system, as shown in Figure 3.3, was developed based on several trial reinforcement schemes involving different channel types and screw patterns.



Figure 3.3 Virendeel Reinforcement Scheme



Single tests were carried out for each of the reinforce schemes “A” and “B” for circular web openings, however, three identical tests were conducted for remaining cases. The detailed shear test results including the load-displacement relations and the photographs of the failures are given in Appendix C, thus, not repeated herein. However, the Tables 3.2 and 3.3 summarize the shear capacities of the cold-formed steel sections with reinforced web opening.

Table 3.2 Shear strength of CFS joists with reinforced circular web opening in high shear region (Shear Zone)

Test Designation	Peak Shear at Opening Region (kN)	Percentage Reduction in Shear Capacity	Sample Pictures	Failure Mode
S-CR_A Plate Reinforcement (Scheme-"A")	Test 1: 11.52 Test 2: 11.12 Test 3: 11.06 Average: 11.52 Standard Deviation: 0.25	-7.32 %		Shear diagonal failure at the opening
S-CR_B Stud Reinforcement (Scheme-"B")	Test 1: 12.46 Test 2: 12.05 Test 3: 11.98 Average: 12.46 Standard Deviation: 0.11	+0.24 %		Shear diagonal failure at opening + shear-flexural failure out of the opening
S-CR_C Bridging Channel Reinforcement (Scheme-"C")	Test 1: 12.77 Test 2: 12.86 Test 3: 13.22 Average: 12.95 Standard Deviation: 0.24	+4.18 %		Shear + flexural failure out of the opening

1 kN = 0.225 kip

Table 3.3 Shear strength of CFS joists with reinforced square web opening in high shear region (Shear Zone)

Test Designation	Peak Shear at Opening Region (kN)	Percentage Reduction in Shear Capacity	Sample Pictures	Failure Mode
S-SR_A Plate Reinforcement (Scheme-"A")	Test 1: 8.40 Test 2: 8.22 Test 3: 7.63 Average: 8.08 Standard Deviation: 0.40	-35.00 %		Shear diagonal failure at opening
S-SR_B Stud Reinforcement (Scheme-"B")	Test 1: 9.25 Test 2: 8.11 Test 3: 8.18 Average: 8.52 Standard Deviation: 0.64	-31.57 %		Shear diagonal failure at opening
S-SR_C Bridging Channel Reinforcement (Scheme-"C")	Test 1: 12.44 Test 2: 12.61 Test 3: 12.47 Average: 12.50 Standard Deviation: 0.09	+0.56 %		Shear + flexural failure out of opening

1 kN = 0.225 kip

Twelve tests were carried out following the AISI (2004) reinforcement (hole-patching) requirements. Plate and stud reinforcements (schemes “A” and “B”) for both circular and square holes were considered for these shear tests. As shown in Tables 3.2 and 3.3, three identical tests were considered for all these cases. Detail results corresponding to these tests are given in Appendix –C. Most of the specimens containing reinforcement scheme “A” continue to fail at the opening location. Similarly, the test specimens containing reinforcement scheme “B” also failed at the opening location. Specimens with square holes reinforced with schemes “A” and “B” failed at about 30% less shear compared to solid sections. Specimens with reinforced circular holes also failed at lesser loads. This indicates that the reinforcement schemes “A” and “B” are not adequate to restore the shear strengths of joist sections with opening.

Table 3.2 and 4.3 also give the shear resistances of scheme “C” reinforced sections having circular and square opening. It is clearly evident that the specimens with reinforcement scheme “C” failed at locations outside the reinforced opening location. In these specimens the failure was on the span with no openings, and the failure pattern was similar to the one observed in the solid joist sections. Thus, it can be stated that the reinforcement scheme “C” is capable of restoring the original shear strength of a cold-formed steel joist section.

Key Observation: 5

The reinforcement schemes “A”, and “B”, established as per AISI (2004) patching requirements, are not adequate to restore the shear strengths of joist sections with opening.

Key Observation: 6

The reinforcement scheme “C”, Virendeel type reinforcement system, for web opening is capable of restoring the original shear strength of a cold-formed steel joist section.

4.0 REINFORCEMENT SCHEMES FOR JOIST HAVING WEB OPENINGS

4.1 Overview

Previous chapters presented the experimental flexural strengths and the shear strengths of cold formed steel joists [43mils (1.092 mm) thick, 8” (203.2 mm) deep joist lips channel sections] having a large web opening. These chapters established the impact of such web openings, and they also determined the reinforcement schemes those restored the original strengths [Strengths of joists with no openings]. In the previous chapters, the flexural effects and the shear effects were studied separately, and the flexural zones and the shear zones were not defined. The flexural zone and shear zone for a joist member depend on the structural arrangement and the loadings. This chapter establishes definitions for the flexural zone and shear zone for cold-formed steel joists and prescribes appropriate reinforcement schemes for the corresponding zones.

The definitions for the flexural zone and the shear zone were established based on the key findings of the previous chapters;

Key Observation: 1

The reduction in the flexural strength of a cold formed steel joist section due to a large web opening (up to 65% of web height) is less than 15%.

Key Observation: 4

The reduction in the shear strength of a cold-formed steel joist section, in the presence of high moments and due to the presence of a large web opening (up to 65% of web height), may be as high as 60%. In other words, the residual shear strength of a joist with a large opening may be as low as 40%.

The reinforcement schemes prescribed herein for the corresponding zones were decided based on the key findings of the previous chapters;

Key Observation: 2

The reinforcement schemes “A”, “B”, and “C” considered in this study can restore the flexural strength of cold formed steel joist sections having a large web opening.

Key Observations: 5 & 6

The reinforcement schemes “A”, and “B”, established as per AISI (2004) patching requirements, are not adequate to restore the shear strengths of joist sections with opening. The reinforcement scheme “C”, Virendeel type reinforcement system, for web opening is capable of restoring the original shear strength of a cold-formed steel joist section.

4.2 Definition of the “Flexural Zone” and the “Shear Zone”

In the analysis and design of cold-formed steel joists for house construction, it is reasonable to;

- assume that the floor joist is subjected to uniformly distributed loads
- assume that the design of a floor joist is governed by the largest moment and that the moment resistance is equal to or more than the largest moment caused by the loads
- assume that the whole joist has a uniform cross-section, thus its moment resistance is constant for the whole length of the joist
- assume that a design of a floor joist based on moment resistance results in a joist possessing a shear resistance equals to the corresponding largest shear in the joist ($V_{\text{resistance}} = V_{\text{loads}}$)

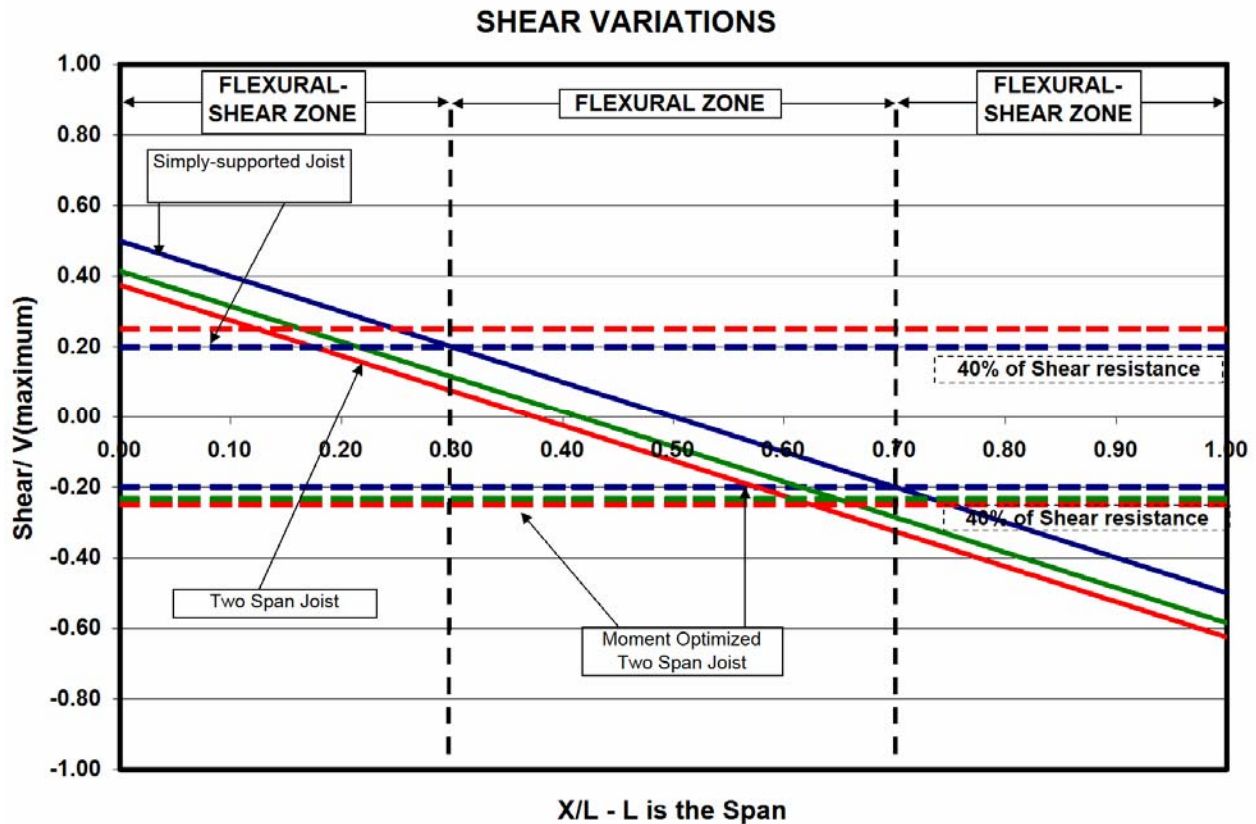

Figure 4.1 Shear Variations on Floor Joist

Figure 4.1 shows the non-dimensional shear variation in a floor joist having different structural arrangements (simple support, continuous support, etc.);

- If the joist is simply supported, then the maximum shear ($V_{\text{max}} = 0.50wL = V_{\text{design}}$) occurs at the supports. Shears greater than $0.4V_{\text{design}}$ exist outside $0.30L$ and $0.70L$, where L is the span length. The shears within the region $0.3L$ and $0.7L$ (mid-span region) for this structural arrangement will be less than $0.4V_{\text{design}}$

- If the joist is continuous over two or more spans (shown as two span joist), then the maximum shear ($V_{\max} = 0.625wL = V_{\text{design}}$) occurs over the support. Shears greater than $0.4V_{\text{design}}$ exist outside $0.125L$ and $0.625L$, where L is the span length. Choosing $0.30L$ and $0.70L$ region (mid-span region) the shear within this region for this structural arrangement will be less than $0.49V_{\text{design}}$
- If the joist has an over-hang and the joist had been designed such that the moment over the support is equal to moment at the mid-span (moment optimized two-span joist), then the maximum shear ($V_{\max} = 0.585wL = V_{\text{design}}$) occurs over the support. Shears greater than $0.4V_{\text{design}}$ exist outside $0.18L$ and $0.65L$, where L is the span length. Considering the region between $0.30L$ and $0.70L$ (mid-span region) the shear within this region for this structural arrangement will be less than $0.52V_{\text{design}}$
- Considering the three possible structural arrangements, and choosing $0.25L$ and $0.75L$ region (mid 50% region) the shear within this region will be less than $0.60V_{\text{design}}$
- Considering the three possible structural arrangements, and choosing $0.30L$ and $0.70L$ region (mid 40% region) the shear within this region will be less than $0.52V_{\text{design}}$
- Choosing $0.35L$ and $0.65L$ region (mid 30% region) and considering the three possible joist structural arrangements, the shear within this region will be less than $0.44V_{\text{design}}$

Key Observation: 7

Noting that, in general, the shear resistance ($V_{\text{resistance}}$) of a CFS joist designed based on governing moments is greater than the peak shear force due to corresponding uniformly distributed loads, and assuming that the reduction in the shear strength of a CFS joist section due to a large web opening (up to 65% of web height) would be less than 50%, it is observed that for all possible structural arrangements, the shear force within the mid 40% region of a joist ($0.30L$ and $0.70L$) will be less than 50% of the shear resistance of the joist. Thus the openings in the mid 40% region of a joist will not need the shear reinforcements, however, such openings will need the flexural reinforcements.

Key Observation: 8

Since the shear forces outside the mid 40% region of a joist ($0.30L$ and $0.70L$) may be more than 50% of the shear resistance of the joist, and may be subjected to high moments, openings located in regions outside the mid 40% of the joist will need the shear reinforcements.

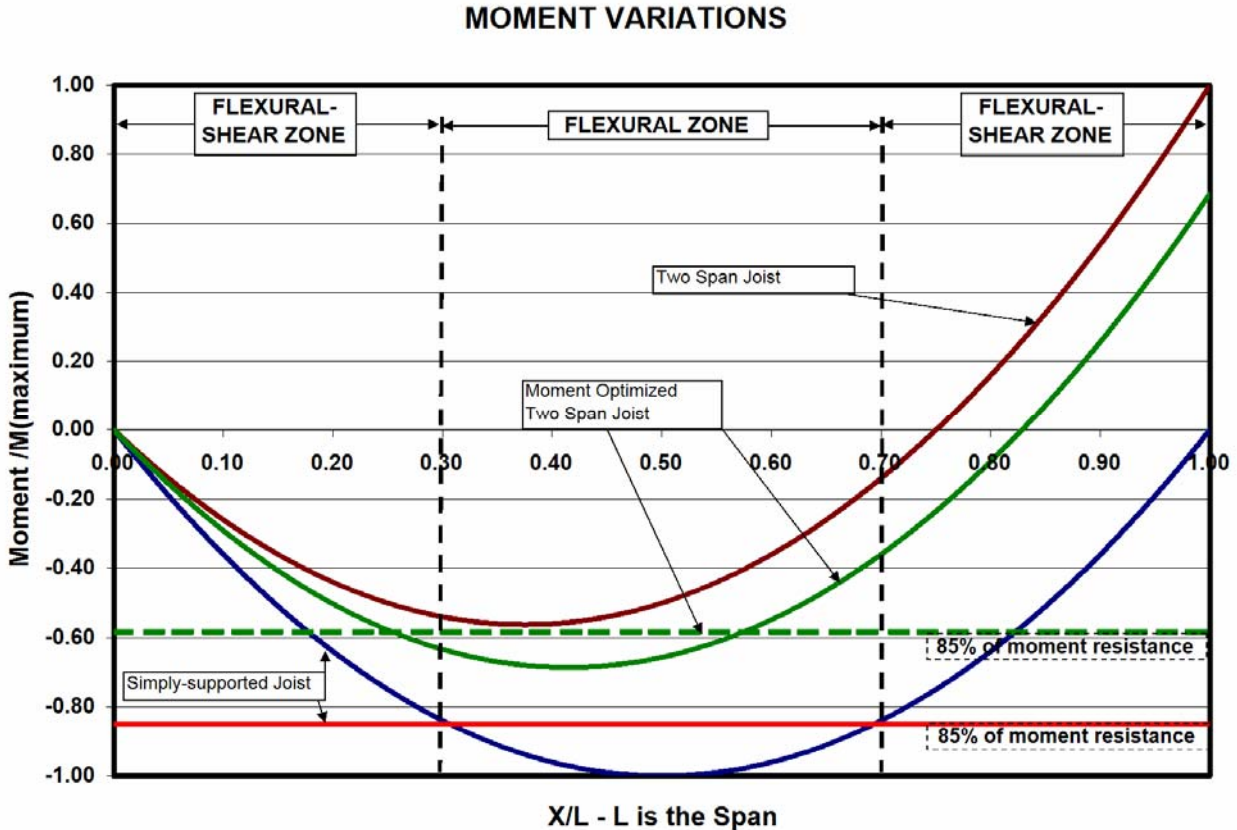

Figure 4.2 Moment Variation on Floor Joist

Figure 4.2 shows the non-dimensional moment variations in a floor joist subjected to uniformly distributed loads;

- If the joist is simply supported, then the maximum moment ($M_{\max} = wL^2/8 = M_{\text{design}}$) occurs in the mid-span. Focusing on the mid-span region, moments greater than $0.85M_{\text{design}}$ exist between $0.305L$ and $0.695L$, where L is the span length.
- If the joist is continuous over two or more spans, then the maximum moment ($M_{\max} = wL^2/8 = M_{\text{design}}$) occurs over the support. Focusing on the mid-span region, no location experiences moments greater than $0.85 M_{\text{design}}$
- If the joist has an over-hang and the joist had been designed such that the moment over the support is equal to moment at the mid-span (moment optimized two-span joist), then the maximum moment ($M_{\max} = 0.686wL^2/8 = M_{\text{design}}$) occurs over the support and in the mid-span region at $0.41 L$. Focusing on the mid-span region, moments greater than $0.85M_{\text{design}}$ exist between $0.255L$ and $0.575L$, where L is the span length.
- For all other structural span arrangement for the joist the maximum moment occurs either in the mid-span or at the support. Further more, it can be stated that regardless of the joist

structural arrangement, focusing on the mid-span, moment more than $0.85M_{\text{design}}$ may exist between $0.255L$ and $0.695L$, where L is the span length.

- Considering all possible structural arrangements, and choosing $0.25L$ and $0.75L$ region (mid 50% region) the sagging moments within this region may be more than $0.84M_{\text{design}}$.
- Considering all possible structural arrangements, and choosing $0.30L$ and $0.70L$ region (mid 40% region) the sagging moments within this region may be more than $0.92M_{\text{design}}$. For simply supported joists the moments within this region may be more than $0.84M_{\text{design}}$.
- Choosing $0.35L$ and $0.65L$ region (mid 30% region) and considering all possible joist structural arrangements, the sagging moments within this region may be more than $0.98M_{\text{design}}$. For simply supported joists the moments within this region may be more than $0.91M_{\text{design}}$.

Key Observation: 9

Since the shear forces within the mid 40% region of a joist ($0.30L$ and $0.70L$) is less than 50% of the shear resistance of the joist no shear reinforcements are needed. However, since the moments within the mid 40% region of a joist ($0.30L$ and $0.70L$) is more than 85% of the moment resistance of the joist, openings located in regions within the mid 40% of the joist will need the flexural reinforcements.

Conclusion: 1

The mid 40% region of a joist ($0.30L$ and $0.70L$) can be defined as “Flexural Zone”, and will need flexural reinforcements for openings in this region. The regions outside the mid 40% region of a joist ($0.30L$ and $0.70L$) can be defined as “Shear Zone”, and openings located in regions outside the mid 40% of the joist will need the shear reinforcements.

4.3 Reinforcement Schemes for Flexural Zones (Mid 40% of the joist)

Based on the results presented in chapter 2, the following key observation was made.

Key Observation: 2

The reinforcement schemes “A”, “B”, and “C” considered in this study can restore the flexural strength of cold formed steel joist sections having a large web opening.

Thus, the following reinforcement details are proposed for the flexural zone.

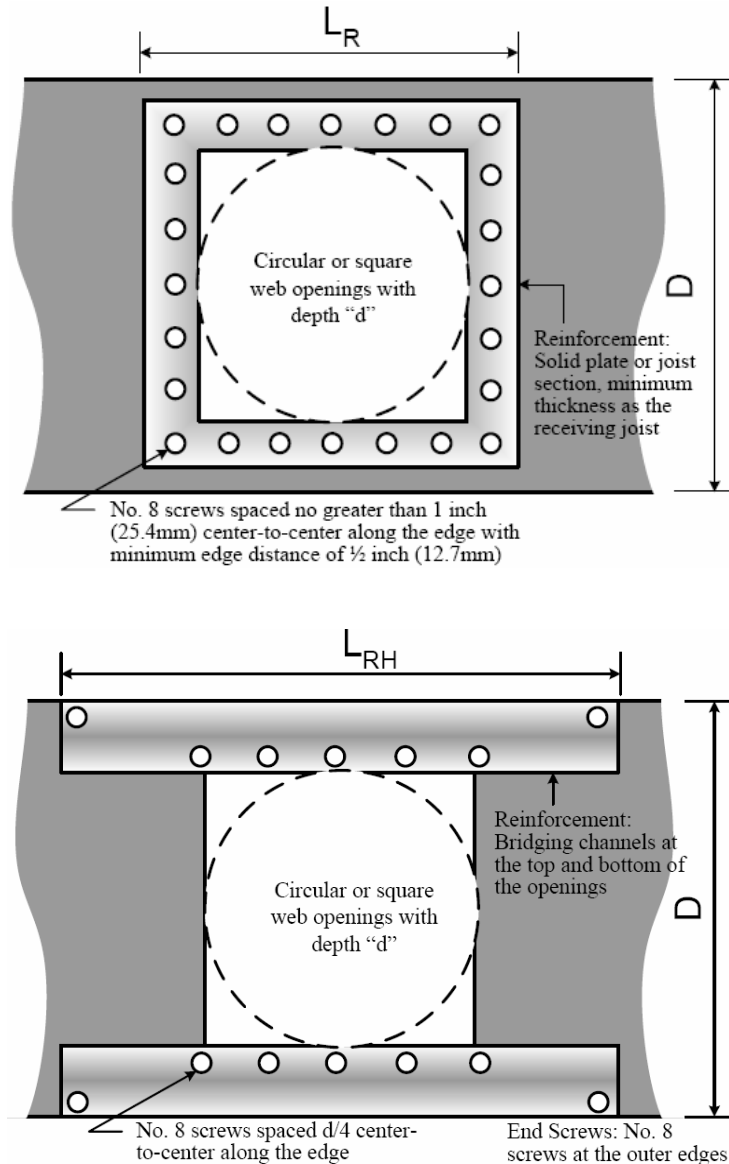

Figure 4.3 Reinforcement Schemes for Flexural Zone

4.4 Reinforcement Schemes for Shear Zones (Outside the Mid 40% of the joist)

Based on the results presented in chapter 3, the following key observations were made.

Key Observations: 5 & 6

The reinforcement schemes “A”, and “B”, established as per AISI (2004) patching requirements, are not adequate to restore the shear strengths of joist sections with opening. The reinforcement scheme “C”, Virendeel type reinforcement system, for web opening is capable of restoring the original shear strength of a cold-formed steel joist section.

Thus, the following reinforcement details are proposed for the shear zone.

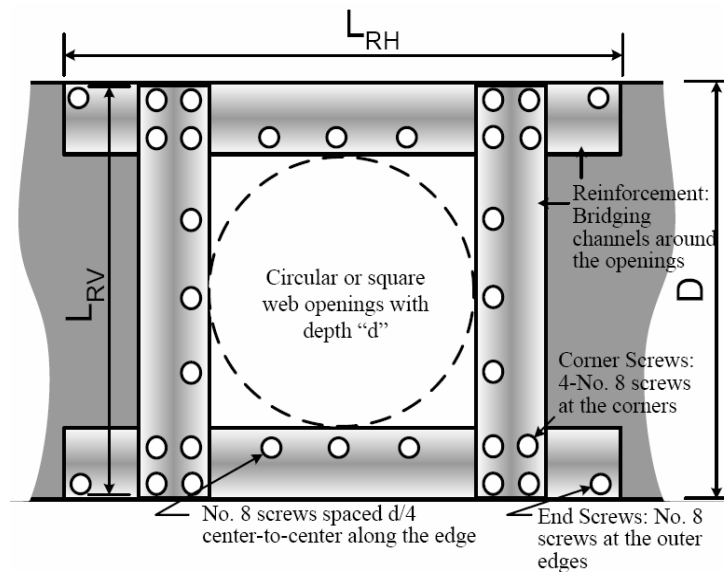

Figure 4.4 Reinforcement Schemes for Shear Zone

5.0 REFERENCES

Abdel-Rahman, N. and Sivakumaran, K. S., (1998), "Effective Design Width for Perforated Cold-Formed Steel Compression Members", *Canadian Journal of Civil Engineering*, 25, 319-330.

AISI (2001) North American Specification for the Design of Cold-Formed Steel Structural Members, American Iron and Steel Institute, Washington, DC.

AISI (2004), Supplement to the Standard for Cold-Formed Steel Framing – Prescriptive Method for One and Two Family Dwellings, 2001 Edition, American Iron and Steel Institute, Washington, DC.

ASTM (2003), "Standard Test Methods and Definitions for Mechanical Testing of Steel Products", A 370-03a, American Society of Testing and Materials, Philadelphia, USA.

Bower, J. E. (1966). "Experimental Stresses in Wide-Flange Beams with Holes." *Journal of Structural Division*, 92 (ST2, Oct), 167-185.

Bower, J. E. (1968). "Ultimate Strength of Beams with Rectangular Holes." *Journal of Structural Division*, 94 (ST6, June), 1315-1337.

Congdon, J. D. and Redwood, R. G. (1970). "Plastic Behavior of Beams with Reinforced Holes." *Journal of Structural Division*, 93 (ST9, Sept.), 1933-1957.

Copper, P. B. and Snell, R. R. (1972). "Tests on Beams with Reinforced Web Openings." *Journal of Structural Division*, 98 (ST3, Mar), 611-632.

Davies J. M., Leach, P., Taylor, A., (1997). "The Design of Perforated Cold-Formed Steel Sections Subjected to Axial Load and Bending." *Thin-walled structures*. 40, 239-262.

Hoglund, T., (1971). "Strength of Thin Plate Girders with Circular and Rectangular Web Holes without Web Stiffeners." *Proceedings of the Colloquium of the International Association of Bridge and Structural Engineering*, London.

LaBoube, R. A., Yu, W. W., Langan, J. E. and Shan, M. Y. (1997). "Cold-Formed Steel Webs with Openings: Summary Report." *Thin-walled structures* 27 (1), 79-84.

Narayanan, R., Al-Amery, R. I. M., and Roberts, T. M. (1989). "Shear Strength of Composite Plate Girders with Rectangular Web Cut-Outs." *Journal of Construction Steel Research*, 12, 151-166.

Narayanan, R. and Der-Avanessian, N. G., (1985). "Design of Slender Webs Having Rectangular Holes." *Journal of Structural Engineering*, 111(4), 777-787.

Narayanan, R. and Der-Avanessian, N. G., (1984). "Elastic Buckling of Perforated Plates under Shear." *Thin-Walled Structures*, 2, 51-73.

Pennock, R. W. (2001). "Strength of Light gauge Cold Formed Steel Joists with Web Perforation." Senior report, University of New Brunswick, New Brunswick Canada.

Pu, Y., Godley, M. H. R., Beale, R. G., Lau, H. H., (1999). "Prediction of Ultimate Capacity of Perforated Lipped Channels." *Journal of Structural Engineering*, 125 (5), 510-514.

Redwood, R. G. (1971). "Simplified Plastic Analysis for Reinforced Web Holes." *Engineering Journal*, AISC, Vol. 8, No. 4.

Redwood, R.G., and Shrivastava, S.C., (1980), *Design Recommendations for Steel Beams with Web Holes*, *Canadian Journal Civil Engineering*, Vol.7, pp.642-650.

Redwood, R. G. and Uenoya, M. (1979). "Critical Loads for Webs with Holes." *Journal of Structural Division*, 105 (ST10, Oct), 2053-2067.

Roberts, T. M. and Azizian, Z. G. (1984). "Strength of Perforated Plates Subjected to In-Plane Loading." *Thin-Walled Structures*, 2, 153-164.

Segner, E. P. (1964). "Reinforcement requirements for Girder Web Openings." *Journal of Structural Division*, 90 (ST3, June), 147-164.

Shan, M. Y., LaBoube, R. A., Yu, W. W., (1994). "Bending and Shear Behavior of Web Elements with Openings." *Journal of Structural Engineering*, 122 (8), 854-859.

Shanmugam, N.E, (1997). "Openings in Thin-Walled Steel structures." *Thin-walled structures* 28 (3/4), 355-372.

Shanmugam, N.E. and Thevendran, V. (1992). "Critical Loads of Thin-Walled Beams Containing Web Openings." *Thin-walled structures* 14, 219-305.

Schuster, R. M., Rogers, C. A., and Celli, A. (1995). "Perforated C-Section in Shear.", *Research into Cold Formed Steel*, Progress Report No. 1 of Phase 1 of CSSBI/IRAP Project, University of Waterloo, Waterloo, ON.

Sivakumaran, K. S., and Zielonka, K. M. (1989). "Web Crippling Strength of Thin-Walled Steel Members with Web Openings." *Thin-walled structures* 8 (3/4), 295-319.

Sivakumaran, K.S., Ming Yin Ng, and Steven R. Fox, (2006), "Flexural Strength of Cold-Formed Steel Joists with Reinforced Web Openings", *Canadian Journal of Civil Engineering*, Vol.33, No.9, September 2006, pp. 1195 - 1208.

Yu, W. W. (2000), *Cold Formed Steel Design*, John Willey & Sons Inc., New York

Yu, W. W. and Davis, C. S. (1973). "Cold-Formed Steel Members with Perforated Elements." *Journal of Structural Division*, 99 (ST10, Oct), 2061-2077.

APPENDICES

REINFORCEMENT SCHEMES FOR COLD-FORMED STEEL JOISTS HAVING WEB OPENINGS

FINAL REPORT

TEST RESULTS

APPENDIX – A
COLD-FORMED STEEL JOISTS
SECTION DIMENSIONS AND MECHANICAL PROPERTIES

A.1 Overall Section Dimensions

Cold-formed steel (CFS) lipped channel joist sections are available in various depths and thicknesses. However, 8” (203.2 mm) deep lipped channel section is one of the most commonly used floor joist size. This investigation considered 43mils (1.092 mm) thick, 8” (203.2 mm) deep joist sections. The specified and measured dimensions of the sections used are given in Table A.1. The measured dimensions shown in the table are the average values based on the measured dimensions of all the joist sections used in this investigation.

A.2 Mechanical Properties

The mechanical properties of the steel joist sections were established in accordance with the tension testing procedures conforming to ASTM Standard Test A370 (ASTM, 2003). The mechanical properties of the 54mil and 43mil bridging channels that were used as reinforcements were also established.

Tensile test specimens

The mechanical properties of the flat zones of the cold-formed steel sections (i.e. flange and web) were established. Conforming to ASTM Standard Test A370 (ASTM, 2003), three tensile coupons were taken from the flat portions of three randomly selected CFS sections. For each such section, two coupons were taken from the web and one coupon was taken from one of the flanges, resulting in a total of nine tensile coupons. The locations of these tensile coupons with respect to the channel section are shown in Figure A.1. Two tensile coupons were also taken from flat portion of web of the 54mil and 43mil bridging channels. Therefore, a total of thirteen (13) tension test specimens were considered, and these specimens are identified in Table A.2. The first letter followed by a number, together, identifies the corresponding parent section. The third number and a letter, together, represents the tension test specimen number and the location of the coupon on the parent section. For example, “N-2-1c” identified as: “N-2”-parent section, “1c”- 1st test specimen cut from the compression flange. The coupons from bridging channels have been identified by their thickness and the specimen number. For example, “54-1” identified as: “54”- 54mils thickness and “1”- 1st test specimen. The tensile coupons were machined to dimension suggested by ASTM Standard Test A370 (ASTM, 2003) for sheet-type material. The specified

dimensions of the tensions test specimens are as shown in Figure A.1. Figure A.2 shows the photograph of all the test specimens, prior to testing. Actual width, coated thickness and the base metal thickness of each tension test specimens were measured. The base metal thickness was measured after removing the galvanized layer on the metal surface. The galvanized surface was removed by dipping one end of tensile coupons into the hydrochloric acid for a while. The measured widths and the base metal thickness are listed in Table A.2

The Test Procedure

An INSTRON5566 testing machine with a 10kN capacity calibrated load cell was used for these tests (see Figure A.3). The machine has a load accuracy of 0.5%. The coupons were mounted in the testing machine using the end grips and aligned with respect to the vertical axis of the machine. According to ASTM (2003), any loading rate can be applied up to half- of yield strength. A constant loading rate of 0.1 mm/min was applied up to half- of yield strength. The loading rate was then increased to 1-2 mm/min (ASTM suggestion for such coupons: 0.36-3.57 mm/min) until the yield point. The loading rate was further increased to 5 mm/min (ASTM suggestion for such coupons: 2.8-28.5 mm/min) until the ultimate strength leading to a fracture. Moreover, the rates of stressing from half- of yield strength through the yield strength were observed as 91-560 MPa/min (ASTM suggestion: 70-690 MPa/minute). The extensometer based extensions and the separation of test machine crossheads were monitored. A calibrated (12.5mm) INSTRON-2620-601 extensometer was attached to the center of the specimens to measure the axial elongations. This extensometer can measure a maximum of 20% strain, however, it was initially compressed to about 15% strain, thereby increasing the range of maximum strain to up to 35%.

The Test Results

The stress and the strength values for each test specimen were established based on the measured width at the reduced section, and the measured base metal thickness. The stress-strain relationships for these tension coupons are shown in Figures A.5 through A.9. Consistent stress-strain relationships were observed. The stress-strain curves showed yield plateau and strain hardening characteristics prior to rupture. A gradual yielding was also observed in some test coupons. The 0.01% offset, and 0.2% offset methods with an initial slope of 203,000 MPa were used to establish the proportional limit and the yield strength, respectively. Table A.3 shows the individual test results as well as the average mechanical properties based on nine tensile coupon test results. The proportional limit values ranged between 247 and 290 MPa, the yield strength values ranged between 304 and 317 MPa, whereas the ultimate strength values ranged between

393 and 406 MPa. The average proportionality limit, yield strength and ultimate strength were 280, 311 and 401 MPa with standard deviation 14, 5 and 5 MPa, respectively. Furthermore, as shown in Table A.3, the steel used in this investigation exhibited an average ultimate tensile strength to yield strength ratio of about 1.29 with standard deviation 0.01, and the average strain at rupture, which reflects the ductility of the steel, of 29% with standard deviation 2%. Table A.3 also shows the material properties of 54mils and 43mils bridging channels. The average yield strength and ultimate strength of 54mils bridging channels were 380 and 552 MPa, respectively. Similarly, the average proportionality limit, yield strength and ultimate strength of 43mils bridging channels were 221, 328 and 414 MPa, respectively.

Table A.1 Specified and Measured Sectional Properties and Mechanical Properties

Specified and Measured Sectional Properties and Mechanical Properties		
Properties	Specified	Measured
Web Height - D	203.2 mm	201.5 mm
Flange Width in Compression- B_c	41.1 mm	40.9 mm
Flange Width in Tension- B_t	41.1 mm	40.5 mm
Lip Depth in Compression- d_c	12.7 mm	11.9 mm
Lip Depth in Tension- d_t	12.7 mm	11.6 mm
Coated (Total) Thickness - t'	-	1.15 mm
Base Metal Thickness - t	1.09 mm (43 mils)	1.12 mm
Proportional Limit - F_p	-	280 MPa
Yield Strength - F_y	345 MPa	311 MPa
Ultimate Strength - F_u	420 MPa	401 MPa
Ultimate/Yield Strength - F_u/F_y	-	1.29
Strain at Rupture - ϵ_u	-	$\approx 29\%$

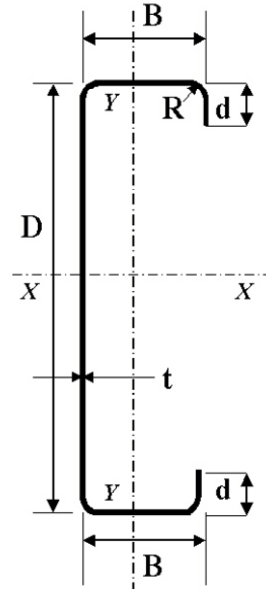

1 inch = 25.4mm, 50ksi=345MPa

Table A.2 Measured width and thickness for tension test specimens

Parent Section (ID)	Specimen ID	Coupon Width (mm)	Base Metal Thickness (mm)
Section 1 (F-N-2-R)	N-2-1c	13.00	1.12
	N-2-2w	12.99	1.12
	N-2-3w	12.99	1.13
Section 2 (F-C-2-R)	C-2-1t	12.85	1.13
	C-2-2w	12.85	1.12
	C-2-3w	12.87	1.13
Section 3 (F-S-3-L)	S-3-1c	12.92	1.10
	S-3-2w	12.88	1.10
	S-3-3w	12.94	1.09
	Average	12.92	1.12
	Standard Deviation	0.06	0.01
54 mils - Channel	54-1	12.78	1.37
	54-2	12.76	1.36
43 mils - Channel	43-1	12.78	1.10
	43-2	12.81	1.10

1 inch = 25.4mm

Table A.3 Measured material properties based on tension coupons tests

Specimen (ID)	Experimental Elastic Modulus (GPa)	Proportional Limit, F_p , (MPa)	Yield Strength F_y , (MPa)	Ultimate Strength F_u , (MPa)	F_u/F_y	Percent Elongation
N-2-1c	203	284	317	400	1.26	27
N-2-2w	208	290	311	406	1.31	28
N-2-3w	213	280	304	393	1.29	28
C-2-1t	201	274	317	407	1.28	29
C-2-2w	209	295	316	404	1.28	29
C-2-3w	212	288	309	402	1.30	25
S-3-1c	191	247	311	398	1.28	29
S-3-2w	213	287	307	397	1.29	32
S-3-3w	201	272	310	398	1.28	31
Average	206	280	311	401	1.29	29
Standard Deviation	7	14	5	5	0.01	2
54-1	200	272	381	550	1.44	N/A
54-2	168	N/A	379	554	1.46	N/A
43-1	167	N/A	329	413	1.26	N/A
43-2	196	221	327	415	1.27	N/A

Notes: Tension Coupon Identification Code

N-2-1c: “N-2”-Indicates the parent section, “1”- 1st tension test specimen, “c” or “t” or “w”- indicates the location of tension specimen c-compression flange, t-tension flange and w- web.

54-1: “54”- indicates the thickness in mils. (e.g. 54mils is 0.054inch), “1”- 1st tension coupon.

1 inch = 25.4mm, 50ksi=345MPa, 29,000ksi = 200GPa.

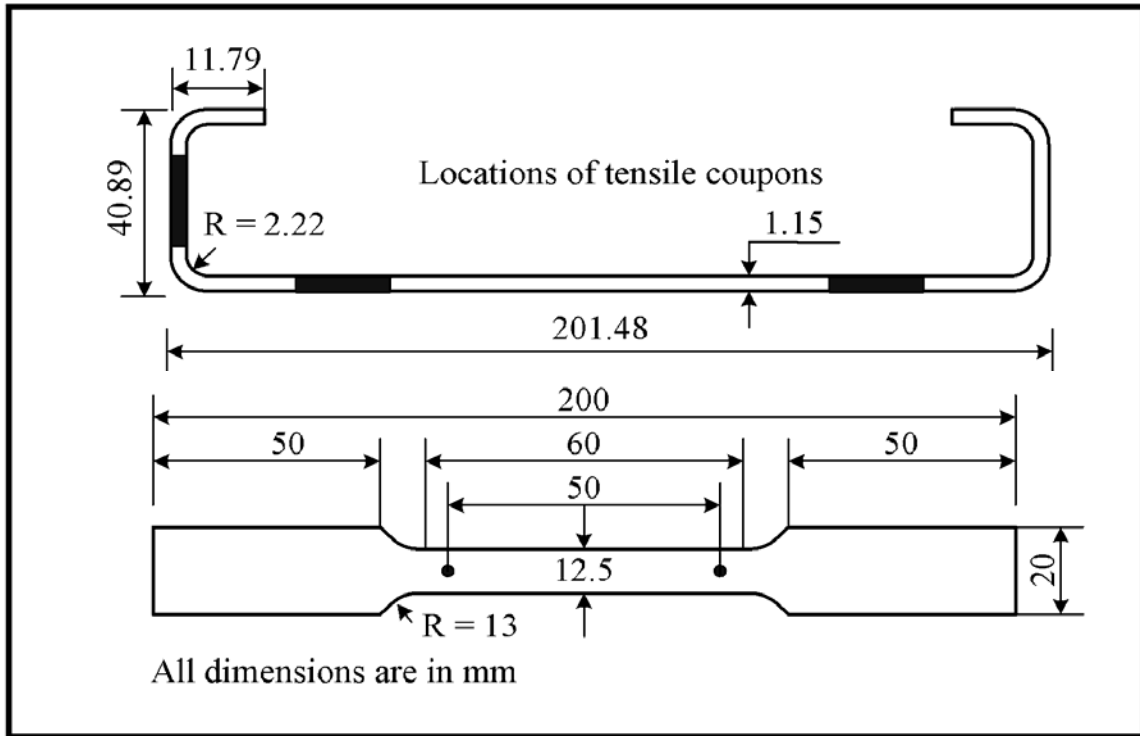

Figure A.1 Locations and specified dimensions of tension test specimens

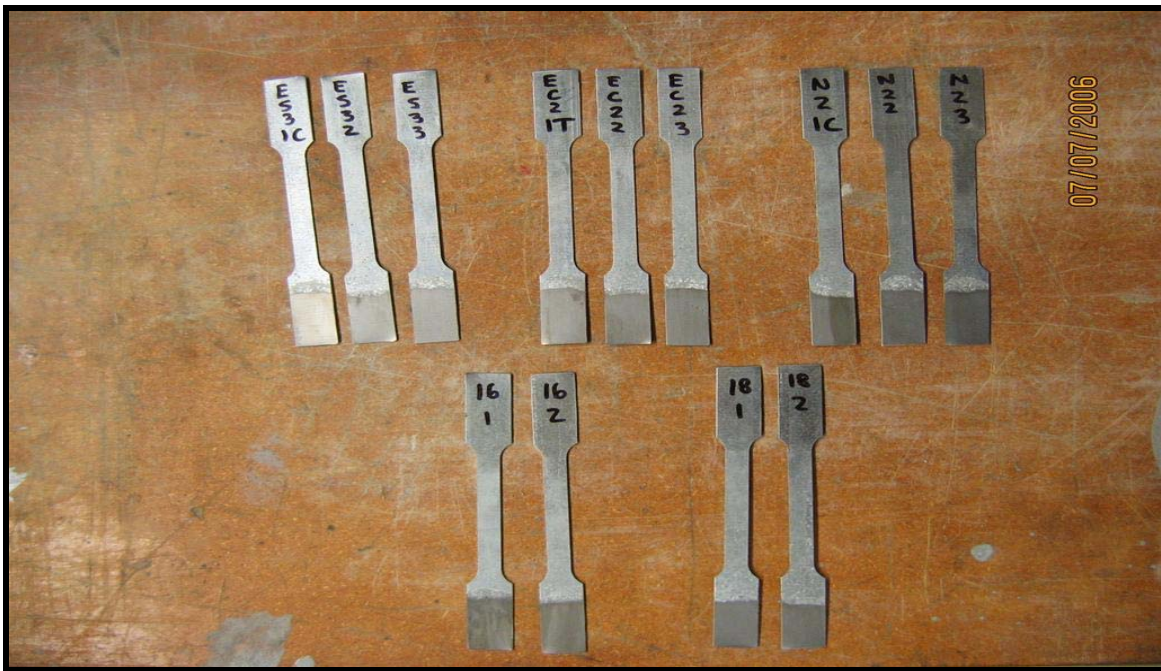

Figure A.2 Tension test specimens before testing

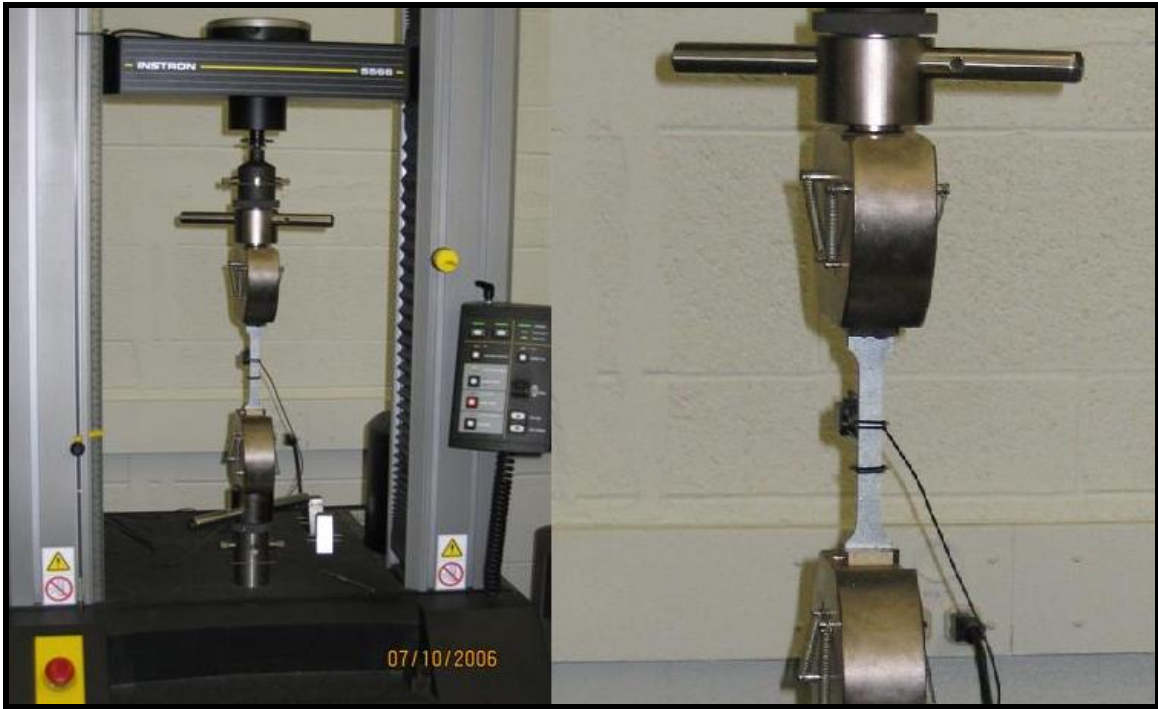
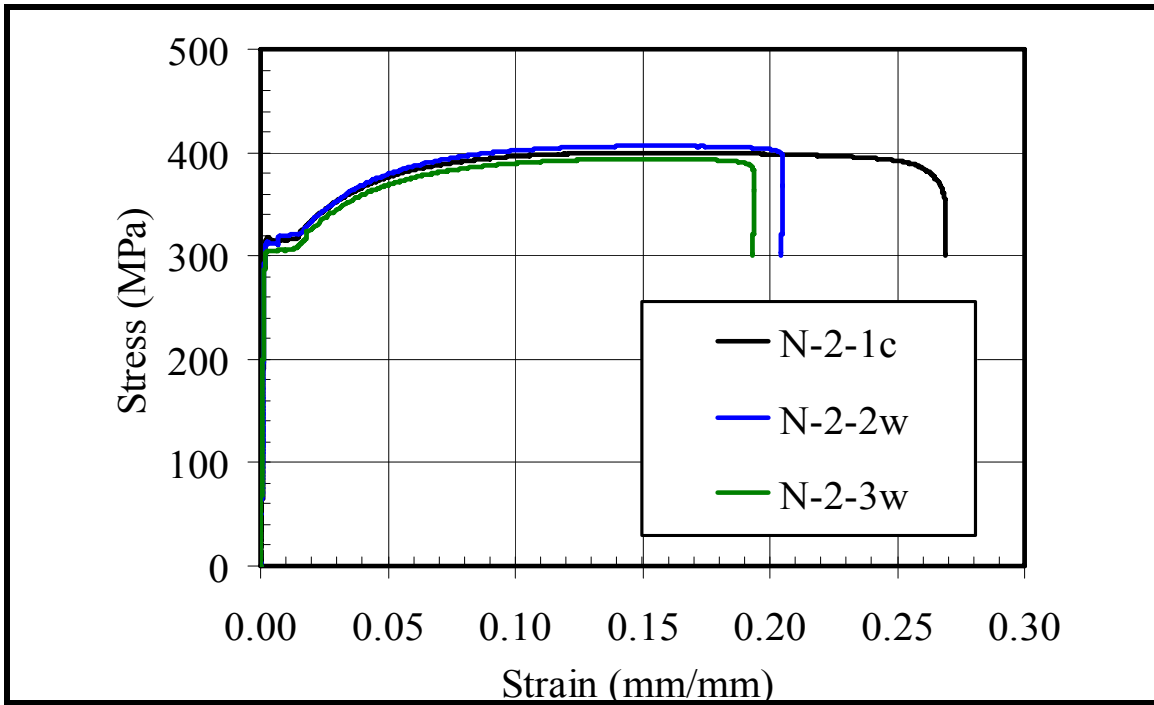

Figure A.3 Tension test specimens during testing using INSTRON-5566 machine



Figure A.4 Tension test specimens after testing



(a)

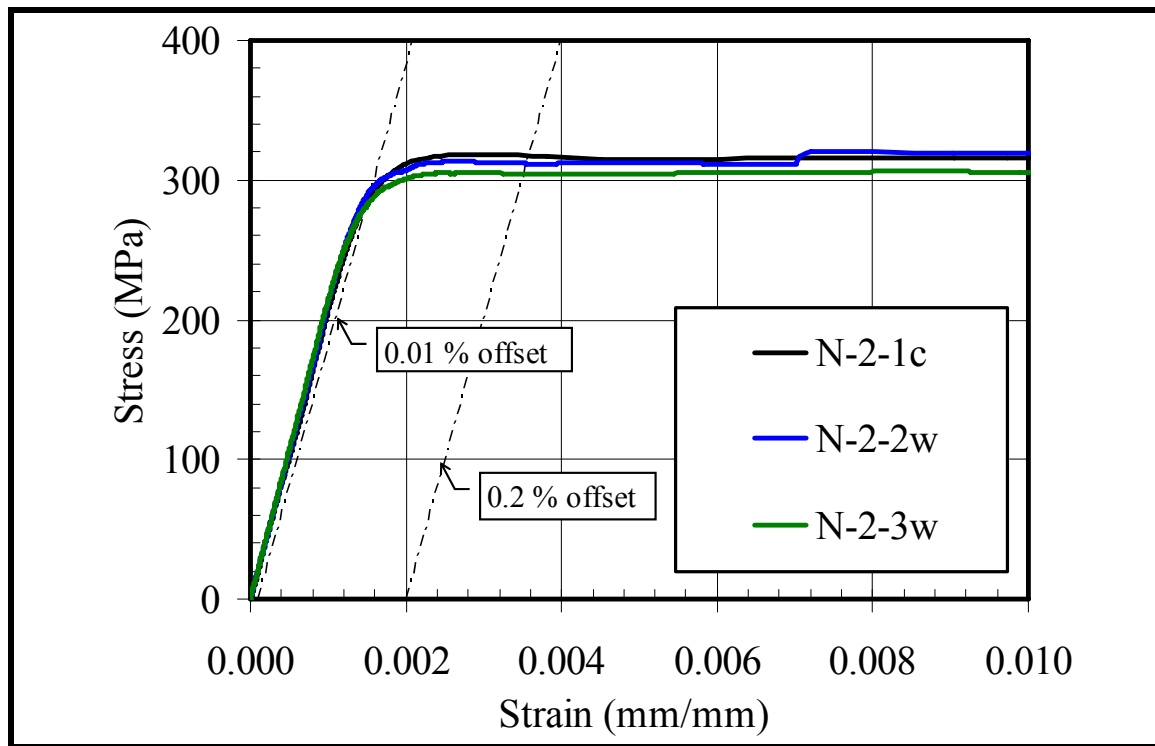

(b)

Figure A.5 Stress-strain relationships - Tension test specimens from section-1

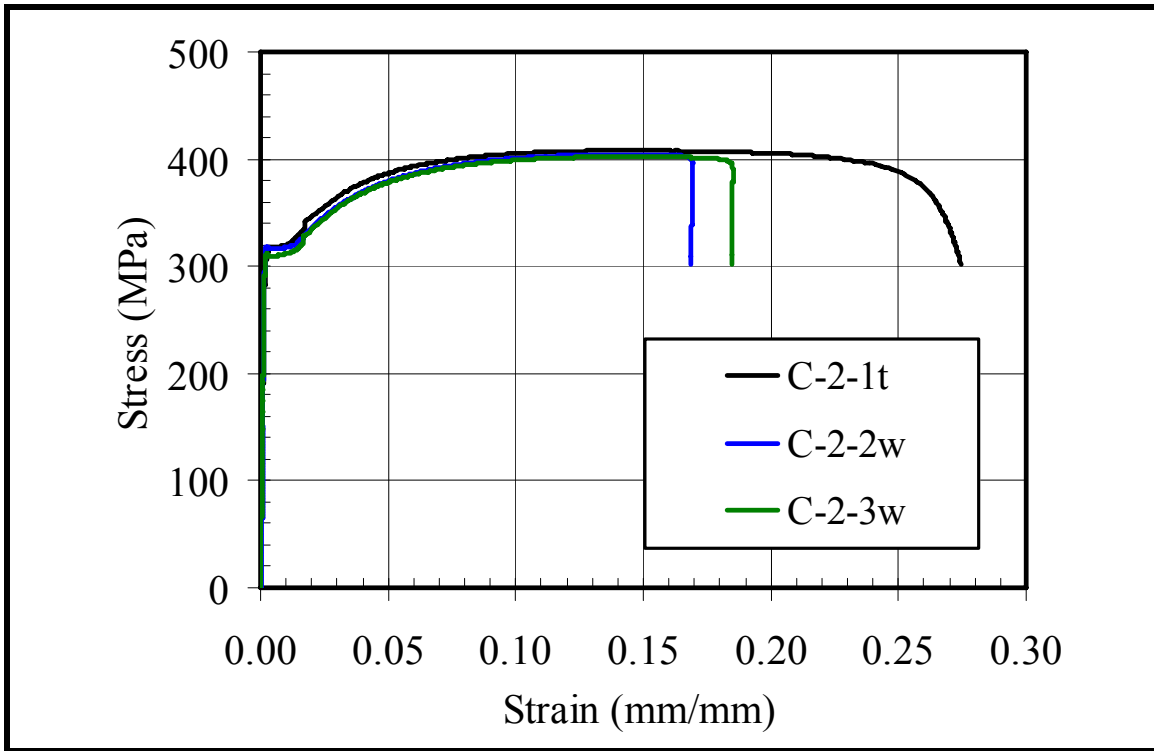

(a)

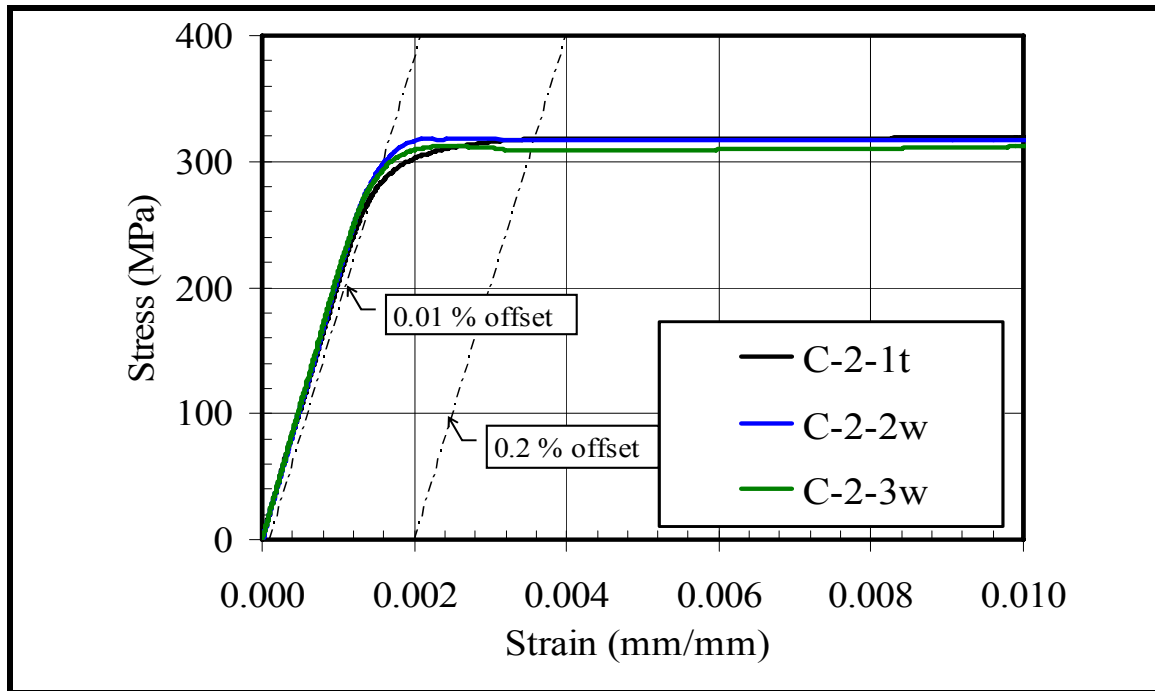

(b)

Figure A.6 Stress-strain relationships - Tension test specimens from section-2

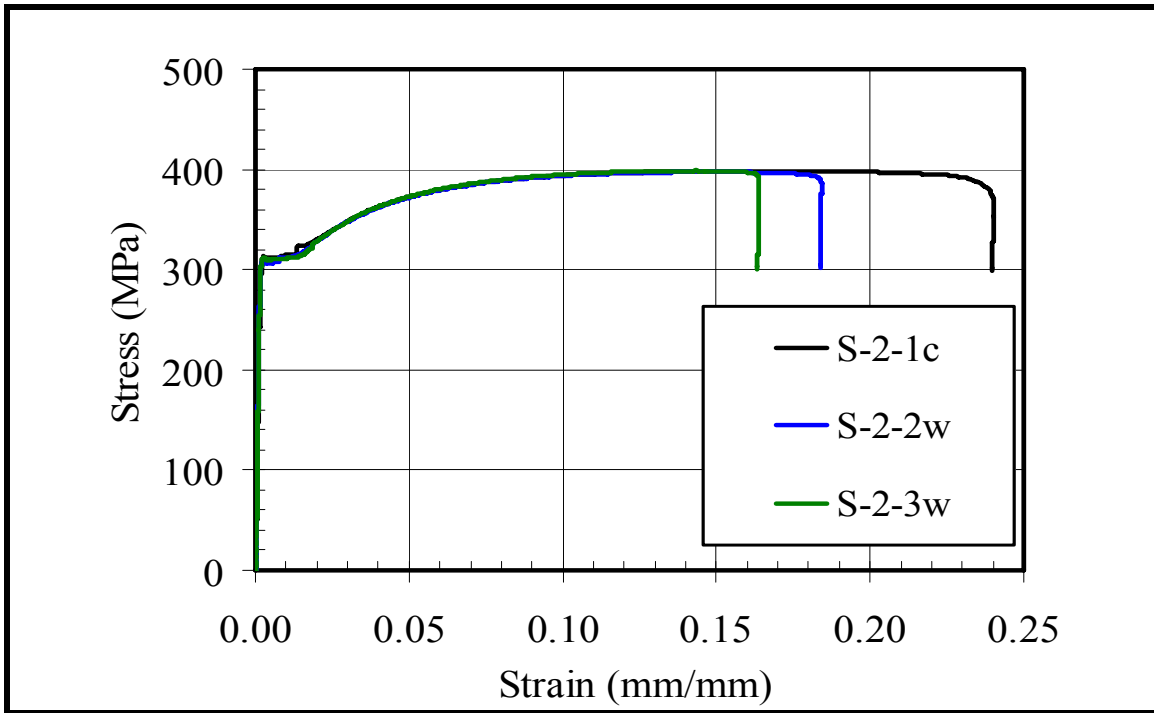

(a)

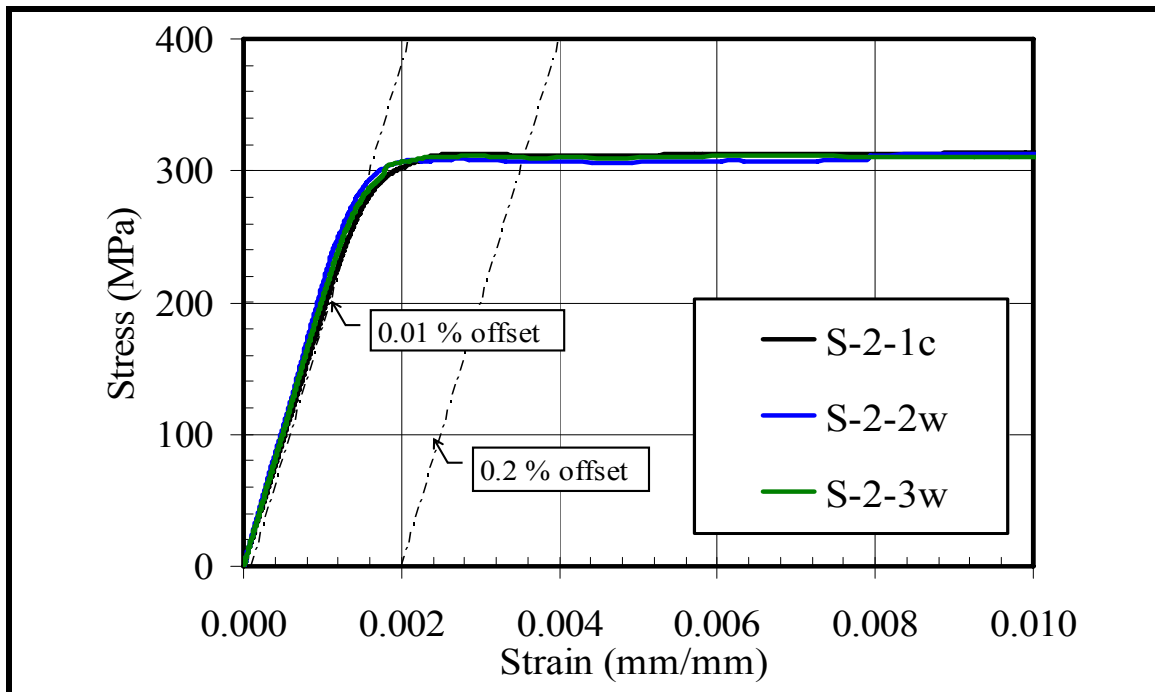

(b)

Figure A.7 Stress-strain relationships - Tension test specimens from section-3

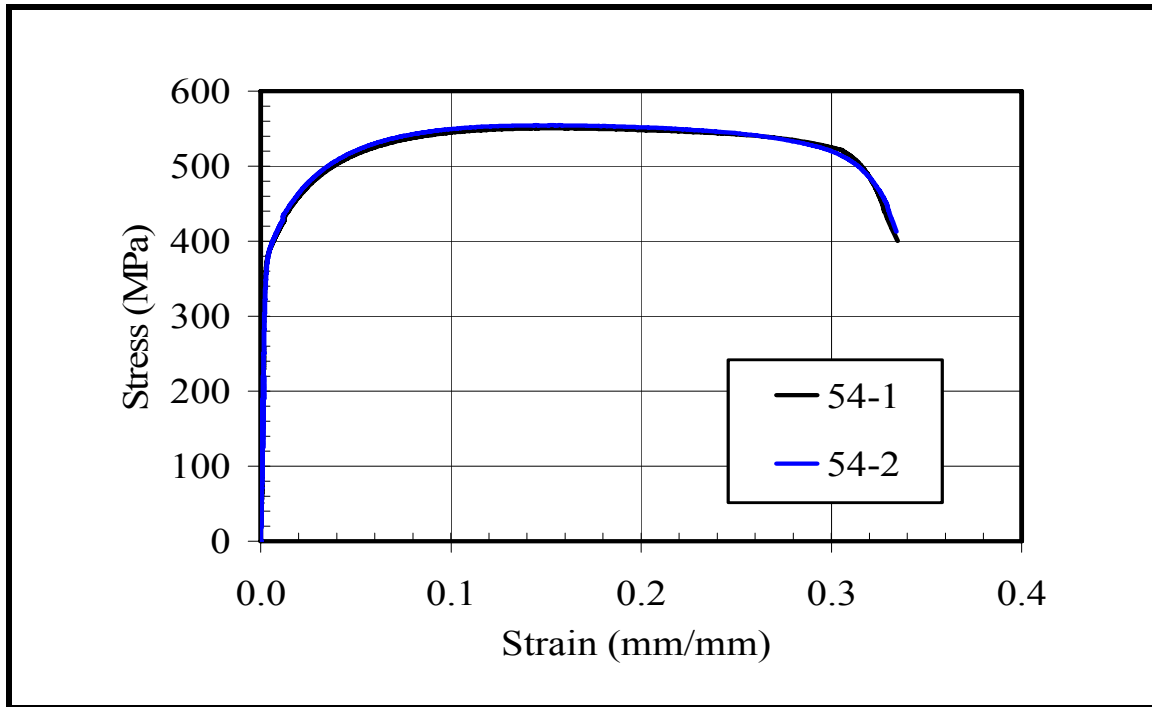

(a)

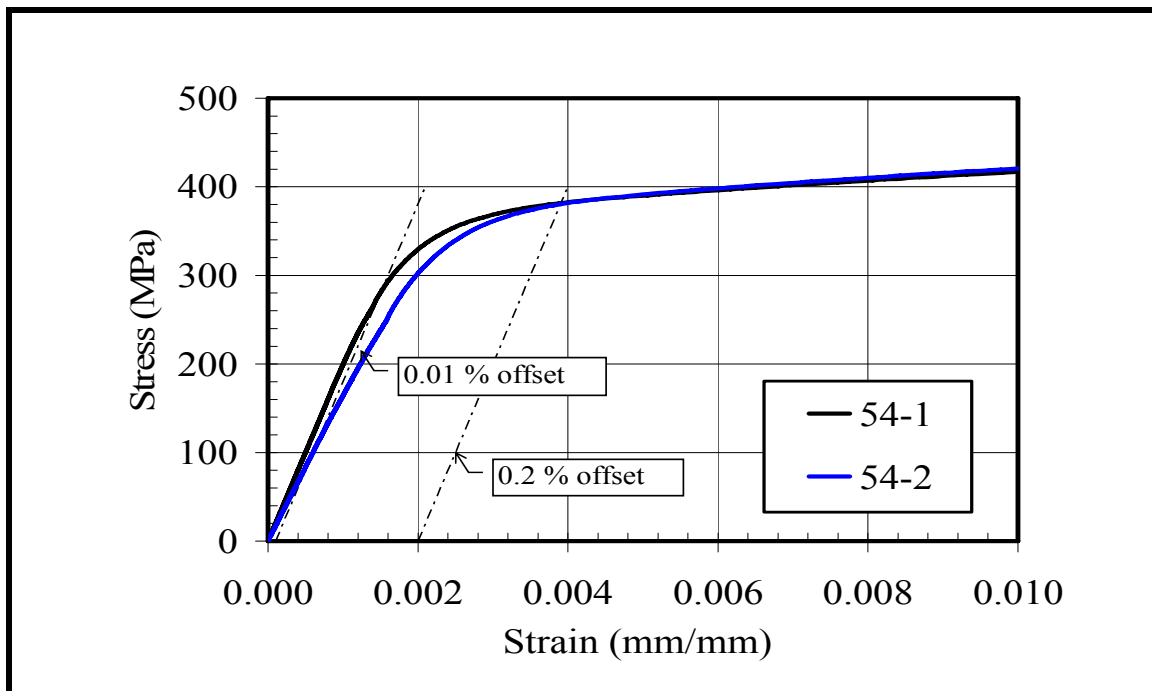

(b)

Figure A.8 Stress-strain relationships - Tension test specimens from 54mils - Channel

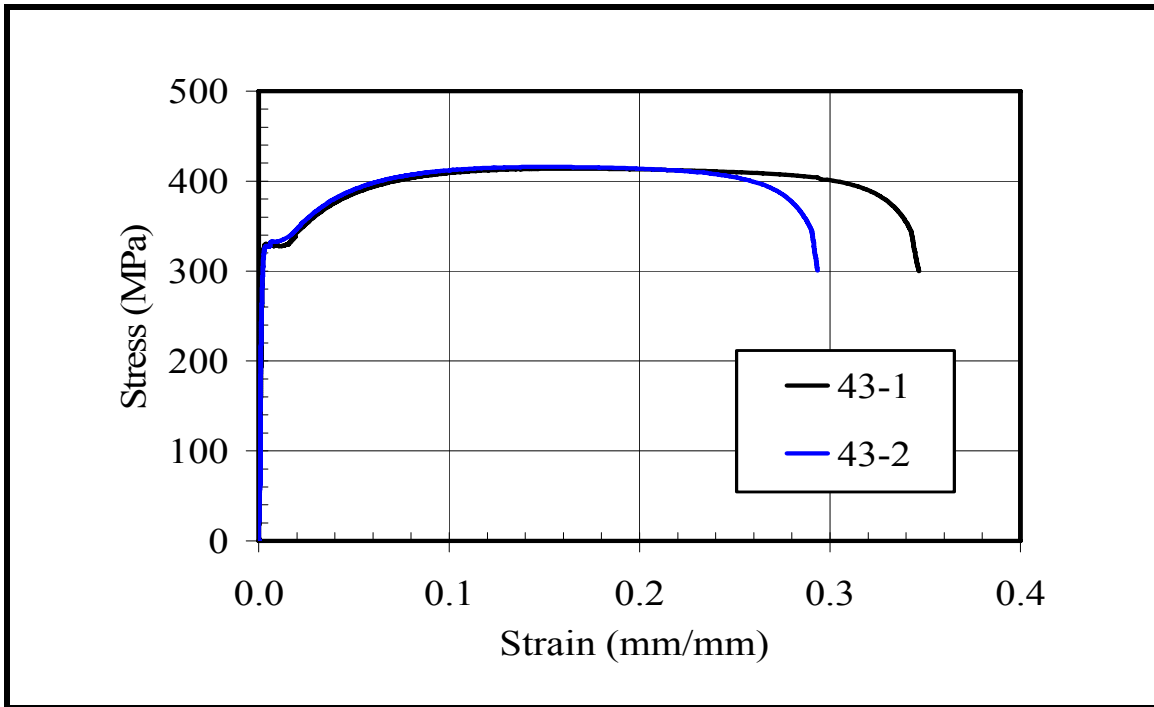

(a)

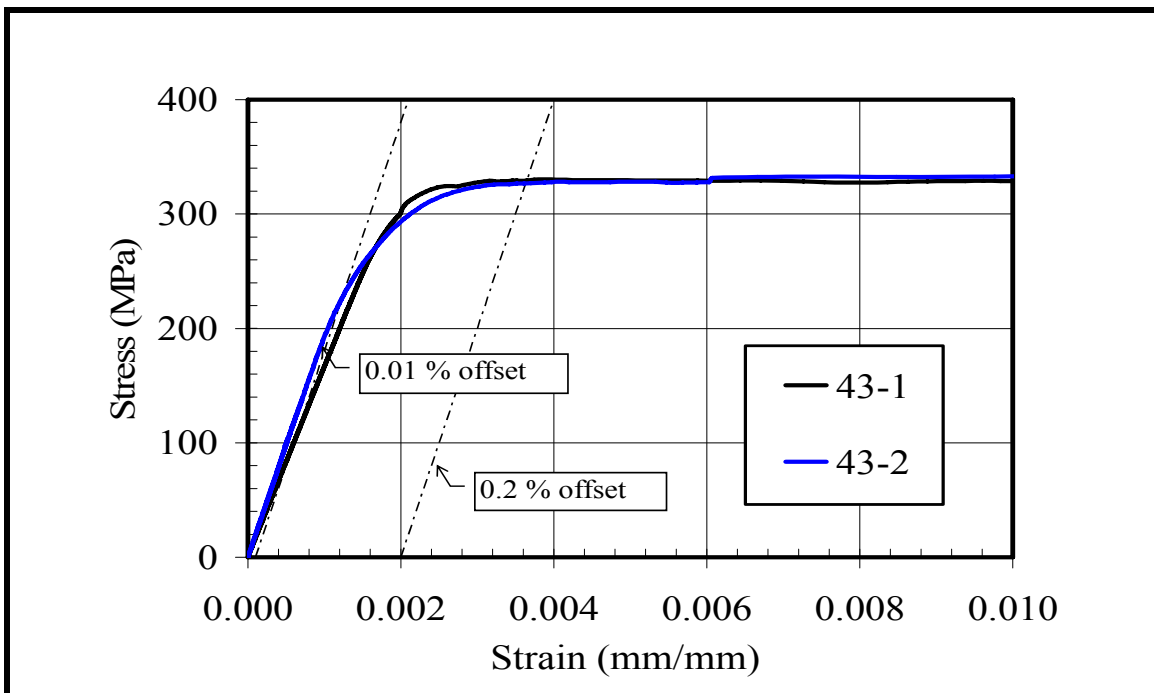

(b)

Figure A.9 Stress-strain relationships -Tension test specimens from 43mils - Channel

APPENDIX – B
COLD-FORMED STEEL JOISTS WITH LARGE WEB OPENINGS
FLEXURAL TESTS

A total of twenty three (23) cold-formed steel (CFS) joist sections were subjected to flexural tests, which established the moment resistances of such sections having a large web opening, and having a reinforced web opening. This investigation considered 43mils (1.092 mm) thick, 8” (203.2 mm) deep joist sections only.

B.1 Flexural Tests: Solid Sections, Circular Openings and Square Openings

The first part of the investigation considered the flexural strength of [a] sections with no openings, [b] sections with a large circular opening, and [c] sections with a large square opening. Three identical tests were done for each case, thus, this part included nine tests. Table B.1.1 summarizes the measured dimensions of the joist sections. Table B.1.2 shows the corresponding moment resistances and the associated failure modes. The load-displacement relations and sample photographs of failed specimens are given in Figures B.1.1 through B.1.6.

B.2 Flexural Tests: Reinforced Circular Openings (Schemes- “A”, “B” and “C”)

The second part of the investigation includes five tests, which considered the flexural strength of sections with reinforced circular opening. Three different reinforcement schemes were considered; [a] solid steel plate (43mils thickness), [b] joist section (43mils thick, 8” deep), and [c] 43mils bridging channels along the top and bottom edges of the opening. Table B.2.1 summarizes the measured dimensions of the joist sections used in this part. Table B.2.2 shows the corresponding moment resistances and the associated failure modes. The load-displacement relations and sample photographs of failed specimens are given in Figures B.2.1 through B.2.6.

B.3 Flexural Tests: Reinforced Square Openings (Schemes- “A”, “B” and “C”)

This part of the investigation considered the sections with reinforced square openings. Three different reinforcement schemes, similar to the circular openings (previous section) were considered. Table B.3.1 summarizes the measured dimensions of the sections corresponding to the nine tests. Table B.3.2 shows the corresponding moment resistances and the associated failure modes. The load-displacement relations associated with the nine tests and sample photographs of failed specimens are given in Figures B.3.1 through B.3.6.

Appendix B.1



Flexural Tests: Solid Sections, Circular Openings and Square Openings

Table B.1.1 Measured dimensions of joist sections

Specimen ID	Cross-Section Dimensions (mm)							
	D	B _c	B _t	d _c	d _t	t'	t	
1	F-N-1-L	201.30	41.14	40.54	10.75	12.92	1.17	1.12
2	F-N-1-R	201.22	40.54	40.50	12.80	10.88	1.14	1.12
3	F-N-2-L	201.08	40.54	40.72	12.90	10.66	1.16	1.12
4	F-N-2-R	201.10	40.93	40.63	10.87	12.87	1.14	1.10
5	F-N-3-L	201.62	41.11	40.55	10.89	12.84	1.16	1.12
6	F-N-3-R	200.94	40.67	40.48	12.89	10.62	1.14	1.10
7	F-C-1-L	201.20	40.97	40.29	10.88	12.79	1.13	1.09
8	F-C-1-R	201.96	40.53	40.46	12.88	10.90	1.14	1.10
9	F-C-2-L	201.16	40.53	40.35	12.90	10.87	1.14	1.10
10	F-C-2-R	201.18	40.65	40.53	12.86	10.78	1.17	1.13
11	F-C-3-L	201.32	40.69	40.55	12.82	10.85	1.17	1.12
12	F-C-3-R	200.90	41.89	40.63	10.52	12.96	1.16	1.12
13	F-S-1-L	201.22	40.51	40.26	12.78	10.91	1.19	1.08
14	F-S-1-R	201.16	40.63	40.23	12.81	10.67	1.13	1.09
15	F-S-2-L	201.26	40.55	40.19	13.11	10.76	1.17	1.12
16	F-S-2-R	201.38	41.14	40.50	10.90	12.80	1.16	1.12
17	F-S-3-L	201.06	41.17	40.39	10.54	12.87	1.14	1.13
18	F-S-3-R	202.04	40.71	40.58	12.90	10.86	1.14	1.10

1 inch = 25.4mm

Table B.1.2 Flexural strength of CFS joists with and without web opening in high moment regions (Flexural Zone)

Test Designation	Moment at Opening Region (kN-m)	Percentage Reduction in Moment Capacity	Sample Pictures	Failure Mode
F-N	Test 1: 4.47 Test 2: 4.37 Test 3: 4.37 Average: 4.40 Standard Deviation: 0.06	0.00 %		Compression flange local buckling at mid-span
F-C	Test 1: 4.22 Test 2: 4.21 Test 3: 3.97 Average: 4.13 Standard Deviation: 0.14	-6.13 %		Compression flange and web local buckling at opening location mid-span
F-S	Test 1: 3.68 Test 2: 3.92 Test 3: 3.75 Average: 3.78 Standard Deviation: 0.12	-14.09 %		Compression flange and web local buckling at opening location mid-span

1 kN.m = 8.85 kips.inch

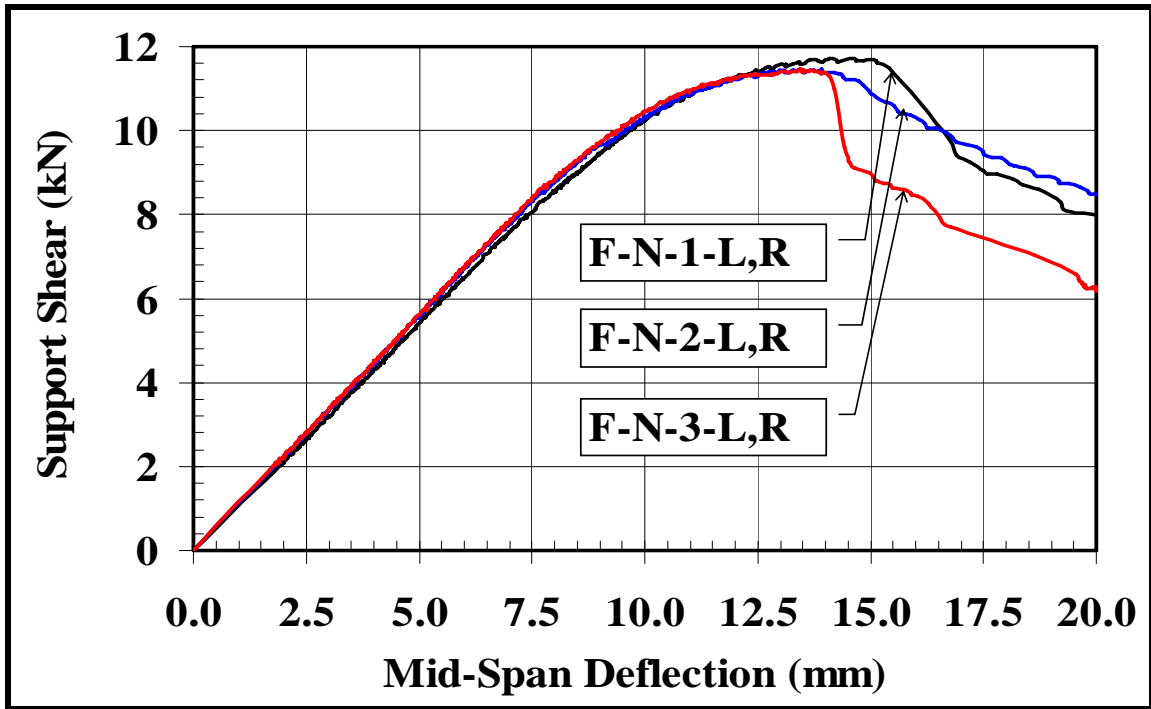

Figure B.1.1 Load-displacement relations for solid specimens

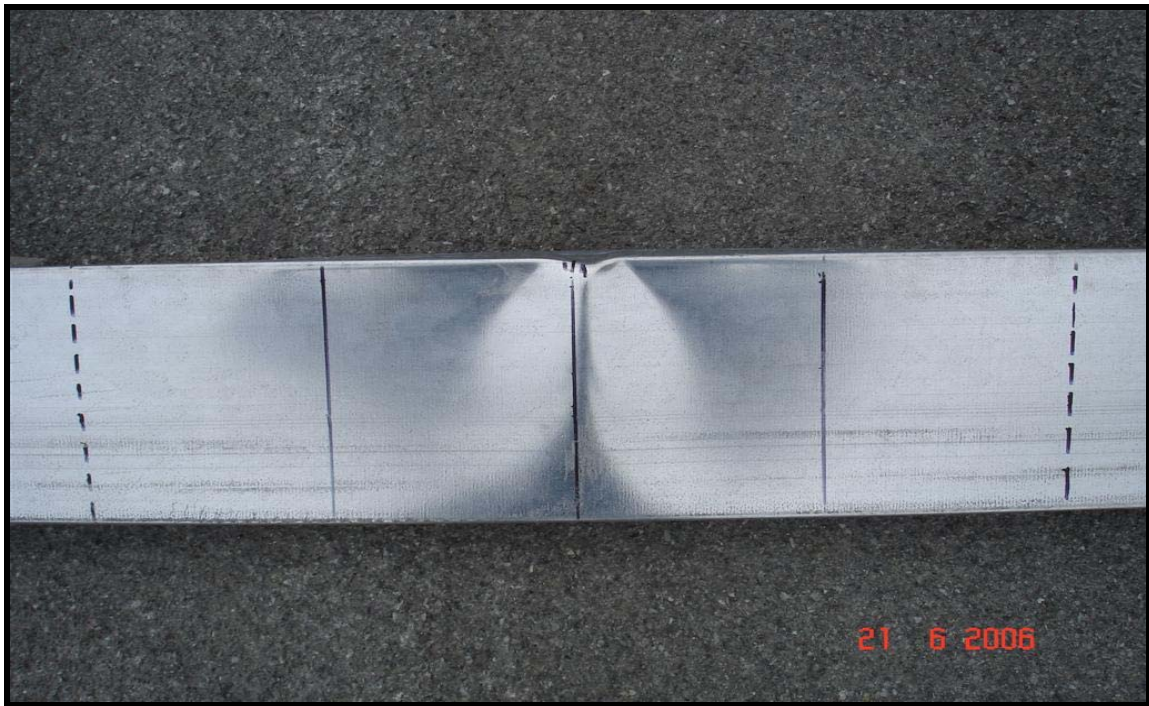

Figure B.1.2 Typical flexural failure for solid specimens

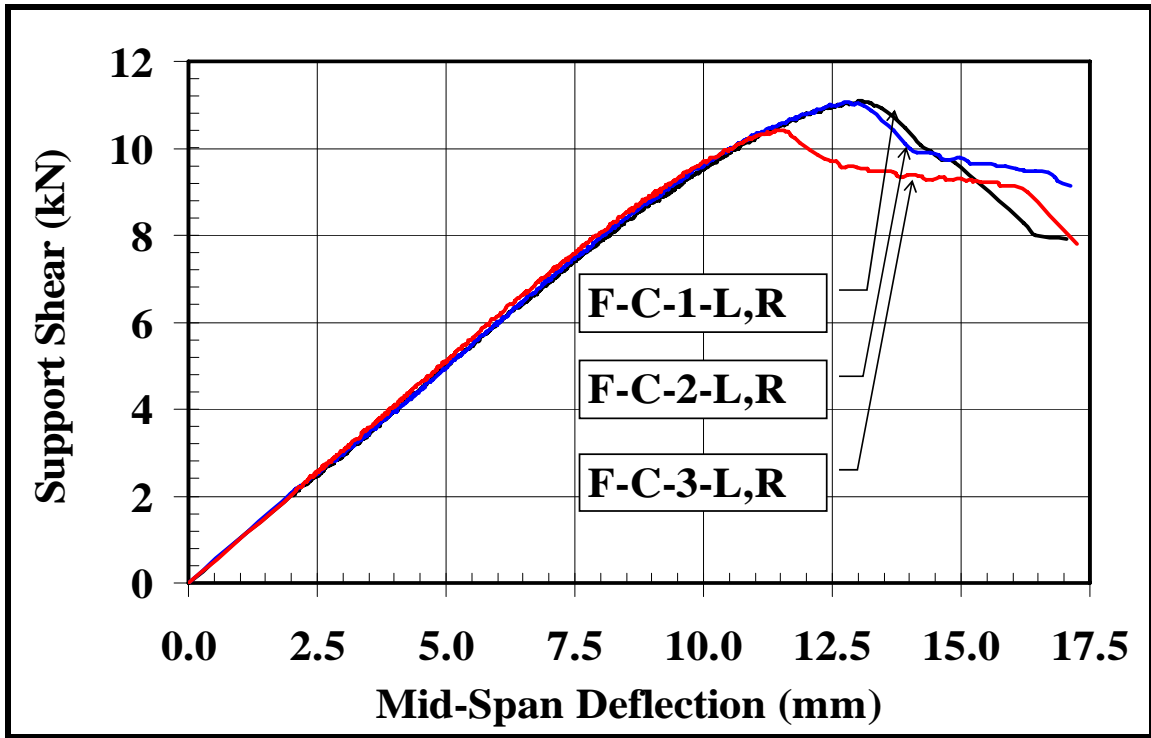

Figure B.1.3 Load-displacement relations for specimens having circular web openings

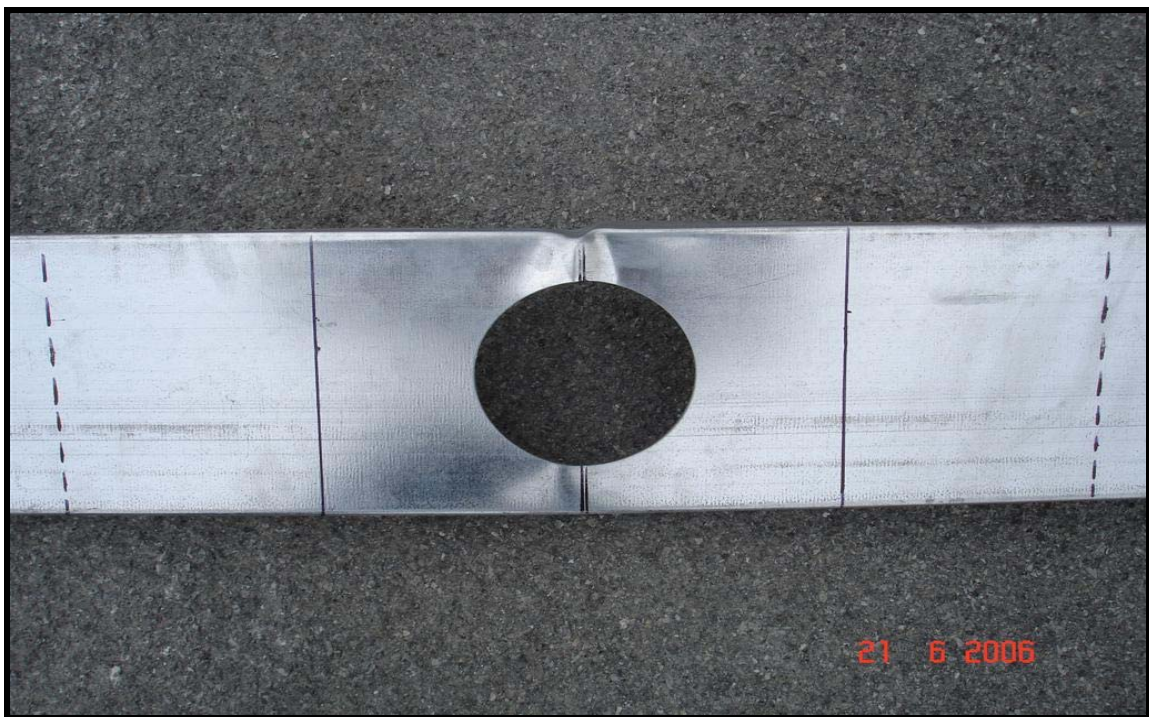

Figure B.1.4 Typical flexural failure for specimens having circular web openings

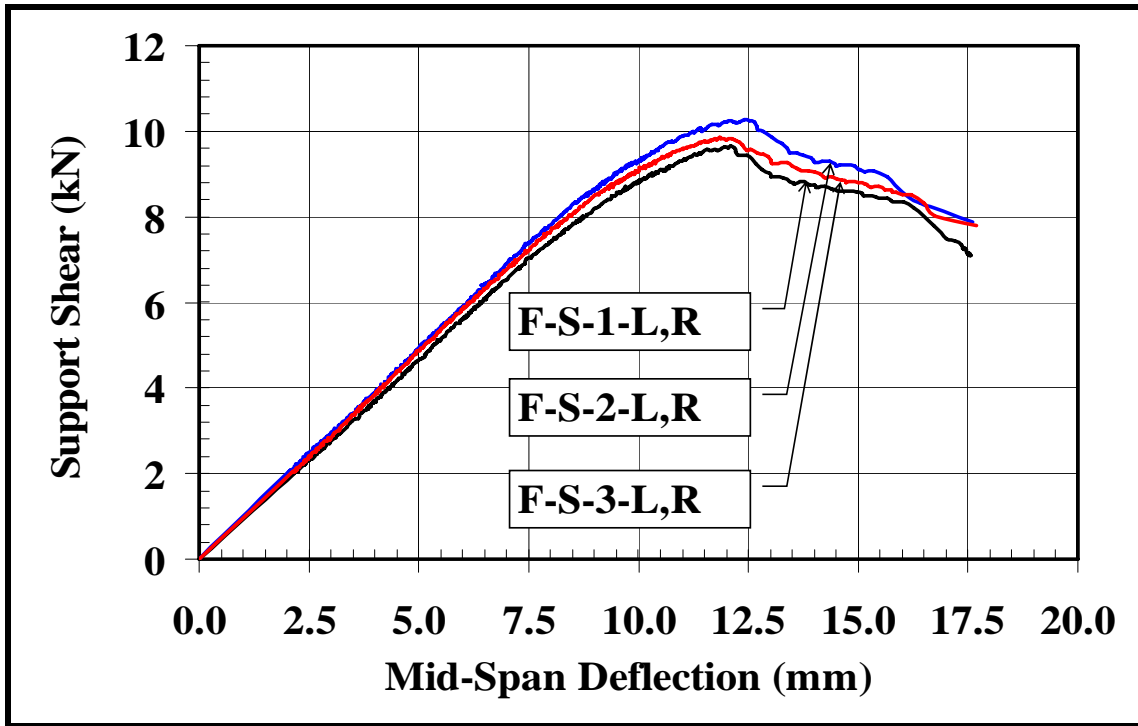

Figure B.1.5 Load-displacement relations for specimens having square web openings

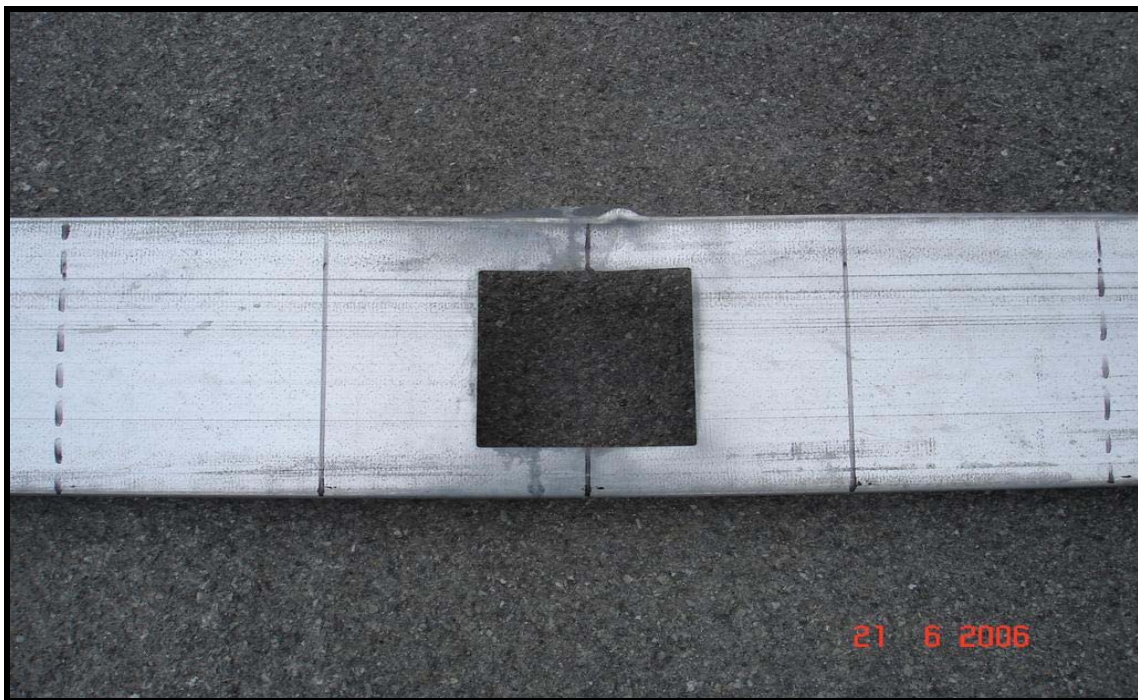

Figure B.1.6 Typical flexural failure for specimens having square web openings

Appendix B.2



Flexural Tests: Reinforced Circular Openings (Schemes- “A”, “B” and “C”)

Table B.2.1 Measured dimensions of joist sections

S.N.	Specimen ID	Cross-Section Dimensions (mm)						
		D	B _c	B _t	d _c	d _t	t'	t
1	F-CR_A-1-L	200.86	40.73	40.34	12.92	10.80	1.14	1.10
2	F-CR_A-1-R	201.90	41.20	40.65	10.91	12.86	1.17	1.13
3	F-CR_B-1-L	201.00	41.23	40.24	10.77	12.85	1.14	1.12
4	F-CR_B-1-R	202.10	40.67	40.50	12.86	10.83	1.16	1.12
5	F-CR_C-1-L	202.00	41.25	40.62	10.99	12.88	1.13	1.09
6	F-CR_C-1-R	201.42	40.61	40.30	12.92	10.84	1.17	1.12
7	F-CR_C-2-L	201.28	41.10	40.73	10.55	12.82	1.16	1.12
8	F-CR_C-2-R	201.34	40.63	40.41	12.90	10.74	1.17	1.12
9	F-CR_C-3-L	201.38	40.74	40.32	12.83	10.91	1.17	1.12
10	F-CR_C-3-R	201.56	40.80	40.40	13.02	10.73	1.14	1.12

1 inch = 25.4mm

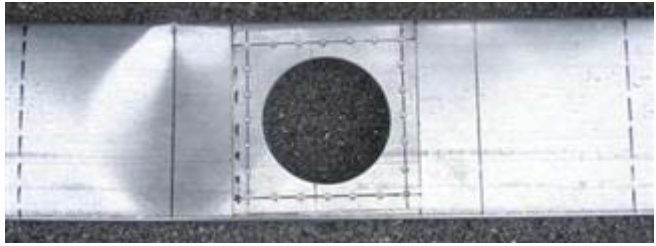
Table B.2.2 Flexural strength of CFS joists with reinforced circular web opening in high moment regions (Flexural Zone)

Test Designation	Moment at Opening Region (kN-m)	Percentage Reduction in Moment Capacity	Sample Pictures	Failure Mode
<p>F-CR_A</p> <p>Plate Reinforcement (Scheme- "A")</p>	<p>Test 1: 4.59 (one test only)</p>	<p>+4.31 %</p>		<p>Compression flange and web local buckling out of reinforced region</p>
<p>F-CR_B</p> <p>Stud Reinforcement (Scheme- "B")</p>	<p>Test 1: 4.58 (one test only)</p>	<p>+4.09 %</p>		<p>Compression flange and web local buckling out of reinforced region</p>
<p>F-CR_C</p> <p>Bridging Channel Reinforcement (Scheme- "C")</p>	<p>Test 1: 4.60 Test 2: 4.59 Test 3: 4.66 Average: 4.62 Standard Deviation: 0.04</p>	<p>+5.00 %</p>		<p>Compression flange and web local buckling out of reinforced region</p>

1 kN.m = 8.85 kips.inch

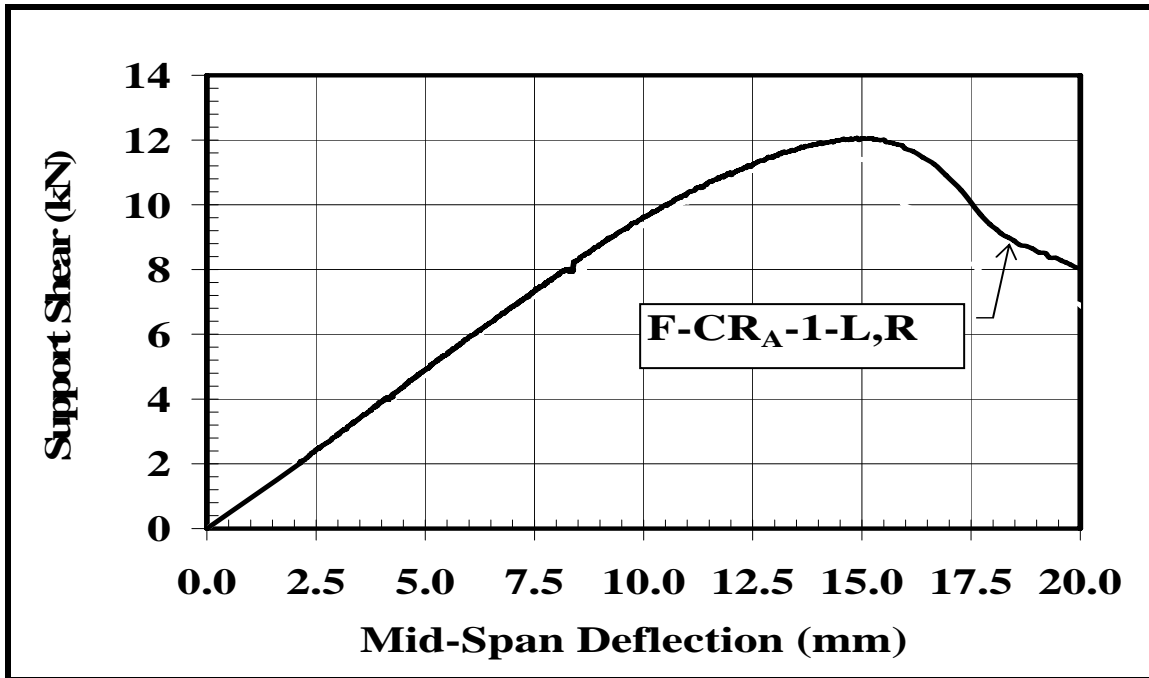

Figure B.2.1 Load-displacement relations for specimens having reinforced (Scheme-“A”) circular web openings

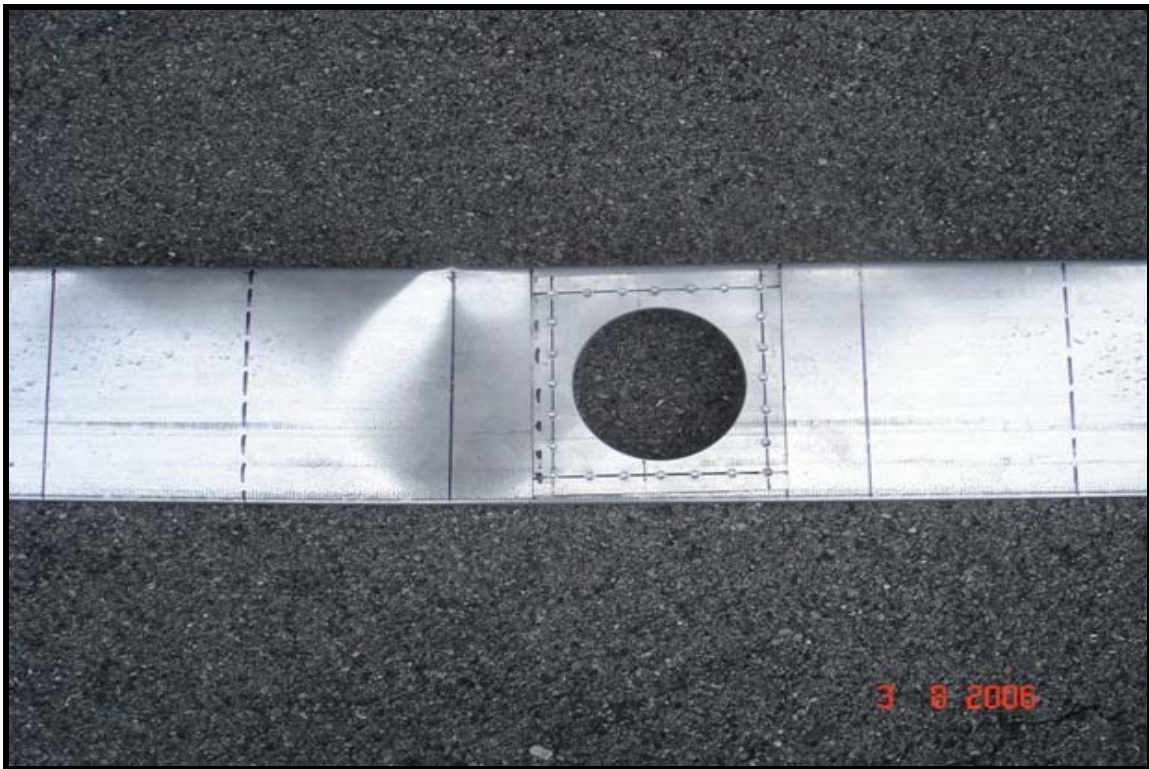

Figure B.2.2 Typical flexural failure for specimens having reinforced (Scheme-“A”) circular web openings

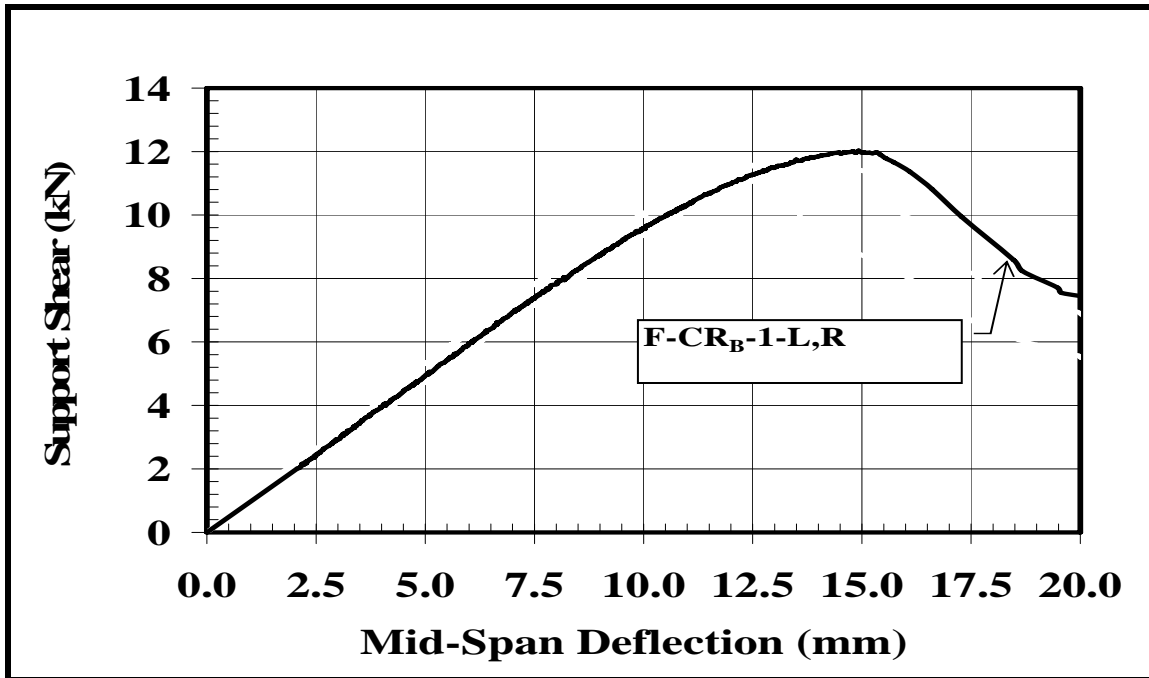

Figure B.2.3 Load-displacement relations for specimens having reinforced (Scheme-“B”) circular web openings

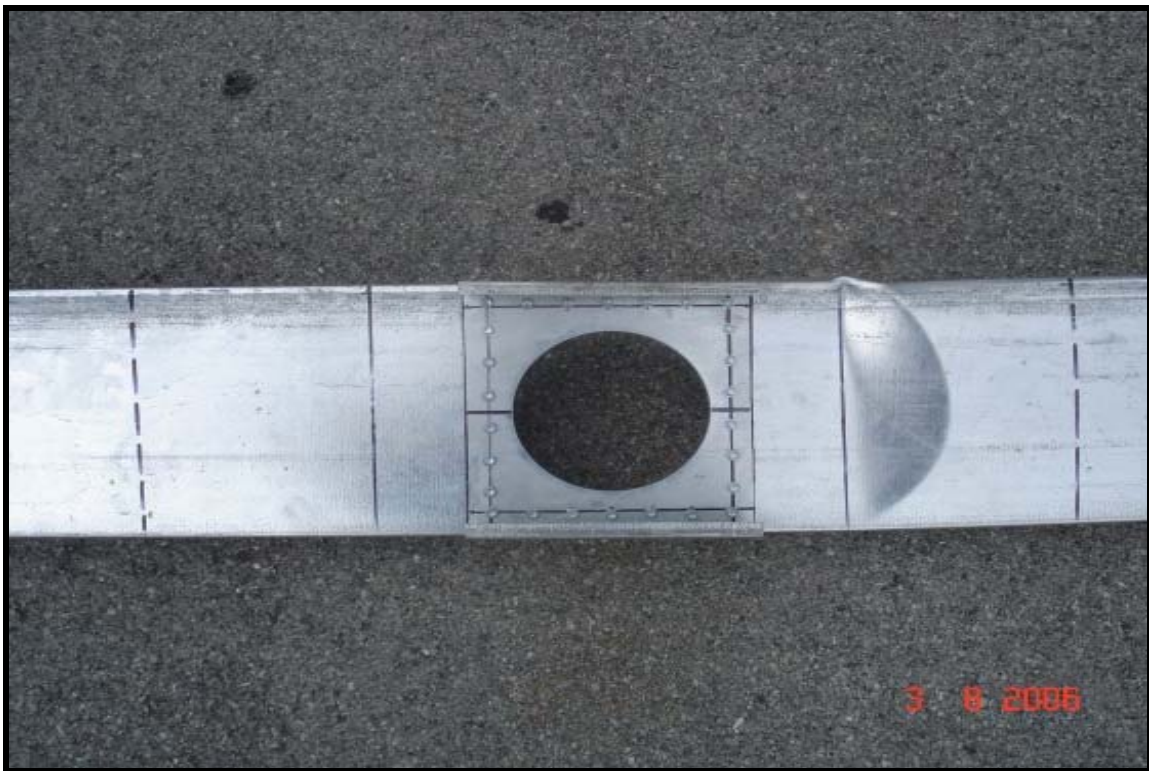

Figure B.2.4 Typical flexural failure for specimens having reinforced (Scheme-“B”) circular web openings

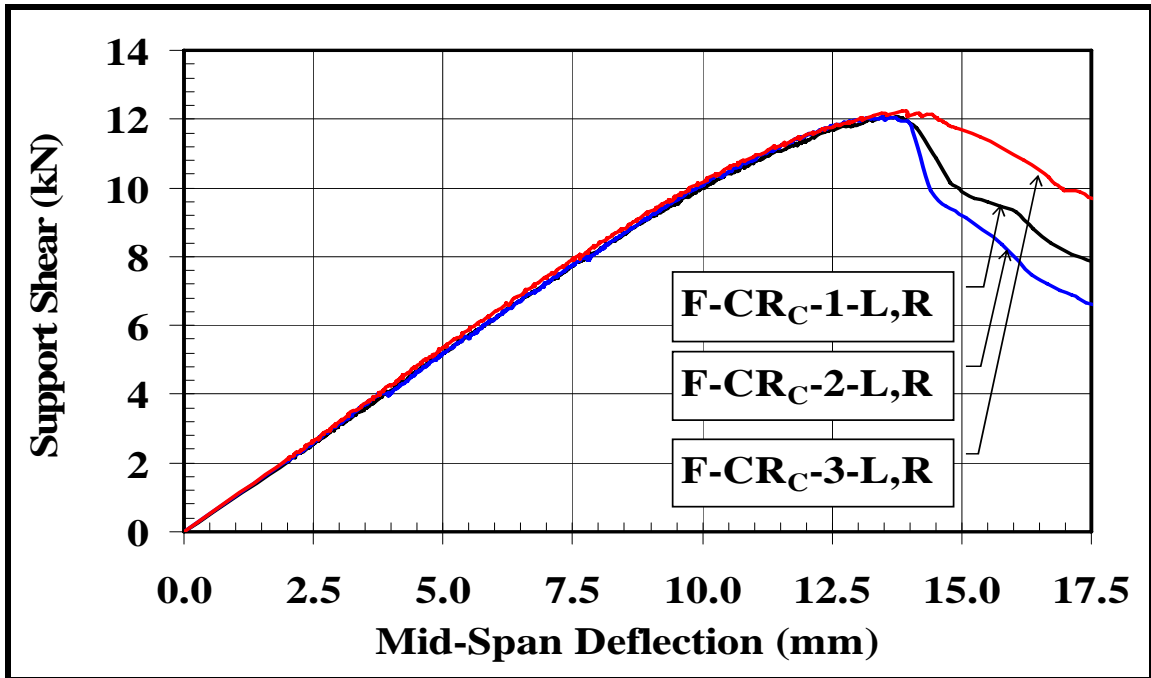

Figure B.2.5 Load-displacement relations for specimens having reinforced (Scheme-“C”) circular web openings



Figure B.2.6 Typical flexural failure for specimens having reinforced (Scheme-“C”) circular web openings

Appendix B.3



Flexural Tests: Reinforced Square Openings (Schemes- “A”, “B” and “C”)

Table B.3.1 Measured dimensions of joist sections

S.N.	Specimen ID	Cross-Section Dimensions (mm)						
		D	B _c	B _t	d _c	d _t	t'	t
1	F-SR _A -1-L	202.06	40.58	40.55	12.93	10.66	1.16	1.12
2	F-SR _A -1-R	201.32	41.10	40.60	10.83	12.79	1.16	1.10
3	F-SR _A -2-L	201.65	41.06	40.37	12.28	10.58	1.16	1.11
4	F-SR _A -2-R	201.49	40.86	40.32	10.14	12.22	1.14	1.11
5	F-SR _A -3-L	201.64	40.68	40.33	12.91	10.90	1.14	1.11
6	F-SR _A -3-R	201.70	40.85	40.46	12.62	10.64	1.15	1.12
7	F-SR _B -1-L	201.40	41.16	40.30	10.86	12.83	1.12	1.09
8	F-SR _B -1-R	201.00	41.06	40.28	10.81	12.80	1.14	1.10
9	F-SR _B -2-L	201.47	41.10	40.33	10.29	12.69	1.15	1.11
10	F-SR _B -2-R	201.24	40.72	40.49	10.99	12.47	1.15	1.11
11	F-SR _B -3-L	201.25	40.66	40.37	12.81	10.60	1.14	1.11
12	F-SR _B -3-R	201.85	41.05	40.37	12.19	10.85	1.15	1.11
13	F-SR _C -1-L	202.06	40.60	40.30	12.83	10.67	1.17	1.12
14	F-SR _C -1-R	201.12	40.56	40.23	12.88	10.75	1.16	1.12
15	F-SR _C -2-L	201.54	41.16	40.45	10.84	12.93	1.14	1.13
16	F-SR _C -2-R	200.94	40.57	40.64	12.84	10.90	1.14	1.12
17	F-SR _C -3-L	202.24	40.63	40.60	12.88	10.88	1.14	1.12
18	F-SR _C -3-R	201.46	41.09	40.20	10.83	12.85	1.13	1.10

1 inch = 25.4mm

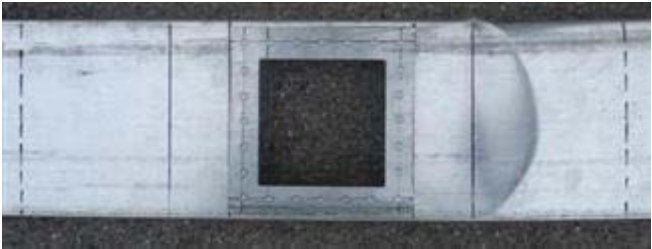
Table B.3.2 Flexural strength of CFS joists with reinforced square web opening in high moment regions (Flexural Zone)

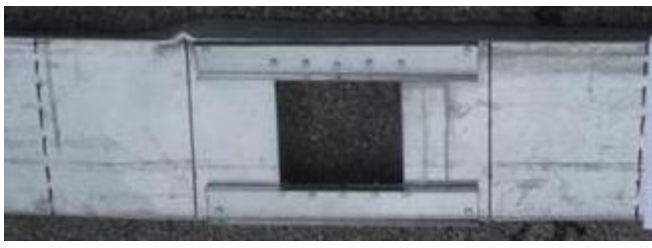
Test Designation	Moment at Opening Region (kN-m)	Percentage Reduction in Moment Capacity	Sample Pictures	Failure Mode
F-SR_A Plate Reinforcement (Scheme- "A")	Test 1: 4.59 Test 2: 4.66 Test 3: 4.57 Average: 4.61 Standard Deviation: 0.05	+4.77 %		Compression flange and web local buckling out of reinforced region
F-SR_B Stud Reinforcement (Scheme- "B")	Test 1: 4.31 Test 2: 4.67 Test 3: 4.63 Average: 4.53 Standard Deviation: 0.20	+2.95 %		Compression flange and web local buckling out of reinforced region
F-CR_C Bridging Channel Reinforcement (Scheme- "B")	Test 1: 4.69 Test 2: 4.45 Test 3: 4.48 Average: 4.54 Standard Deviation: 0.13	+3.18 %		Compression flange local buckling out of reinforced region

1 kN.m = 8.85 kips.inch

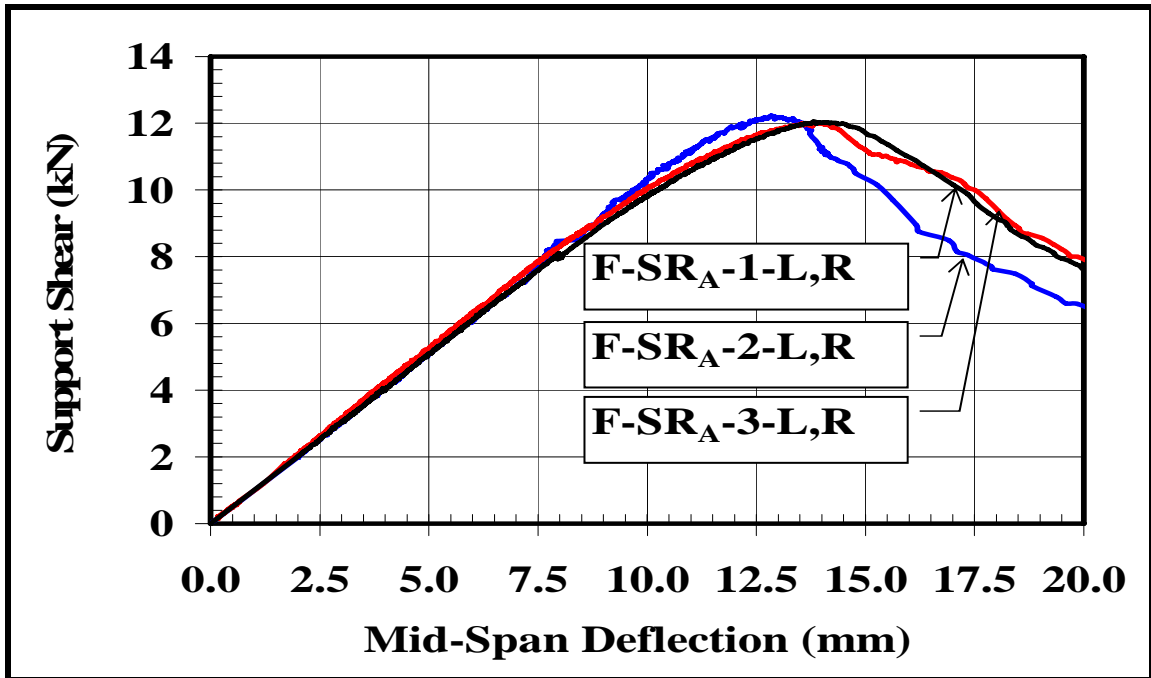

Figure B.3.1 Load-displacement relations for specimens having reinforced (Scheme-“A”) square web openings



Figure B.3.2 Typical flexural failure for specimens having reinforced (Scheme-“A”) square web openings

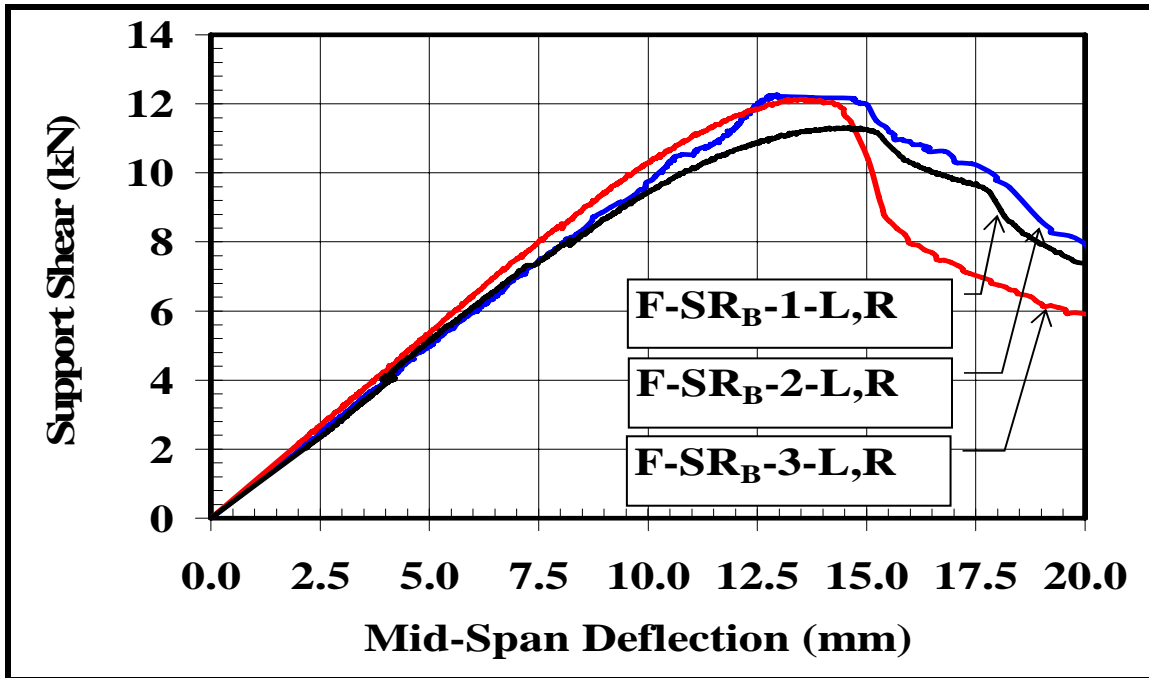

Figure B.3.3 Load-displacement relations for specimens having reinforced (Scheme-“B”) square web openings



Figure B.3.4 Typical flexural failure for specimens having reinforced (Scheme-“B”) square web openings

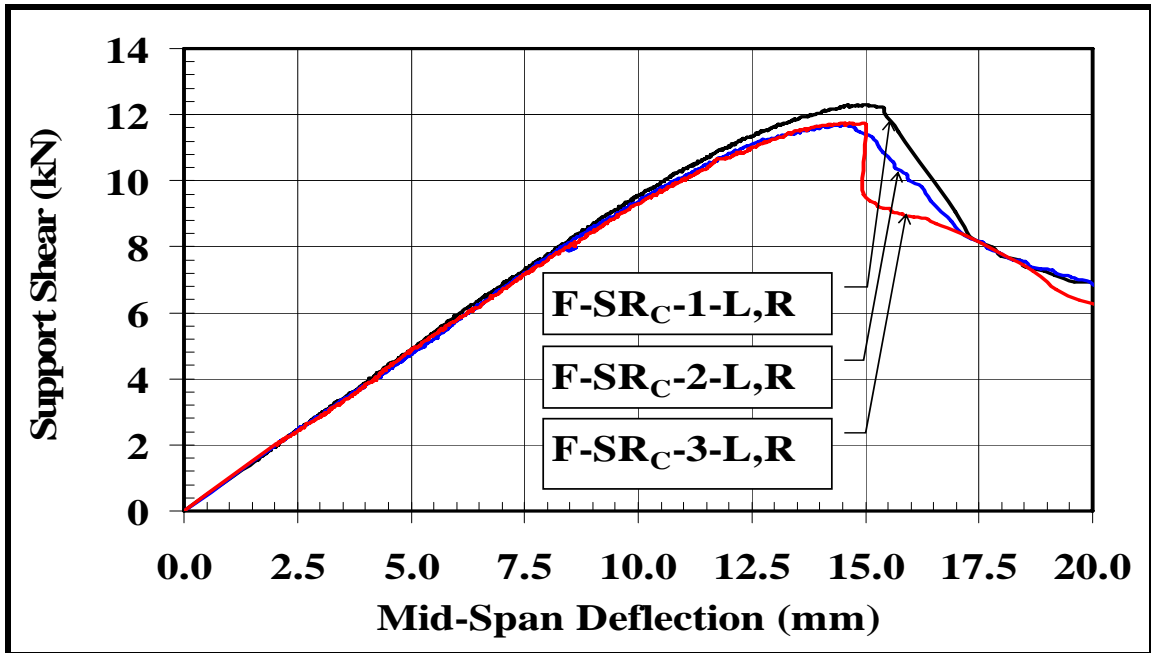

Figure B.3.5 Load-displacement relations for specimens having reinforced (Scheme-“C”) square web openings



Figure B.3.6 Typical flexural failure for specimens having reinforced (Scheme-“C”) square web opening

APPENDIX – C
COLD-FORMED STEEL JOISTS WITH LARGE WEB OPENINGS
SHEAR TESTS

A total of twenty seven cold-formed steel (CFS) joist sections were subjected to short span shear tests, which established the shear resistances of such sections having a large web opening, and having a reinforced web opening. This investigation considered 43mils (1.092 mm) thick, 8” (203.2 mm) deep joist sections only.

C.1 Shear Tests: Solid Sections, Circular Openings and Square Openings

This part of the investigation considered the shear capacity of solid and sections with a large circular opening, and a large square opening. Three identical tests were done for each case, thus, this part included nine tests. Table C.1.1 summarizes the measured dimensions of the joist sections used. Table C.1.2 shows the peak shear experienced by the test specimens and the associated failure modes. The load-displacement relations and sample photographs of failed specimens are given in Figures C.1.1 through C.1.6.

C.2 Shear Tests: Reinforced Circular Openings (Schemes- “A”, “B” and “C”)

Another nine tests considered the shear capacity of sections with reinforced circular opening. Three different reinforcement schemes were considered; [a] solid steel plate (43mils thickness), [b] joist section (43mils thick, 8” deep), and [c] 54mils bridging channels forming a Vierendeel reinforcement arrangement along the edges of the opening. Table C.2.1 summarizes the measured dimensions of the sections used in this part. Table C.2.2 shows the corresponding peak shear loads and the associated failure modes. The load-displacement relations of three identical test specimens and sample photographs of failed specimens are given in Figures C.2.1 through C.2.6.

C.3 Shear Tests: Reinforced Square Openings (Schemes- “A”, “B” and “C”)

This part of the investigation considered the sections with reinforced square openings. Three different reinforcement schemes, as presented in part C.2 were considered. Table C.3.1 summarizes the measured dimensions of the sections corresponding to the nine tests. Table C.3.2 shows the shear resistances of these specimens and the associated failure modes. The load-displacement relations associated with the nine tests and sample photographs of failed specimens are given in Figures C.3.1 through C.3.6.

Appendix C.1



Shear Tests: Solid, Circular Openings and Square Openings

Table C.1.1 Measured dimensions of joist sections

S.N.	Specimen ID	Cross-Section Dimensions (mm)						
		D	B _c	B _t	d _c	d _t	t'	t
1	S-N-1-L	200.98	41.16	40.47	10.92	12.84	1.14	1.12
2	S-N-1-R	202.06	41.24	40.35	10.88	12.93	1.17	1.12
3	S-N-2-L	201.70	40.63	40.43	12.96	10.67	1.14	1.10
4	S-N-2-R	201.16	41.24	40.42	10.84	12.80	1.16	1.12
5	S-N-3-L	201.70	40.73	40.36	12.88	10.72	1.14	1.12
6	S-N-3-R	201.88	40.68	40.51	12.84	10.80	1.13	1.09
7	S-C-1-L	201.08	41.27	40.26	10.95	12.94	1.17	1.12
8	S-C-1-R	201.38	40.60	40.58	12.83	10.68	1.16	1.12
9	S-C-2-L	202.32	40.65	40.29	12.95	10.85	1.16	1.12
10	S-C-2-R	201.16	41.06	40.29	10.74	12.80	1.17	1.12
11	S-C-3-L	201.26	40.66	40.20	13.04	10.73	1.16	1.10
12	S-C-3-R	201.46	41.16	40.40	10.79	12.81	1.14	1.10
13	S-S-1-L	201.12	40.65	40.59	12.97	10.72	1.17	1.12
14	S-S-1-R	201.36	41.06	40.64	10.65	12.88	1.17	1.13
15	S-S-2-L	201.08	40.61	40.34	12.73	10.89	1.17	1.13
16	S-S-2-R	201.48	41.17	40.37	10.47	12.85	1.17	1.12
17	S-S-3-L	202.04	40.66	40.27	12.76	10.79	1.13	1.10
18	S-S-3-R	201.48	41.14	40.61	10.43	12.89	1.14	1.12

1 inch = 25.4mm

Table C.1.2 Shear strength of CFS joists with and without web opening in high shear region (Shear Zone)

Test Designation	Peak Shear at Opening Region (kN)	Percentage Reduction in Shear Capacity	Sample Pictures	Failure Mode
S-N	Test 1: 12.23 Test 2: 12.56 Test 3: 12.49 Average: 12.43 Standard Deviation: 0.17	0.00 %		Primarily shear failure mixed in with flexural failure.
S-C	Test 1: 7.37 Test 2: 7.45 Test 3: 7.48 Average: 7.43 Standard Deviation: 0.06	-40.22 %		Shear diagonal failure
S-S	Test 1: 5.10 Test 2: 5.27 Test 3: 5.06 Average: 5.14 Standard Deviation: 0.11	-58.65 %		Shear diagonal failure

1 kN = 0.225 kip

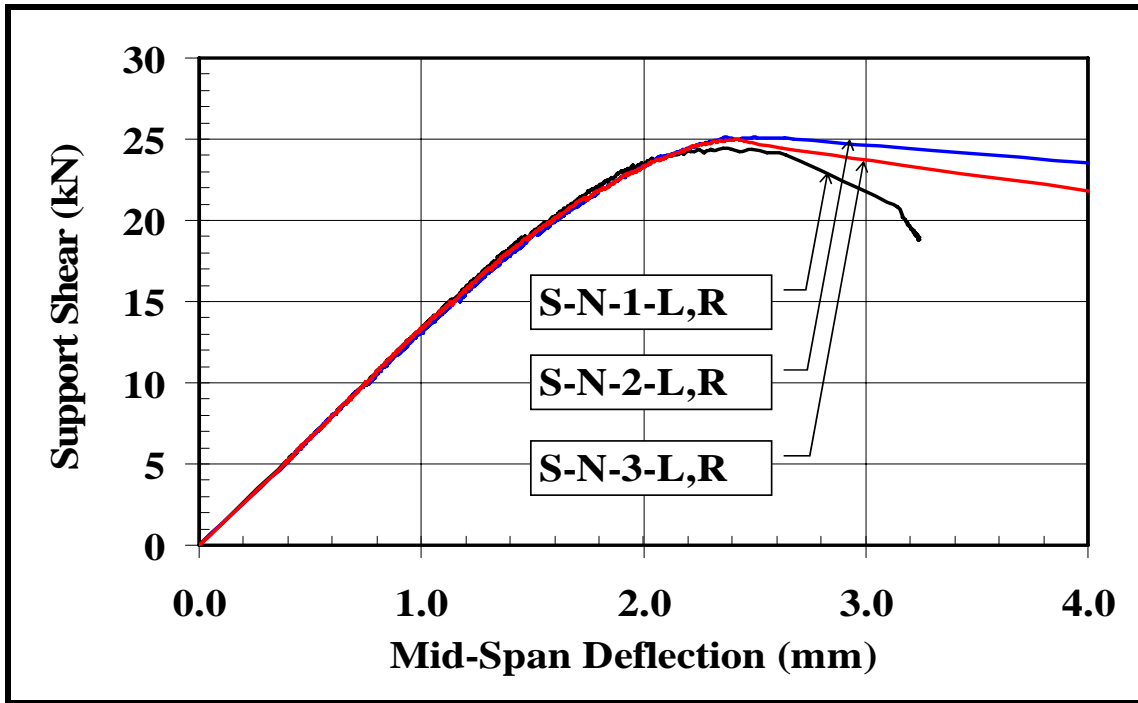

Figure C.1.1 Load-displacement relations for solid specimens

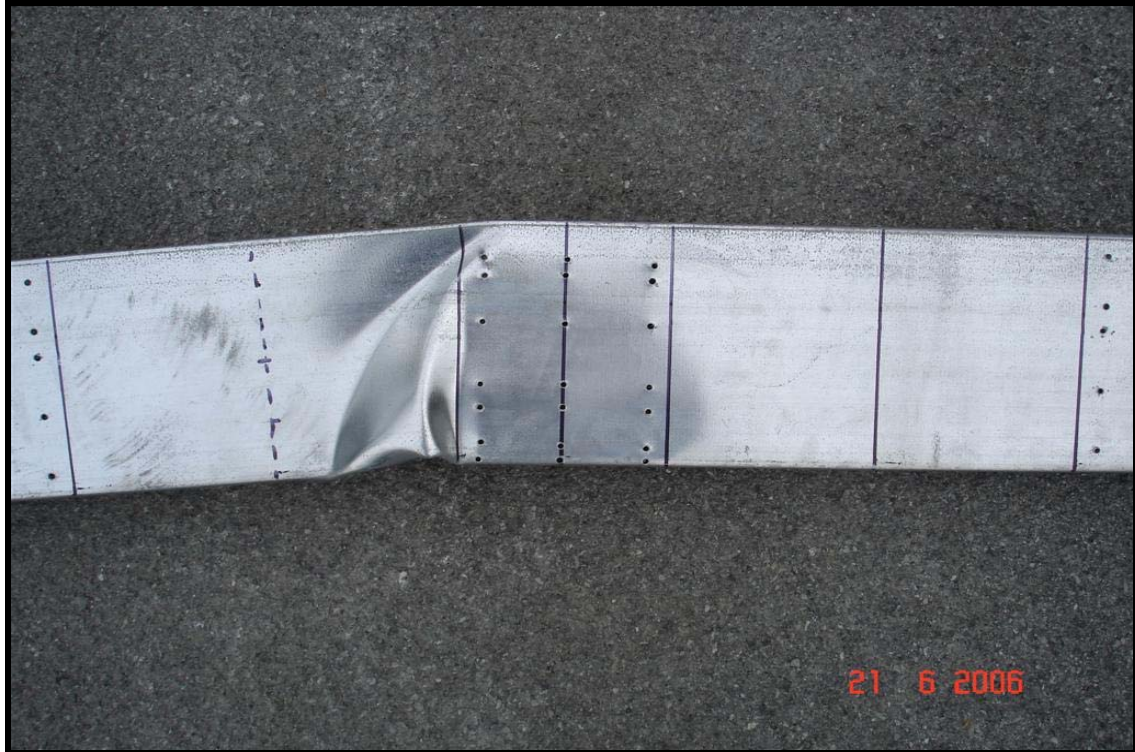

Figure C.1.2 Typical failure for solid specimens

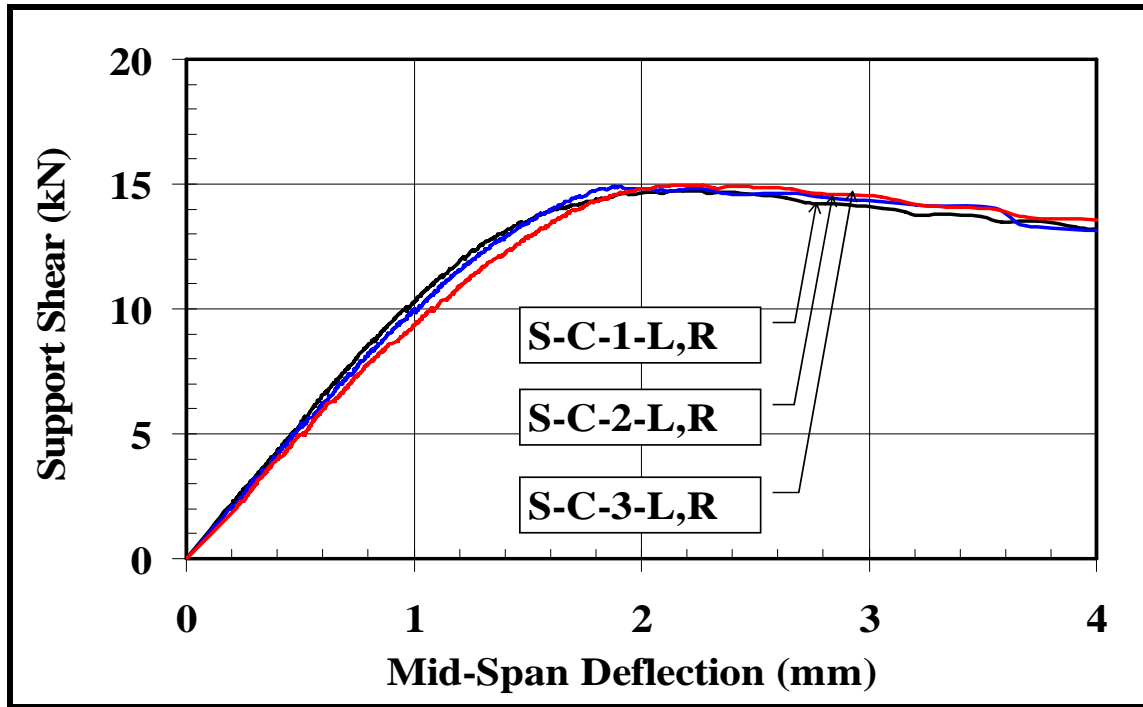

Figure C.1.3 Load-displacement relations for specimens having circular web openings

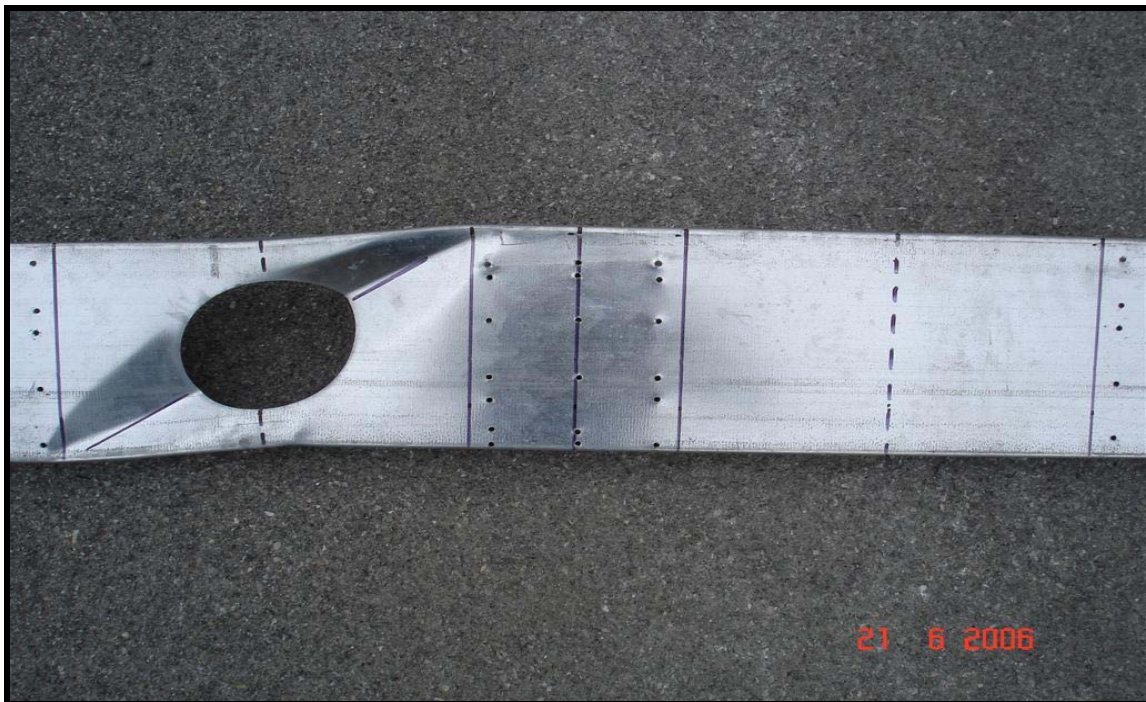

Figure C.1.4 Typical shear failure for specimens having circular web openings

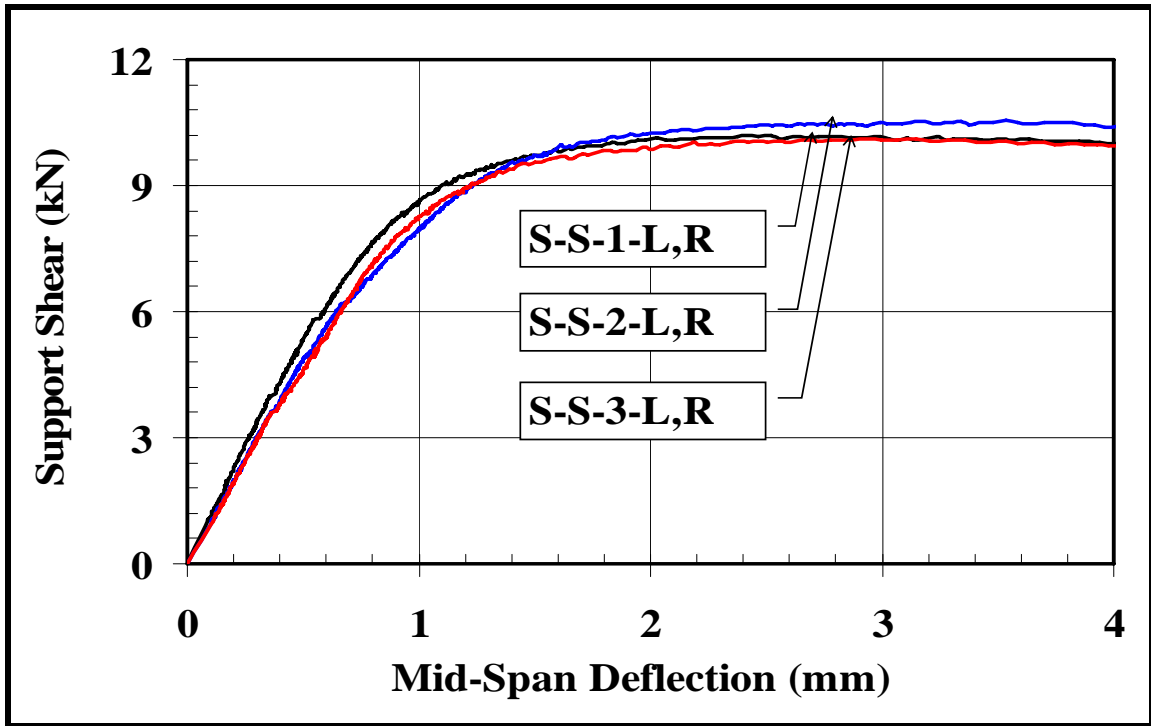

Figure C.1.5 Load-displacement relations for specimens having square web openings

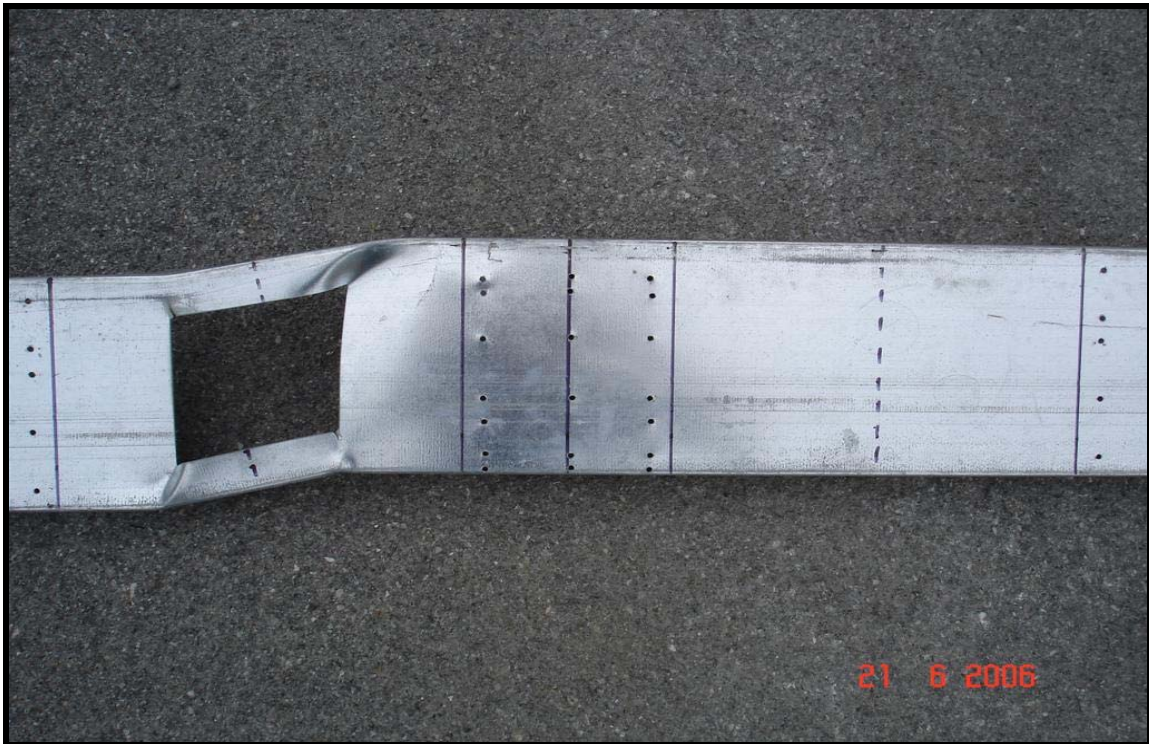

Figure C.1.6 Typical shear failure for specimens having square web openings

Appendix C.2



Shear Tests: Reinforced Circular Openings (Schemes- “A”, “B” and “C”)

Table C.2.1 Measured dimensions of joist sections

S.N.	Specimen ID	Cross-Section Dimensions (mm)						
		D	B _c	B _t	d _c	d _t	t'	t
1	S-CR _A -1-L	201.18	40.67	40.60	12.63	10.91	1.16	1.12
2	S-CR _A -1-R	201.72	40.64	40.58	12.86	10.91	1.14	1.13
3	S-CR _A -2-L	201.13	40.71	40.33	10.76	12.46	1.14	1.12
4	S-CR _A -2-R	201.20	40.77	40.55	12.09	10.62	1.14	1.10
5	S-CR _A -3-L	201.87	40.92	40.58	12.50	10.20	1.16	1.11
6	S-CR _A -3-R	201.24	40.84	40.39	12.46	10.82	1.16	1.11
7	S-CR _B -1-L	201.42	41.13	40.54	10.86	12.88	1.14	1.12
8	S-CR _B -1-R	202.28	40.72	40.48	12.88	10.64	1.14	1.12
9	S-CR _B -2-L	201.51	40.61	40.36	10.07	12.17	1.14	1.12
10	S-CR _B -2-R	201.39	40.70	40.63	10.67	12.60	1.16	1.12
11	S-CR _B -3-L	201.86	41.03	40.37	12.33	10.41	1.15	1.10
12	S-CR _B -3-R	201.41	40.73	40.49	12.61	10.61	1.15	1.12
13	S-CR _C -1-L	200.76	41.14	40.62	10.46	12.95	1.14	1.10
14	S-CR _C -1-R	201.20	40.63	40.57	12.81	10.66	1.17	1.13
15	S-CR _C -2-L	201.34	41.26	40.58	10.90	12.90	1.16	1.12
16	S-CR _C -2-R	201.80	40.57	40.35	12.88	10.75	1.14	1.10
17	S-CR _C -3-L	202.16	41.33	40.58	10.75	12.84	1.14	1.12
18	S-CR _C -3-R	201.66	40.64	40.70	12.62	10.72	1.14	1.12

1 inch = 25.4mm

Table C.2.2 Shear strength of CFS joists with reinforced circular web opening in high shear region (Shear Zone)

Test Designation	Peak Shear at Opening Region (kN)	Percentage Reduction in Shear Capacity	Sample Pictures	Failure Mode
<p>S-CR_A</p> <p>Plate Reinforcement (Scheme-“A”)</p>	<p>Test 1: 11.52 Test 2: 11.12 Test 3: 11.06</p> <p>Average: 11.52 Standard Deviation: 0.25</p>	-7.32 %		Shear diagonal failure at the opening
<p>S-CR_B</p> <p>Stud Reinforcement (Scheme-“B”)</p>	<p>Test 1: 12.46 Test 2: 12.05 Test 3: 11.98</p> <p>Average: 12.46 Standard Deviation: 0.11</p>	+0.24 %		Shear diagonal failure at opening + shear-flexural failure out of the opening
<p>S-CR_C</p> <p>Bridging Channel Reinforcement (Scheme-“C”)</p>	<p>Test 1: 12.77 Test 2: 12.86 Test 3: 13.22</p> <p>Average: 12.95 Standard Deviation: 0.24</p>	+4.18 %		Shear + flexural failure out of the opening

1 kN = 0.225 kip

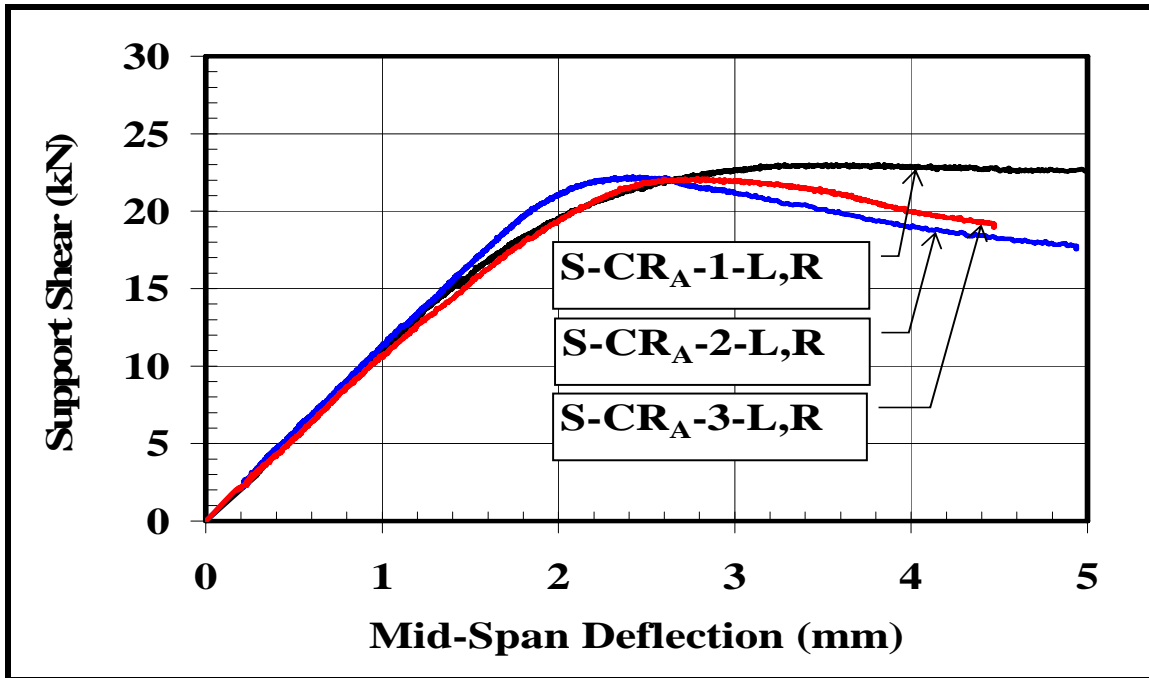

Figure C.2.1 Load-displacement relations for specimens having reinforced (Scheme-“A”) circular web openings



Figure C.2.2 Typical failure for specimens having reinforced (Scheme-“A”) circular web openings

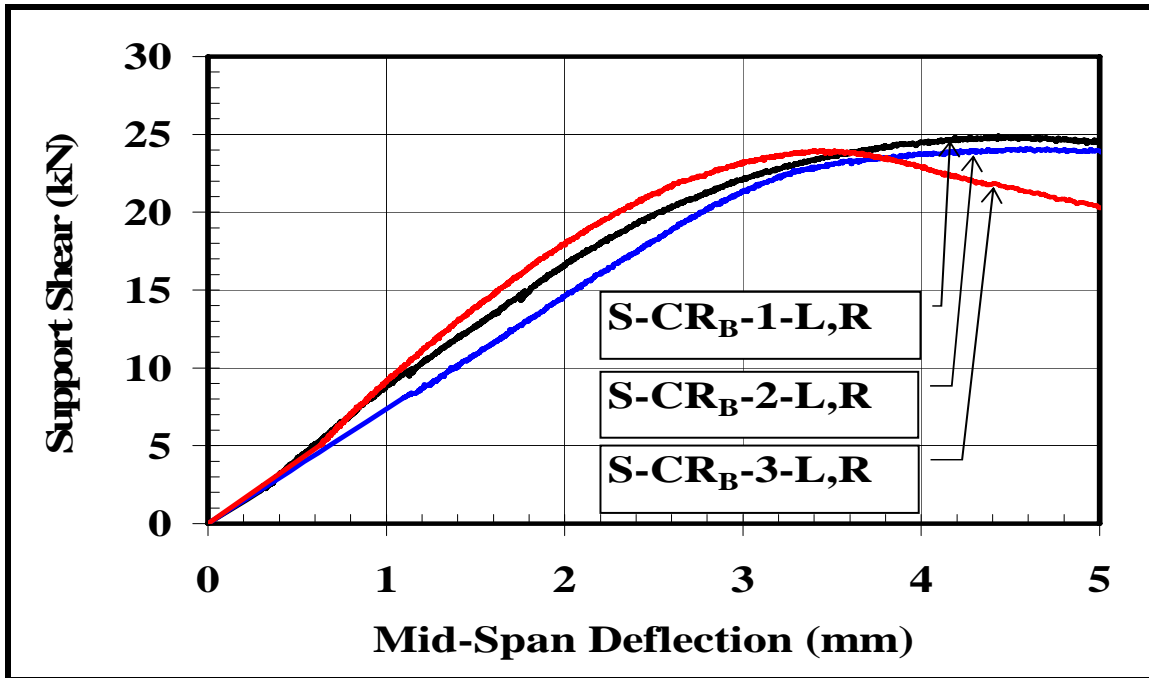

Figure C.2.3 Load-displacement relations for specimens having reinforced (Scheme-“B”) circular web openings



Figure C.2.4 Typical failure for specimens having reinforced (Scheme-“B”) circular web openings

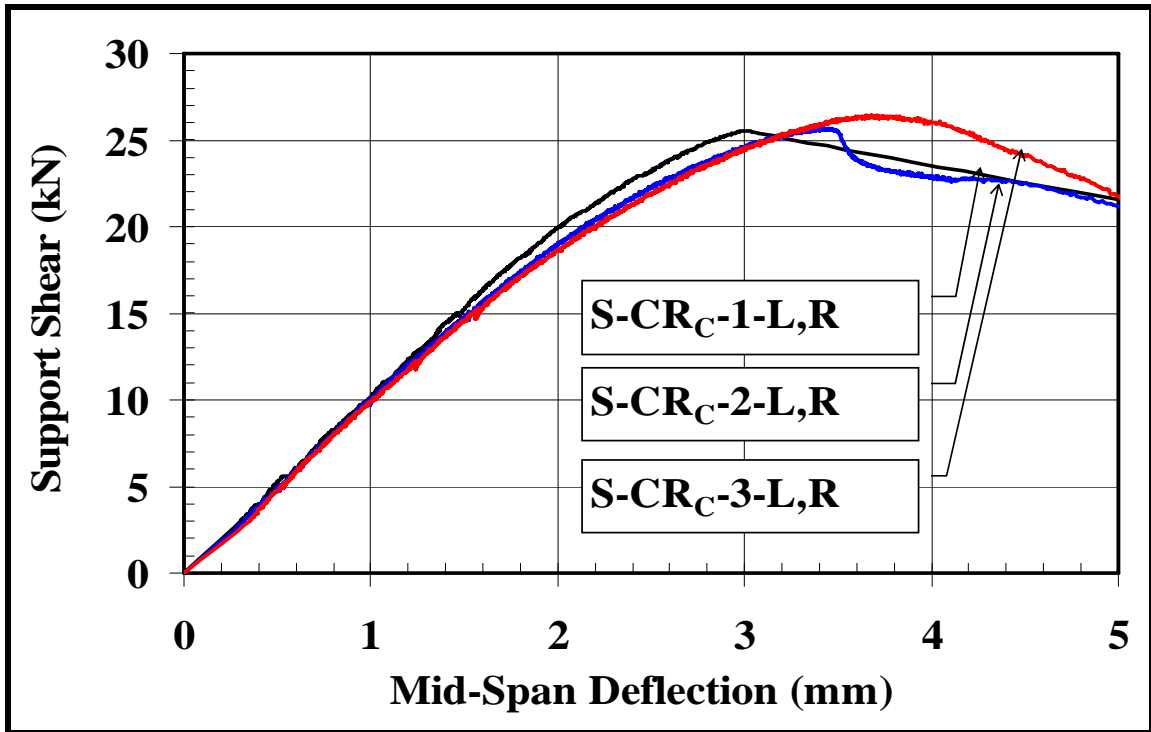

Figure C.2.5 Load-displacement relations for specimens having reinforced (Scheme-“C”) circular web openings

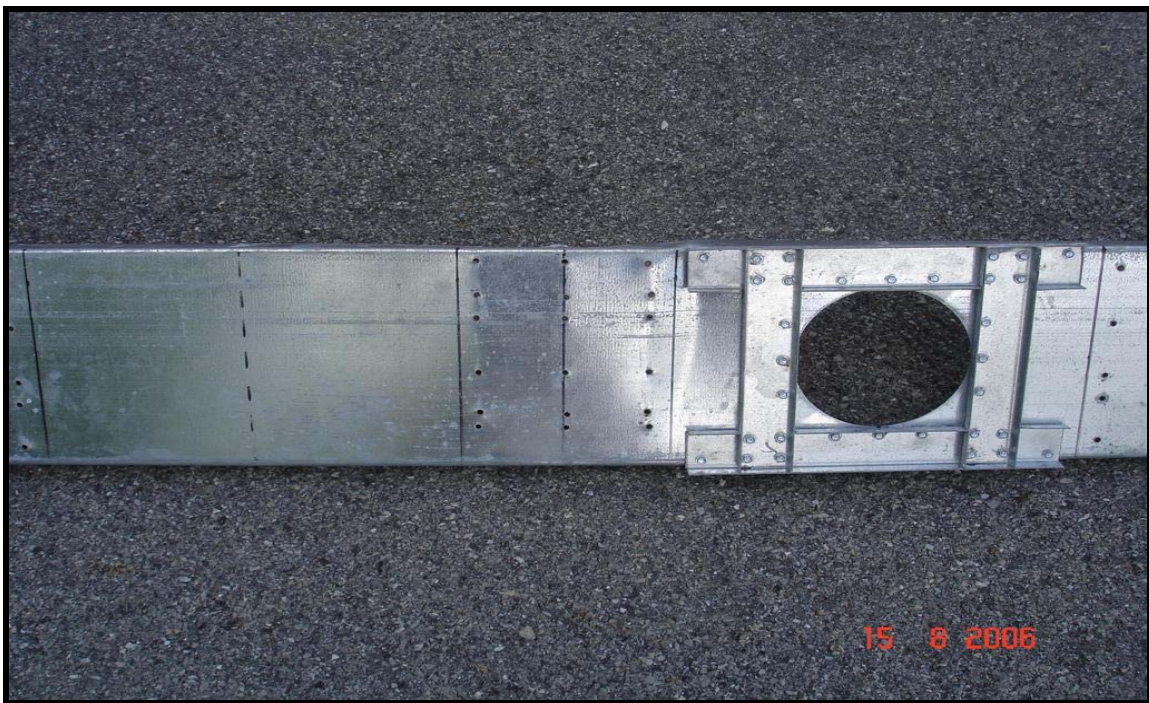

Figure C.2.6 Typical failure for specimens having reinforced (Scheme-“C”) circular web openings



Appendix C.3 Shear Tests: Reinforced Square Openings (Schemes- “A”, “B” and “C”)

Table C.3.1 Measured dimensions of joist sections

S.N.	Specimen ID	Cross-Section Dimensions (mm)						
		D	B _c	B _t	d _c	d _t	t'	t
1	S-SR _A -1-L	201.56	41.06	40.62	12.82	10.69	1.14	1.13
2	S-SR _A -1-R	201.22	40.51	40.21	12.78	10.86	1.19	1.08
3	S-SR _A -2-L	201.81	40.62	40.42	12.80	10.50	1.15	1.11
4	S-SR _A -2-R	201.96	40.95	40.48	12.07	10.01	1.16	1.12
5	S-SR _A -3-L	201.62	40.92	40.54	12.93	10.99	1.14	1.12
6	S-SR _A -3-R	201.48	40.68	40.33	10.39	12.16	1.14	1.12
7	S-SR _B -1-L	202.32	40.76	40.32	12.88	10.62	1.13	1.10
8	S-SR _B -1-R	202.88	41.23	40.58	10.81	12.83	1.12	1.10
9	S-SR _B -2-L	201.21	40.89	40.55	12.85	10.37	1.16	1.11
10	S-SR _B -2-R	201.73	40.93	40.33	12.65	10.69	1.14	1.12
11	S-SR _B -3-L	201.89	41.00	40.56	12.28	10.23	1.16	1.12
12	S-SR _B -3-R	201.13	40.88	40.61	10.24	12.06	1.16	1.12
13	S-SR _C -1-L	201.56	40.66	40.64	13.10	10.71	1.14	1.12
14	S-SR _C -1-R	201.32	41.34	40.23	10.93	12.76	1.16	1.12
15	S-SR _C -2-L	201.36	40.65	40.71	12.86	10.86	1.14	1.12
16	S-SR _C -2-R	200.98	41.23	40.55	10.82	12.93	1.14	1.10
17	S-SR _C -3-L	201.58	41.25	40.51	10.72	12.85	1.14	1.12
18	S-SR _C -3-R	200.94	40.51	40.32	12.89	10.89	1.16	1.13

1 inch = 25.4mm

Table C.3.2 Shear strength of CFS joists with reinforced square web opening in high shear region (Shear Zone)

Test Designation	Peak Shear at Opening Region (kN)	Percentage Reduction in Shear Capacity	Sample Pictures	Failure Mode
<p>S-SR_A</p> <p>Plate Reinforcement (Scheme-“A”)</p>	<p>Test 1: 8.40 Test 2: 8.22 Test 3: 7.63</p> <p>Average: 8.08 Standard Deviation: 0.40</p>	-35.00 %		Shear diagonal failure at opening
<p>S-SR_B</p> <p>Stud Reinforcement (Scheme-“B”)</p>	<p>Test 1: 9.25 Test 2: 8.11 Test 3: 8.18</p> <p>Average: 8.52 Standard Deviation: 0.64</p>	-31.57 %		Shear diagonal failure at opening
<p>S-SR_C</p> <p>Bridging Channel Reinforcement (Scheme-“C”)</p>	<p>Test 1: 12.44 Test 2: 12.61 Test 3: 12.47</p> <p>Average: 12.50 Standard Deviation: 0.09</p>	+0.56 %		Shear + flexural failure out of opening

1 kN = 0.225 kip

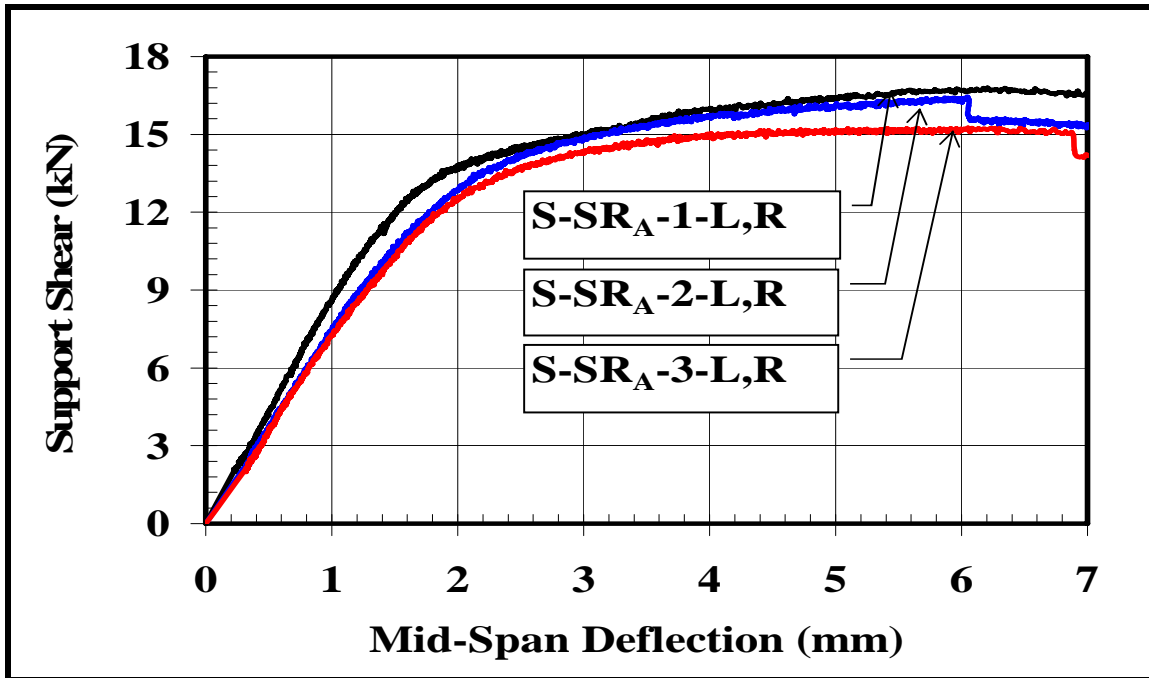

Figure C.3.1 Load-displacement relations for specimens having reinforced (Scheme-“A”) square web openings



Figure C.3.2 Typical failure for specimens having reinforced (Scheme-“A”) square web openings

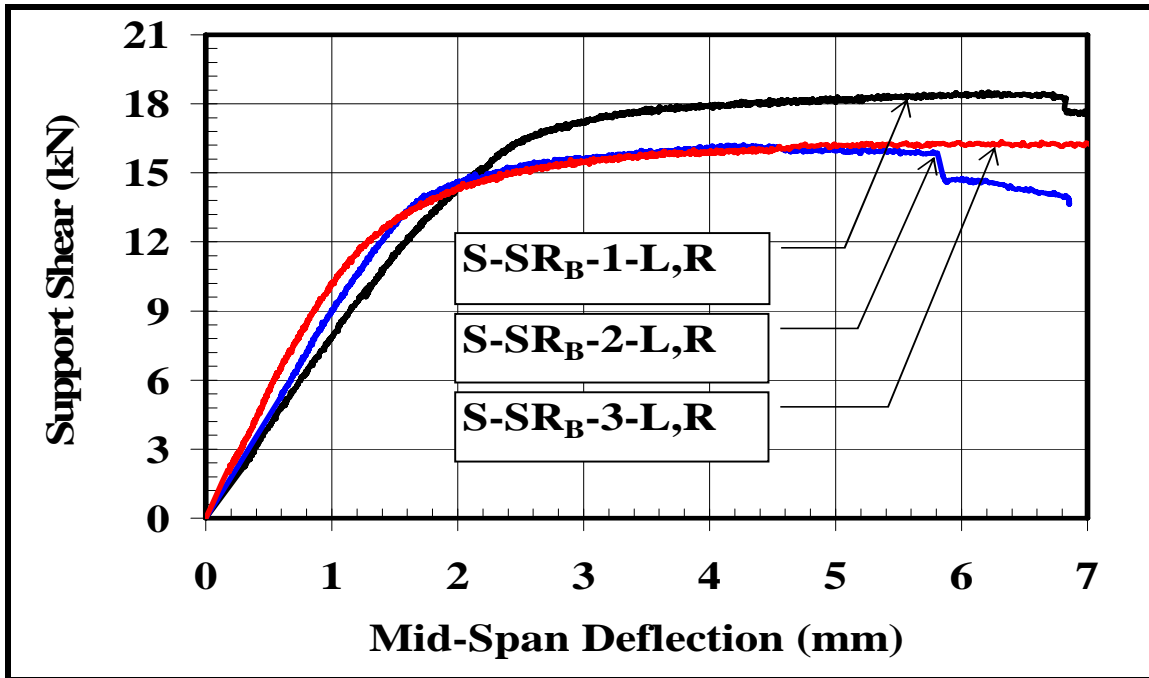

Figure C.3.3 Load-displacement relations for specimens having reinforced (Scheme-“B”) square web openings



Figure C.3.4 Typical failure for specimens having reinforced (Scheme-“B”) square web openings

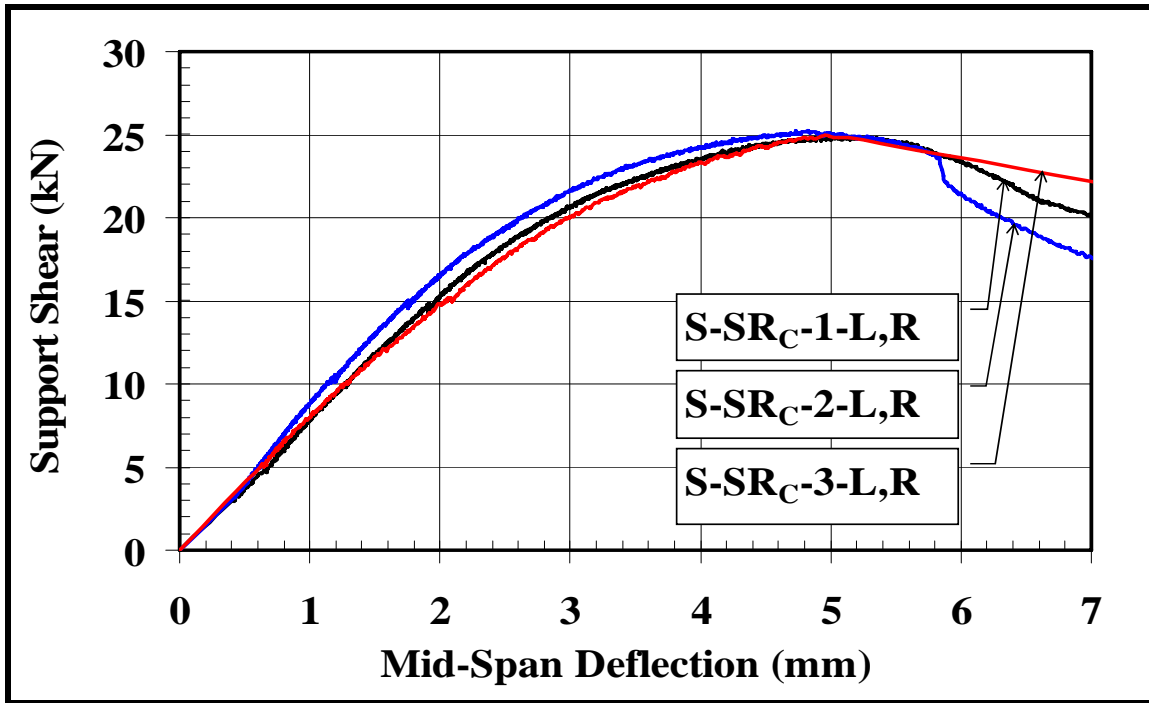

Figure C.3.5 Load-displacement relations for specimens having reinforced (Scheme-“C”) square web openings



Figure C.3.6 Typical failure for specimens having reinforced (Scheme-“C”) square web openings



American Iron and Steel Institute

1140 Connecticut Avenue, NW
Suite 705
Washington, DC 20036
www.steel.org



Steel Framing Alliance™

Steel. The Better Builder.

1201 15th Street, NW
Suite 320
Washington, DC 20005
www.steel framing.org

