

**Axial Strength of Purlins  
Attached to Standing Seam  
Roof Panels**

**RESEARCH REPORT RP01-8**

**MAY 2001  
REVISION 2006**

Committee on Specifications  
for the Design of Cold-Formed  
Steel Structural Members



**American Iron and Steel Institute**

The material contained herein has been developed by researchers based on their research findings. The material has also been reviewed by the American Iron and Steel Institute Committee on Specifications for the Design of Cold-Formed Steel Structural Members. The Committee acknowledges and is grateful for the contributions of such researchers.

The material herein is for general information only. The information in it should not be used without first securing competent advice with respect to its suitability for any given application. The publication of the information is not intended as a representation or warranty on the part of the American Iron and Steel Institute, or of any other person named herein, that the information is suitable for any general or particular use or of freedom from infringement of any patent or patents. Anyone making use of the information assumes all liability arising from such use.

Research Report

AXIAL STRENGTH OF PURLINS ATTACHED TO  
STANDING SEAM ROOF PANELS

by

John A. Stolarczyk

James M. Fisher  
Principal Investigator

Submitted to

Metal Building Manufacturers Association  
1300 Sumner Ave.  
Cleveland, OH 44115-2851

American Iron and Steel Institute  
1001 17<sup>th</sup> Street, N.W. Suite 1300  
Washington, D.C. 20036-4700

MBMA 99-02

Report No. 980531JMF

Computerized Structural Design, S.C.  
8989 North Port Washington Road  
Milwaukee, WI 53217-1633

May 2001  
Revised August 2001

## ABSTRACT

The purpose of this research was to determine the axial load capacity of Z-purlins with one flange attached to a standing seam roof system. The axial load capacity was determined by developing a relationship between the flexural uplift buckling strength and the axial buckling strength in the Z-purlin. This relationship was investigated using finite element models and by conducting a parametric study. At the conclusion of the parametric study, confirmatory tests were conducted to verify the finite element results. Lastly, a relationship has been provided that relates the axial buckling strength in the Z-purlin to the flexural uplift buckling strength.

## ACKNOWLEDGEMENTS

This report was prepared for the AISI Committee on Specifications for the Design of Cold-Formed Steel Structural Members and Metal Building Manufacturers Association.

I would like to extend a special thanks to everyone involved in this research, for without them this would not have been possible.

First and foremost, I would like to thank the sponsors of this research, the American Iron and Steel Institute (AISI) and the Metal Building Manufacturers Association (MBMA). Without their financial support this research would not have been possible.

Thank you to Richard C. Kaehler, P.E. and James M. Fisher, Ph.D., P.E., of Computerized Structural Design, for their guidance and expertise on this subject. Gerald F. Loberger Jr., also of Computerized Structural Design, to whom I am indebted for all of the enclosed CAD drawings.

## TABLE OF CONTENTS

List of Figures .....	vii
List of Tables .....	x
Chapter 1: Introduction .....	1
1.1: Background .....	1
1.2: Problem Statement .....	5
1.3: Objectives & Scope of Investigation .....	8
1.4: Literature Review .....	9
1.5: General Purlin Behavior .....	14
Chapter 2: Computer Modeling .....	18
2.1: Finite Element Model .....	19
2.2: Parametric Study .....	25
2.3: Results of Computer Modeling .....	27
2.4: Elastic Buckling Corrections .....	38
Chapter 3: Experimental Program .....	40

3.1: Introduction .....	40
3.2: Test Specimens .....	40
3.3: Test Assembly .....	42
3.3.1: Axial Tests .....	42
3.3.2: Flexural Tests .....	47
3.4: Test Procedure .....	50
3.4.1: Axial Tests .....	50
3.4.2: Flexural Tests .....	50
3.5: Test Results .....	51
3.6: Test Evaluation .....	55
Chapter 4: Results, Discussion, and Comparison of Computer Modeling w/Experimental Program .....	57
Chapter 5: Conclusions and Recommendations .....	61
Bibliography .....	66
APPENDIX 1: Test Matrix .....	67
APPENDIX 2: Finite Element Model Test Results .....	111

APPENDIX 3: Corrected Finite Element Model Test Results .....	133
APPENDIX 4: Sample Calculation for Finite Element Model Results .....	155
APPENDIX 5: Data Sheets for Experimental Tests .....	160
APPENDIX 6: Sample Calculations for Axial Load Correction .....	176
APPENDIX 7: Proposed Design Approach and Example .....	179



## LIST OF FIGURES

Figure 1: Profile of Through-Fastened Roof Panel .....	1
Figure 2: Profile of Standing Seam Roof Panel .....	1
Figure 3: Types of Standing Seam Panel Configurations .....	2
Figure 4: Attachment of Panel to Purlin .....	3
Figure 5: Unseamed Cross-Section of Standing Seam Roof .....	4
Figure 6: Sliding Clip .....	5
Figure 7: Fixed Clip .....	5
Figure 8: Composition of a Metal Building .....	7
Figure 9: Actual Panel/Clip/Purlin Assembly vs. Equivalent Model .....	8
Figure 10: Geometric and Principal Axes of a Z-purlin .....	15
Figure 11: Purlin Midspan Deflection without Presence of Panel .....	16
Figure 12: Midspan Deflection of Purlin Attached to Panel Subject to Uplift Load and Axial Load .....	17
Figure 13: Finite Element Model .....	18
Figure 14: F.E.M. Boundary Conditions at Supported End (Side View) .....	19
Figure 15: F.E.M. Boundary Conditions at Loaded End (Side View) .....	19
Figure 16: Boundary Conditions for Diaphragm (Plan View) .....	20
Figure 17: Schematic of SBHQ6 Finite Element .....	21
Figure 18: Effect of Finite Element Aspect Ratios on Model Results .....	22
Figure 19: Cross-Section of Purlin Model .....	23
Figure 20: Local Coordinate Axes .....	24

Figure 21: Application of Axial Load .....	25
Figure 22: Application of Uplift Load .....	25
Figure 23: Axial/Flexural Buckling Strength vs. Flange Width .....	29
Figure 24: Axial/Flexural Buckling Strength vs. Purlin Thickness .....	30
Figure 25: Axial/Flexural Buckling Strength vs. Diaphragm Stiffness .....	31
Figure 26: Axial/Flexural Buckling Strength vs. Diaphragm Rotational Stiffness .....	32
Figure 27: Axial/Flexural Buckling Strength vs. Purlin Depth .....	33
Figure 28: Axial/Flexural Buckling Strength vs. Purlin Length .....	34
Figure 29: Axial/Flexural Buckling Strength vs. Out-of-Straightness .....	35
Figure 30: Axial/Flexural Buckling Strength vs. $\frac{b}{t}$ .....	36
Figure 31: Axial/Flexural Buckling Strength vs. $\frac{d}{t}$ .....	37
Figure 32: Plan View of Axial Test Setup .....	44
Figure 33: End View of Axial Test Setup .....	45
Figure 34: Section Through End View of Test Setup .....	45
Figure 35: Seamed Cross-Section of Standing Seam Roof Panel .....	46
Figure 36: Flexural Test Setup .....	49
Figure 37: Use of Anti-Roll Clips .....	49
Figure 38: Experimental vs. Analytical $k_{af}$ Values .....	59
Figure 39: Proposed Solution .....	63
Figure 40: Proposed Solution (Data points removed above $\frac{d}{t}$ of 170) .....	64
Figure 41: Location of Dial Gages .....	174

Figure 42: Location of Strain Gages ..... 175

## LIST OF TABLES

Table 1: Results of Axial Tests .....	51
Table 2: Results of Flexural Tests .....	52
Table 3: Tension Test Results .....	53
Table 4: Dimensions of Failed Members .....	54
Table 5: Experimental Values of $k_{af}$ .....	56
Table 6: Comparison of Experimental and F.E.M. Axial Tests .....	60
Table 7: Comparison of Experimental and F.E.M. Flexural Tests .....	60
Table 8: Predicted Axial Load from Flexural Test Results .....	65
Table 9: Predicted vs. Experimental Axial Test Results .....	65

## CHAPTER 1: INTRODUCTION

### 1.1 BACKGROUND

Purlins are secondary structural members commonly used in the metal building industry for roof framing. These secondary structural members are used to transfer gravity and wind loads from the roof panel to the rafter beams. The most common purlin shapes are C- and Z-sections. When longer spans do not lend themselves to using C- or Z-sections, steel joists may be used. In this paper, all references to purlins are to Z-purlins supporting a standing seam roof system attached to one flange of the purlin.

In roof construction, purlins support either a through-fastened roof panel (see Figure 1) or a standing seam roof system (see Figure 2). Standing seam roof systems



Figure 1: Profile of Through-Fastened Roof Panel

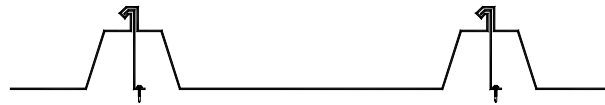

Figure 2: Profile of Standing Seam Roof Panel

come in a variety of panel configurations (see Figure 3), and are suited for a wide range of applications.

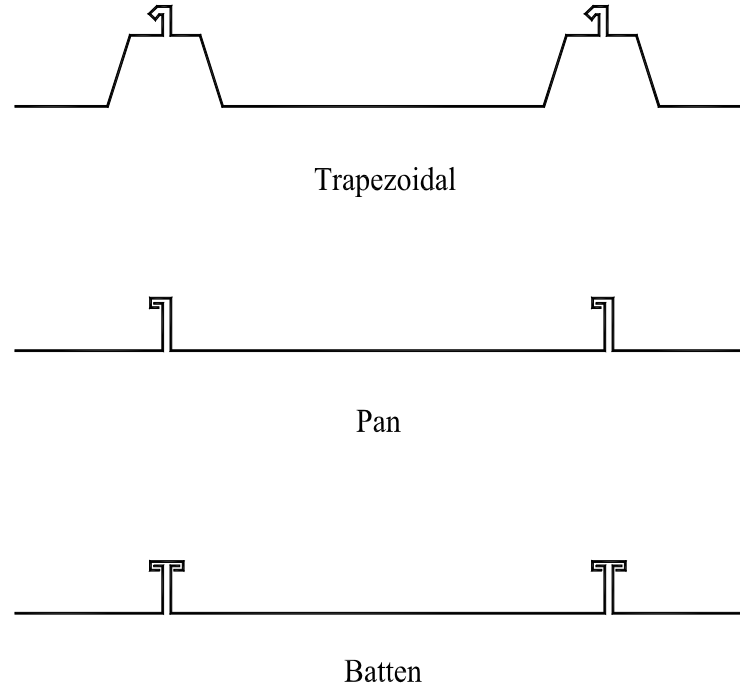

Figure 3: Types of Standing Seam Panel Configurations

Two main advantages of a standing seam roofing system when compared to a through-fastened panel are:

- i. The standing seam roof system provides a better seal against the environment.
- ii. Thermal movements are not restrained.

In a standing seam roof system, all of the structural fasteners are concealed under the roof panel (with the exception of panel end laps) and thus the fasteners are not directly exposed to the exterior of the building.

The standing seam roof panel is not attached to the purlin flange directly, it is connected to the purlin flange via panel clips (see Figure 4). Panels are placed sequentially starting at the eave of the building. The high ribs on the standing seam roof

panel consist of a male and female rib (see Figure 5). The male rib on the panel is the rib to which the panel clips are attached. The female rib is the rib on the opposite edge of the

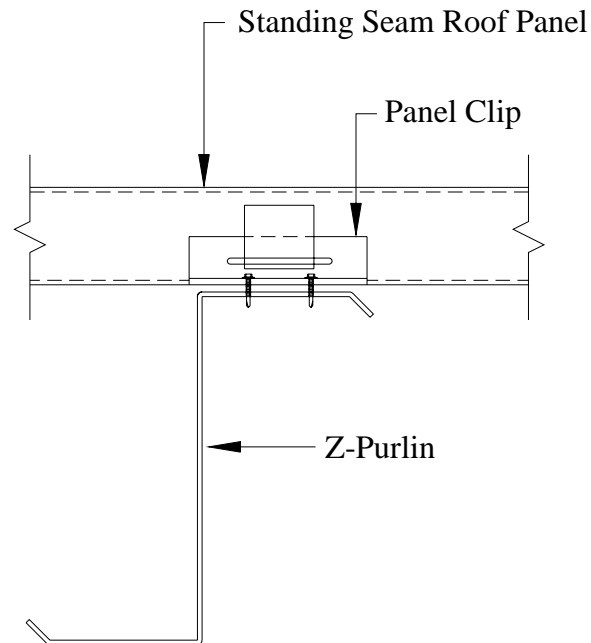

Figure 4: Attachment of Panel to Purlin

panel. After the panel clips have been attached to the male rib, the female rib is placed over the male rib. Once the two ribs are in place, with the clip tab positioned between the male and female panel plies, the standing seam is sealed. It is the sealing process that gives the roof the environmental barrier.

The sealing process is accomplished in different ways depending on the type of panel profile in question. Some panel profiles require a mechanical seamer in the sealing operation. In these cases, the male and female ribs are actually rolled together and the resulting seam is tightly interlocked. This typically occurs with the trapezoidal panel profiles (see Figure 3). Pan type panel profiles (see Figure 3) generally will require a

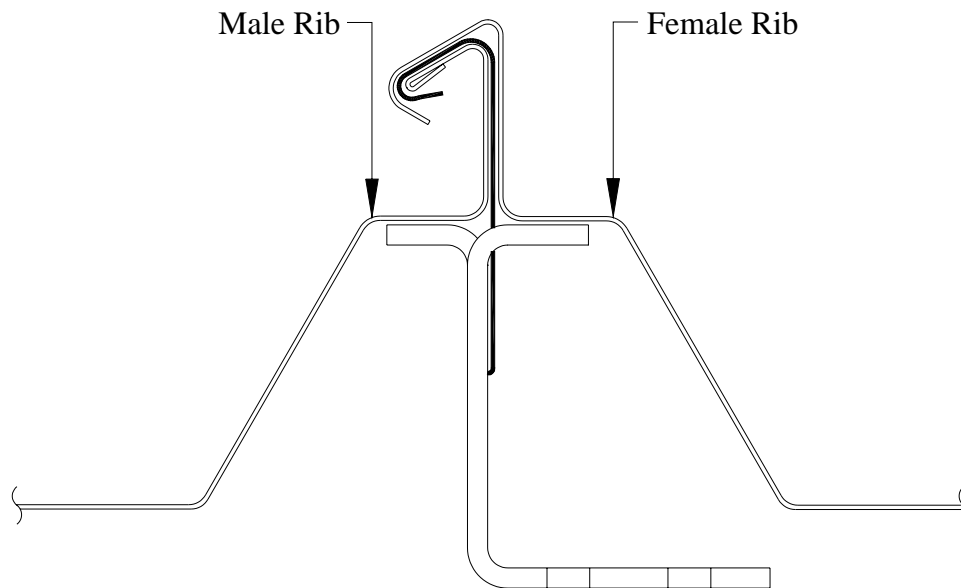

Figure 5: Unseamed Cross-Section of Standing Seam Roof

mechanical device to crimp the seam. In this type of profile, the seam is not rolled as tightly as is the trapezoidal panel profile. A third type of panel profile is a batten type panel (see Figure 3). This panel profile does not require a mechanical seaming device to produce the final seamed product. In this case either a batten strip, as is shown in Figure 3 can be used, or the male and female ribs of the panel can literally snap together.

To attach a through-fastened panel to the purlin, screws are installed through the roof panel and are directly exposed to the building exterior. While these fasteners are installed using neoprene washers, this generally does not eliminate the potential for a leak.



The relief of thermal expansion and contraction is an important consideration in design. Thermal movements, if not properly relieved, can severely damage a roof system. With through-fastened roof systems, fastening directly into the purlin flange results in a system that does not properly relieve thermal movements. The standing seam roof system accommodates thermal movements, in many cases, by incorporating sliding clips (see Figure 6). However, some standing seam roof systems have fixed clips (see Figure 7). While the fixed clip does not provide the same degree of flexibility with regard to lateral movement as does the sliding clip, some lateral movement can be provided by the tab of the clip sliding within the seam (between the male and female plies) of the panel.

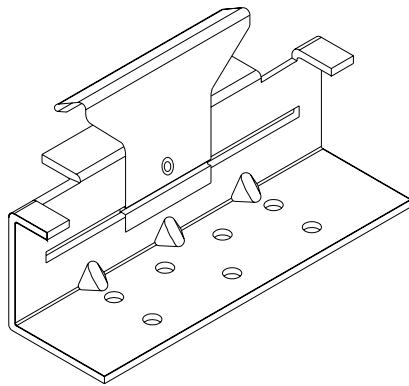

Figure 6: Sliding Clip

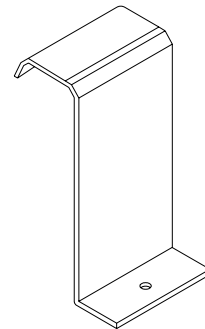

Figure 7: Fixed Clip

## 1.2 PROBLEM STATEMENT

In building frames, when subject to wind loads, some purlins, referred to as strut-purlins, must resist axial forces as well as bending. Strut-purlins are located over or adjacent to the end wall columns in a building and run through the bay(s) which include wind bracing (see Figure 8). As the wind load is applied to the end wall of a building, the

resulting lateral force is transferred from the wall panel to the girt system and to the end wall columns. Once the lateral load is in the end wall columns, a portion of this load is transmitted to the base of the column and a portion is transmitted to the roof. At the roof location, the end wall column transfers the lateral load into the purlin which is then passed, “strutted”, along the purlin line until the force reaches the bay in which the roof bracing is located. At this point the roof bracing transmits the lateral force out to the sidewalls of the building, into the sidewall bracing and down to the foundation system.

To design strut-purlins, the axial and flexural uplift load capacity of the purlin and panel system being used must be known. When strut-purlins are subject to axial and flexural uplift loads their bottom flanges are in compression and may not be braced by conventional bracing methods (i.e. X-braced sag angles, etc.). The lateral bracing that is provided to the bottom flange occurs through the torsional resistance of the purlin to panel connection (see Figure 9). Currently, the accepted procedure for determining the axial load capacity of purlins attached to a standing seam roof consists of conducting full-scale axial load tests. The axial load test procedure is outlined in Appendix II of the American Iron and Steel Institute (AISI) Design Guide CF97-1, “A Guide for Designing with Standing Seam Roof Panels”<sup>4</sup>. To determine the flexural uplift capacity of a purlin/panel system without discreet bracing, uplift base tests, as described in the AISI Cold-Formed Steel Design Manual<sup>10</sup>, must be conducted.

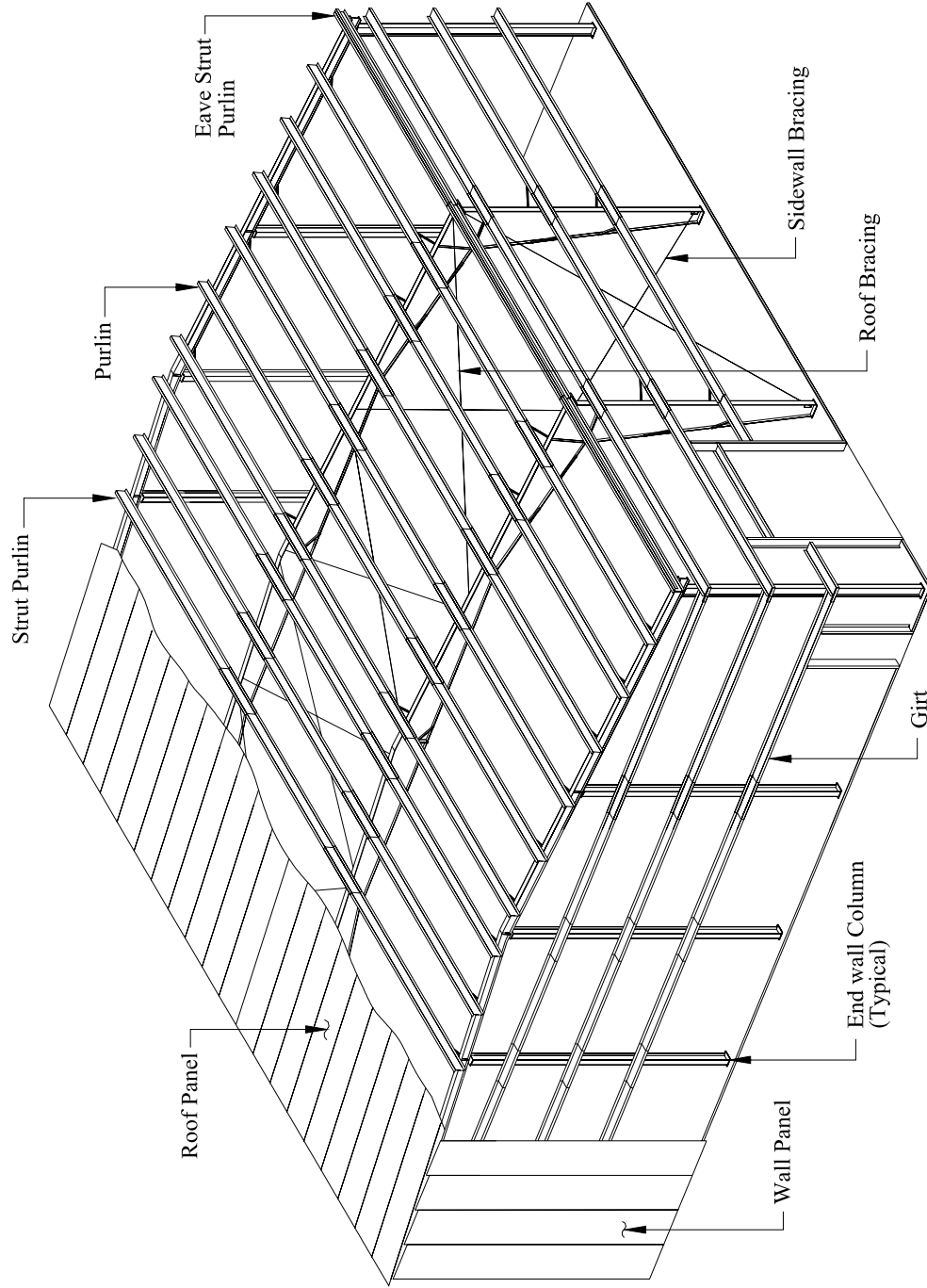

Figure 8: Composition of a Metal Building (Figure courtesy of Varco Pruden Buildings)

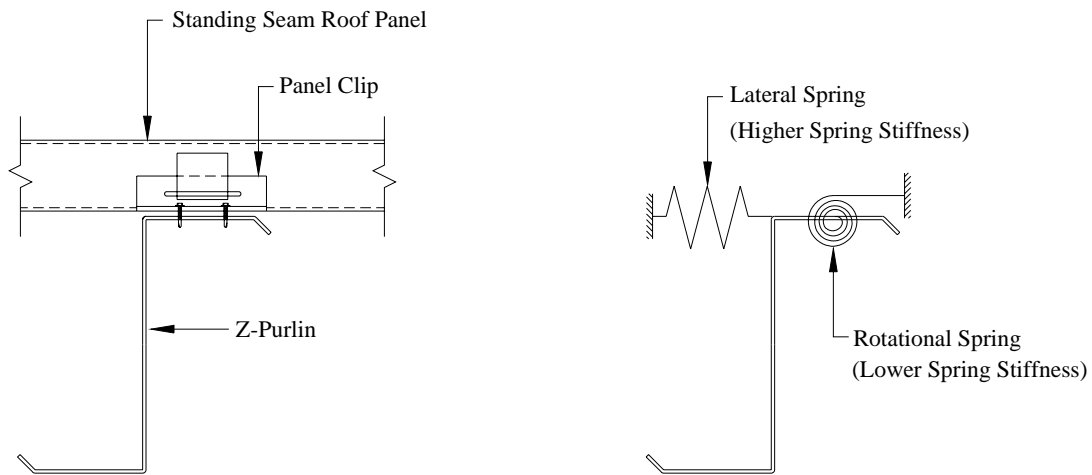

Figure 9: Actual Panel/Clip/Purlin Assembly vs. Equivalent Model

### 1.3 OBJECTIVES & SCOPE OF INVESTIGATION

As mentioned, due to the lack of an analytical solution, designers of metal buildings are required by code to conduct Uplift Base Tests to determine the flexural capacity of their standing seam roof systems in the absence of discrete bracing. It is hypothesized that the axial strength of Z-purlins can be obtained by applying a factor or factors to the results of flexural uplift base tests. The objective of this research is to validate this hypothesis and to determine this factor or factors.

To validate this hypothesis, a relationship between the axial buckling strength and the flexural uplift buckling strength in the Z-purlin must be developed. The relationship has been established using finite elements to model different aspects of the purlin geometry (i.e. purlin depth, thickness, flange width, etc.) and panel characteristics. At the conclusion of this research, a series of full-scale tests are conducted to confirm this relationship.

## 1.4 LITERATURE REVIEW

To date, there has been limited research in the area of determining the axial strength of purlins attached to standing seam roof panels.

Simaan and Pekoz researched the axial capacity of diaphragm braced C- and Z-sections and their application to wall studs<sup>1,7</sup>. Simaan predicted the axial capacity of light gage C- and Z-sections, with flanges braced by diaphragms on one and both sides, using an energy method approach. The analytical results were then verified experimentally. Equation 52, from Simaan's thesis, predicts the critical buckling load for a Z-section braced on one side with hinged ends. For a given section with known Q and F values, the lowest root of the cubic equation results in the critical buckling load. Due to the complexity of this design equation, computer programs were developed and are presented in Simaan's thesis<sup>1</sup>.

$$\begin{aligned}
 & P^3 - P^2 \left[ P_x + P_y + Q + P_\phi + \frac{1}{r_o^2} \left( Q \frac{d^2}{4} + \frac{F L^2}{n^2 \pi^2} \right) \right] \\
 & + P \left\{ (P_y + Q) P_x - P_{xy}^2 + (P_y + Q + P_y) \left[ P_\phi + \frac{1}{r_o^2} \left( Q \frac{d^2}{4} + \frac{F L^2}{n^2 \pi^2} \right) \right] - \frac{1}{r_o^2} \left( Q \frac{d}{2} \right)^2 \right\} \quad Eq.52 \\
 & - \left[ (P_y + Q) P_x - P_{xy}^2 \right] \left[ P_\phi + \frac{1}{r_o^2} \left( Q \frac{d^2}{4} + \frac{F L^2}{n^2 \pi^2} \right) \right] + \frac{1}{r_o^2} P_x \left( Q \frac{d}{2} \right)^2 = 0
 \end{aligned}$$

Where:

$P_x$  = Euler buckling load about the x-axis

$P_y$  = Euler buckling load about the y-axis

$P$  = Buckling load

$Q$  = Shear rigidity of the diaphragm bracing

$P_\phi$  = Torsional buckling load

$$r_o^2 = I_p/A$$

$I_p$  = Polar moment of inertia about the shear center

$A$  = Cross-sectional area

$d$  = Overall dimension of web (depth of section)

$F$  = Rotational restraint by diaphragm bracing

$n$  = Number of half-sine waves into which the column may buckle, or the  $n$ th term of the series

$L$  = Length of the column

Similar work has been conducted by Hatch in regards to strength evaluation of strut-purlins through-fastened to roof panels<sup>2</sup>. The basis of this research was to verify that strut-purlin strength could be predicted by using the interaction equation listed in the AISI Specification. In the research, Hatch calculated the flexural uplift strength of the purlins using the AISI Specification and the axial load strength of the purlins using the computer programs developed by Simaan and Pekoz<sup>1</sup>. Through confirmatory testing, Hatch concluded that the programs developed by Simaan and Pekoz were general enough to be applied to strut-purlins in metal building roof systems.

The design criteria listed in Chapter C4.4 of the AISI Specification for the Design of Cold-Formed Steel Structural Members<sup>3</sup> was developed for strut-purlins through-fastened to roof panel. Equation C4.4-1 predicts the nominal axial load capacity about the weak axis of compression members.

$$P_n = \frac{C_1 C_2 C_3 A E}{29500} \quad (\text{Eq. C4.4-1})$$

where

$$C_1 = (0.79x + 0.54) \quad (\text{Eq. C4.4-2})$$

$$C_2 = (1.17t + 0.93) \quad (\text{Eq. C4.4-3})$$

$$C_3 = (2.5b - 1.63d + 22.8) \quad (\text{Eq. C4.4-5})$$

For Z-sections,  $x$  = the fastener distance measured from the outside web edge divided by the flange width. This is a measure of the location of the fastener within the flange width.

$t$  = Section thickness in inches

$b$  = Flange width in inches

$d$  = Section depth in inches

$A$  = The gross, unreduced, area of the section

$E$  = Modulus of Elasticity of steel

Reviewing the constants reveals that the value of constant  $C_1$  is influenced by the placement of the fasteners within the purlin flange, the constant  $C_2$  is influenced by the thickness of the purlin section and the constant  $C_3$  is determined from the combined effects of flange width and purlin depth. Restrictions imposed on the use of the equations are as follows:

1. Sections not exceeding 0.125-inches in thickness
2. 6-inches  $\leq d \leq$  12-inches
3. Flanges were to be edge stiffened compression elements
4.  $70 \leq \frac{d}{t} \leq 170$

5.  $2.8 \leq \frac{d}{b} < 5$
6.  $16 \leq \frac{\text{flange flat width}}{t} < 50$
7. Both flanges are prevented from moving laterally at the supports
8. Steel roof or steel wall panels with fasteners spaced at 12 inches on center or less and having a minimum rotational stiffness of 0.0015 k/in/in (fastener at mid-flange width) as determined by the AISI test procedure
9. C- and Z-Sections having a minimum yield point of 33 ksi
10. Span length not exceeding 33 feet

The basis for the design criteria listed in Chapter C4.4 of the AISI Cold-Formed Specification<sup>3</sup> was the research conducted by Glaser, Kaehler and Fisher<sup>5</sup>. The primary objective of this research was to develop a simplified design equation that would predict the axial load capacity of C- and Z-sections with one flange through-fastened to roof panel. In their research, a parametric study was conducted using parameters required in the Simaan equations. The parameters used in the Simaan equations were:

1. Member Length
2. Section Depth
3. Flange Width
4. Member Thickness
5. Rotational Stiffness of the Deck to Flange Connection, 'F' factor
6. Form Factor (Q)
7. Allowable Diaphragm Strain



8. Diaphragm Shear Rigidity
9. Allowable Purlin Rotation
10. Yield Strength
11. Fastener Spacing

The parametric study indicated that section depth, flange width, member thickness and the rotational stiffness of the deck to flange connection could not be eliminated in the formulation of the design equation, Eq. C4.4-1. It was determined that the remaining parameters could be ignored provided certain practical limitations were imposed.

In the research conducted by Glaser, Kaehler and Fisher, length was determined not to be an important parameter. This was due to the short wave lengths of the buckling modes experienced during failure. For short to intermediate length purlins, the buckling behavior was similar to that of a plate subject to an axial load. At failure, the plate would buckle into one or more sinusoidal waves. It was noted that at longer purlin lengths strong axis buckling would control.

Though not the main objective of the Glaser research, axial load tests were conducted with standing seam roof substituted for the through-fastened roof panel. Based on the test results, it was concluded that an equation similar to AISI Spec. Eq. C4.4-1 could not be developed for strut-purlins with one flange attached to standing seam roof panel. This was due to the fact that the strut-purlin strength is dependent on the strength and stiffness of the diaphragm<sup>5</sup>. Depending on the type of standing seam roof panel used, the diaphragm strength and stiffness can vary quite dramatically.

The rotational stiffness provided by the attachment of the panel and clip to the top flange of the purlin, also referred to as the 'F' factor, plays a significant role in the determination of the axial and flexural uplift load capacity. Research conducted by LaBoube<sup>6</sup>, on through-fastened roof panel, illustrates what factors influence the rotational stiffness of the panel and clip to purlin flange assembly. LaBoube concluded that the rotational stiffness, or 'F' factor, was primarily dependent upon the purlin thickness, roof panel thickness and fastener type and location within the width of the purlin flange.

### 1.5 GENERAL PURLIN BEHAVIOR

When Z-purlins supporting a standing seam roof system are loaded in flexure, as is the case when subject to uplift due to wind loads and under gravity loads, they have a tendency to translate horizontally and roll about their longitudinal axis. This is due, in part, to the fact that the principal axes of the purlin do not coincide with the geometric axes (see Figure 10). When vertical loads are applied about the geometric axis, the purlin wants to orient itself such that bending occurs about its major principal axis. It can be seen, in Figure 10, that the vertical load acts at an angle to the principal axes (denoted as  $x'$  and  $y'$  in Figure 10) thus inducing unsymmetrical bending in the section. Breaking the vertical load up into its components perpendicular to the major and minor principal axes results in a component that produces lateral translation. Without the presence of top flange bracing, the Z-purlin, at mid-span, deflects in a vertical and horizontal direction and rotates as shown in Figure 11. When top flange bracing is added, via the standing seam roof panel, the top flange is supported laterally by a horizontal spring (see Figure 9). With the addition of the horizontal spring, a large portion of the lateral displacement

of the top flange is restrained. With the top flange partially restrained and the purlin wanting to deflect laterally, the bottom flange, which is largely unsupported, has a tendency to “kick out” as is shown in Figure 12.

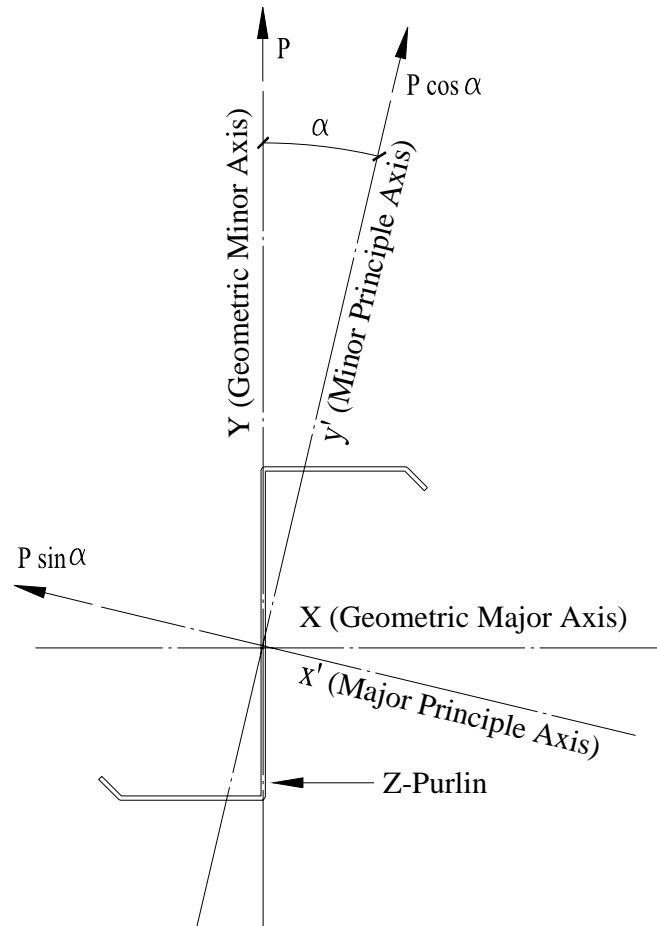

Figure 10: Geometric and Principal Axes of a Z-purlin

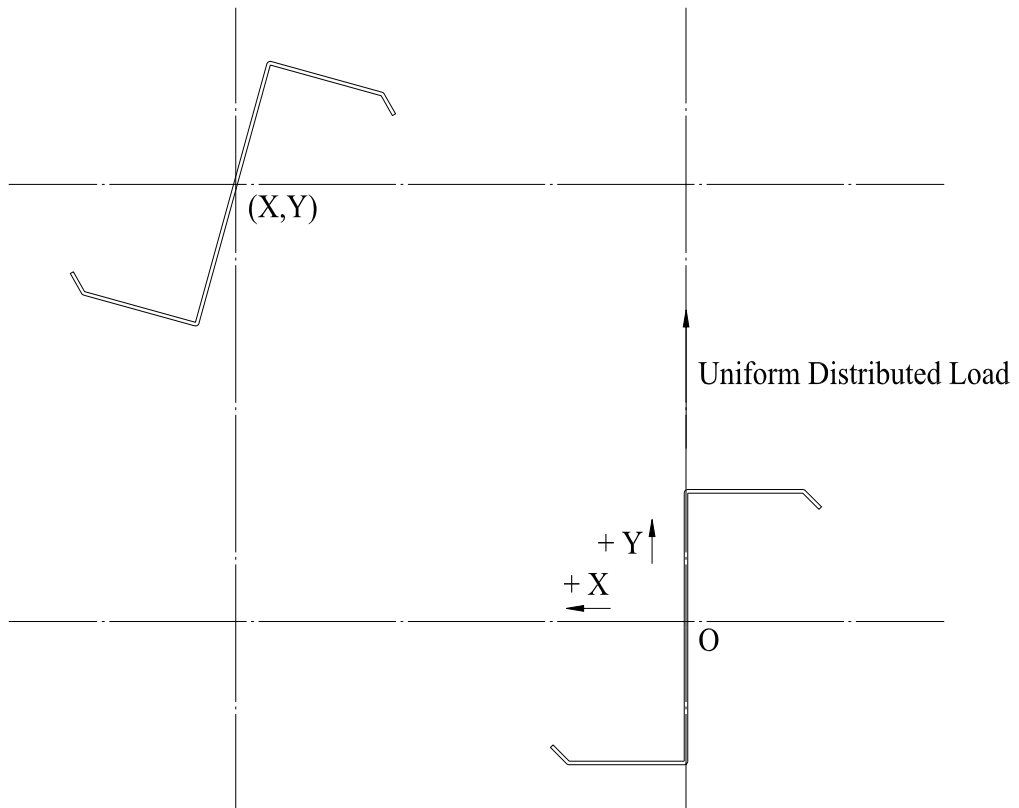

Figure 11: Purlin Midspan Deflection without Presence of Panel

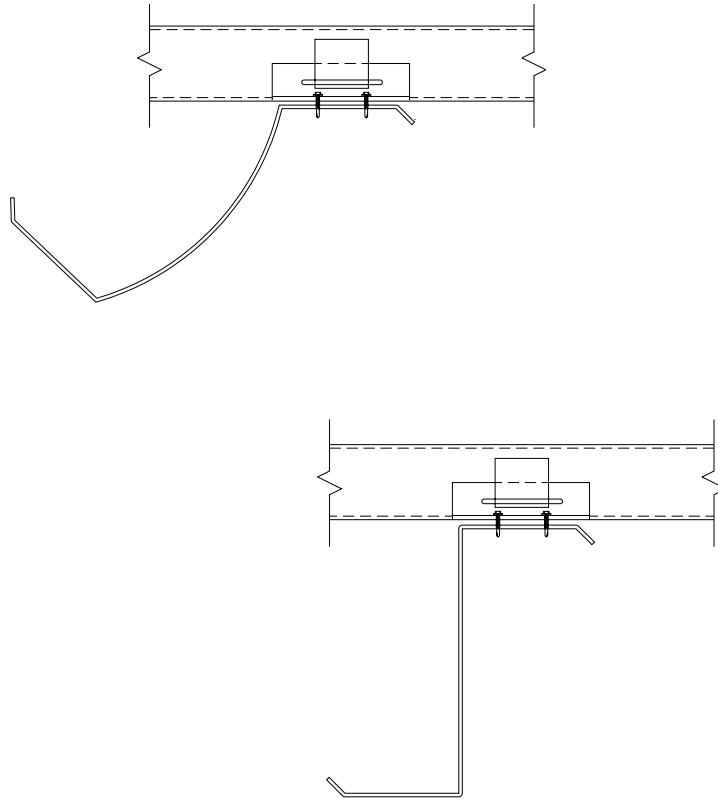

Figure 12: Midspan Deflection of Purlin Attached to Panel Subject to Uplift  
Load and Axial Load

## CHAPTER 2: COMPUTER MODELING

To accomplish the objectives of this research, an analysis program with finite element capabilities was required. The software that was chosen to conduct the finite element studies was GTSTRUDL<sup>9</sup>. GTSTRUDL is an analysis/design software that offers finite element capabilities including linear elastic buckling analyses. An isometric view of the purlin/panel model is shown in Figure 13. Shown in Figures 14 and 15 are the boundary conditions associated with the supported and loaded ends of the finite element model, respectively. Figure 16 shows the boundary conditions associated with the roof diaphragm.

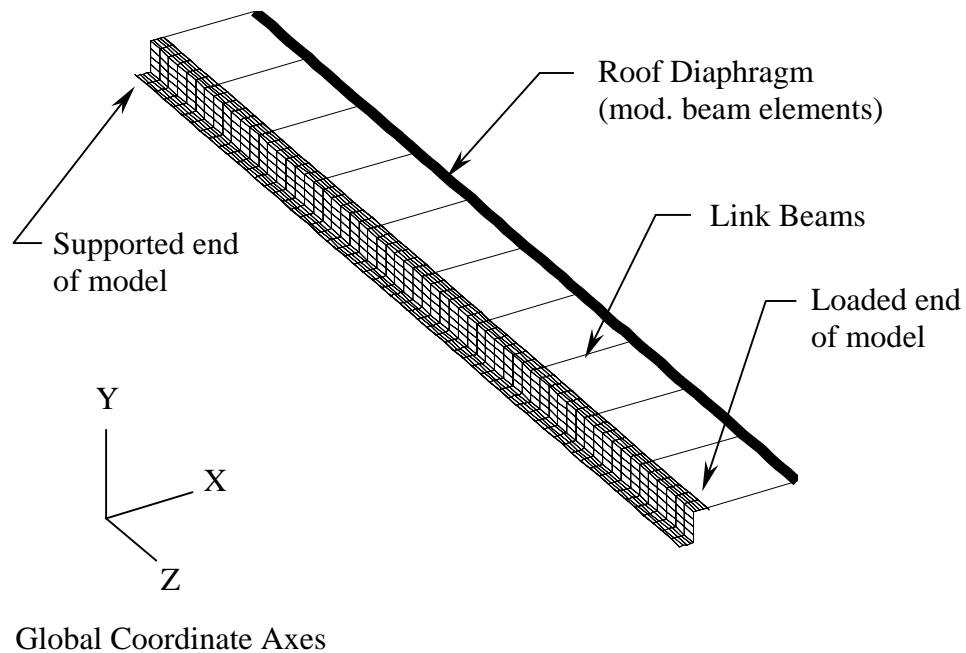

Figure 13: Finite Element Model

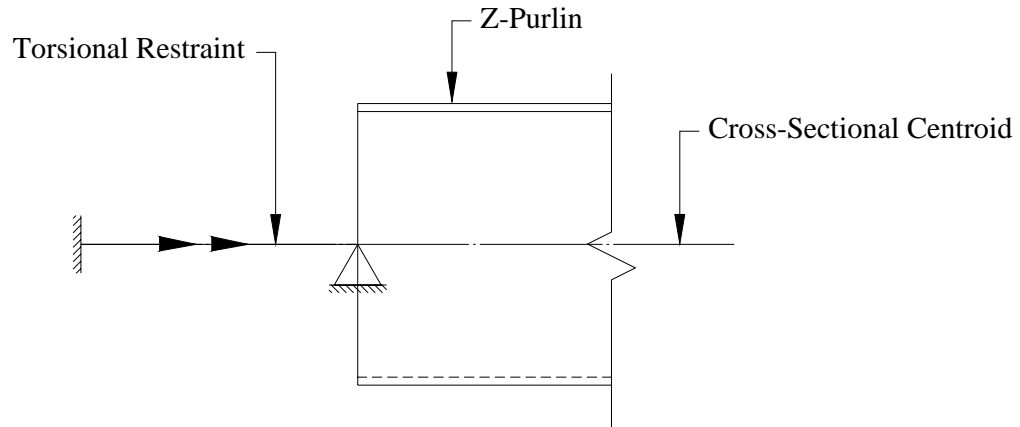

Figure 14: F.E.M. Boundary Conditions at Supported End (Side View)

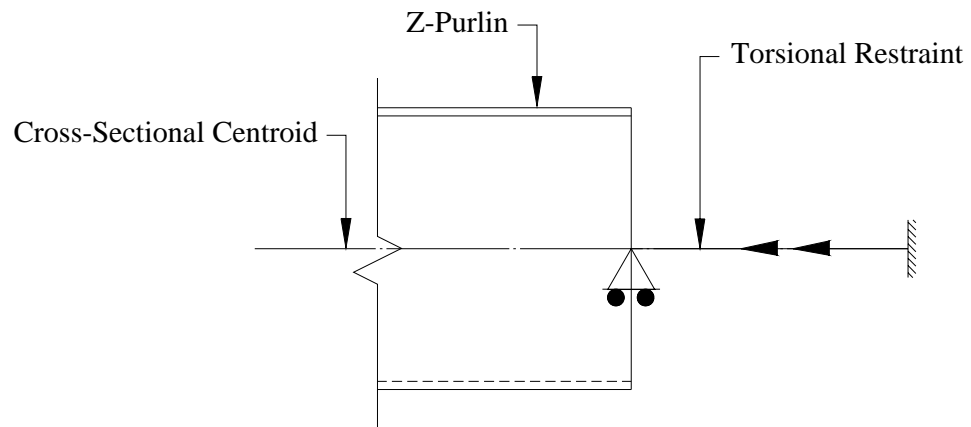

Figure 15: F.E.M. Boundary Conditions at Loaded End (Side View)

## 2.1 FINITE ELEMENT MODEL (FEM)

### Finite Element Selection:

Z-purlins are thin-walled members, therefore, plate elements were recommended for modeling this type of section. The GTSTRUDL plate element used for this

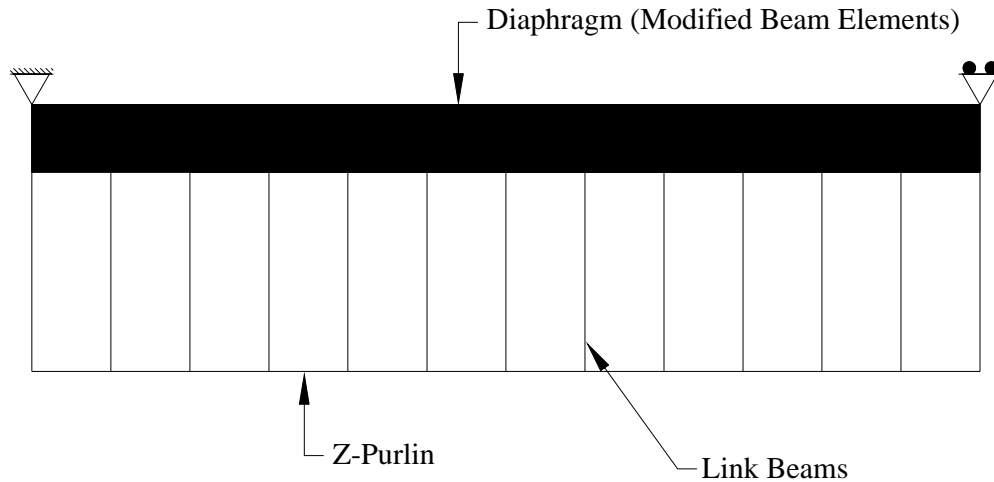

Figure 16: Boundary Conditions for Diaphragm (Plan View)

application was the Stretching and Bending Hybrid Quadrilateral element with Six Degrees of Freedom (SBHQ6, Table 2.3.1 of Vol. 3 of the GTSTRUDL User Manual<sup>9</sup>) per node (see Figure 17). The stiffness matrix for this element is formed by superimposing the Plane Stress Hybrid Quadrilateral element (PSHQ<sup>9</sup>), the Bending Plate Hybrid Quadrilateral element (BPHQ<sup>9</sup>), and a fictitious rotational stiffness for the rotation about an axis normal to the surface of the element. Discussion of the SBHQ6 element states that the fictitious rotational stiffness avoids the use of the planar coordinate system for joint coordinates for suppressing instabilities when analyzing shell problems.

For the PSHQ element, assumptions are made with respect to the stress field within the element and for the displacements on the boundaries. To determine the stresses within the element, quadratic displacement expansions are used and linear displacements are assumed on the boundaries of each element.



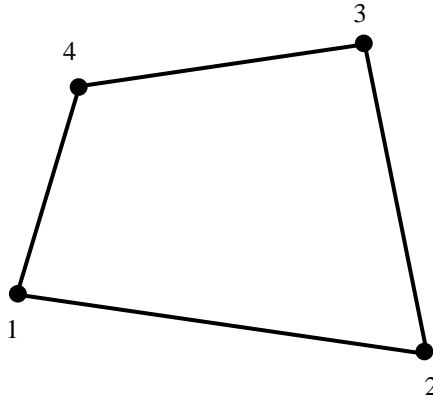

Figure 17: Schematic of SBHQ6 Finite Element

The BPHQ element uses a quadratic interpolation for the stresses within the element while a cubic displacement expansion is used for the transverse displacement along the boundaries. Linear normal rotations are assumed on the boundaries.

#### Aspect Ratios of Finite Elements:

To obtain accurate results from the finite element models, the aspect ratio of the finite element (the ratio of the longest dimension to the shortest dimension of the element) was limited to a maximum of 2:1. Figure 18 shows the results obtained from different finite element models by varying the aspect ratios of the finite elements. The graph shows the percent deviation from each model as the aspect ratio was increased. As can be seen, the larger the aspect ratio the more error that is introduced into the model results. As the aspect ratio gets smaller, the percent error in the results approaches zero. For the models used in the study, the aspect ratio of the elements making up the purlin

flange was 7/8:1 and the aspect ratio of the elements making up the web of the purlin was 2:1.

#### Boundary Conditions:

The purlins were supported at each end with a node located at the cross-sectional centroid (see Figure 19). At the supported end of the purlin, the rotations about the X and Y axes were released (see Figure 13 for coordinate axes). At the loaded end of the purlin, the displacement in the Z direction and the rotations about the X and Y axes were released.

Nodes at the center of the top flange of the purlin that intersected with link beams

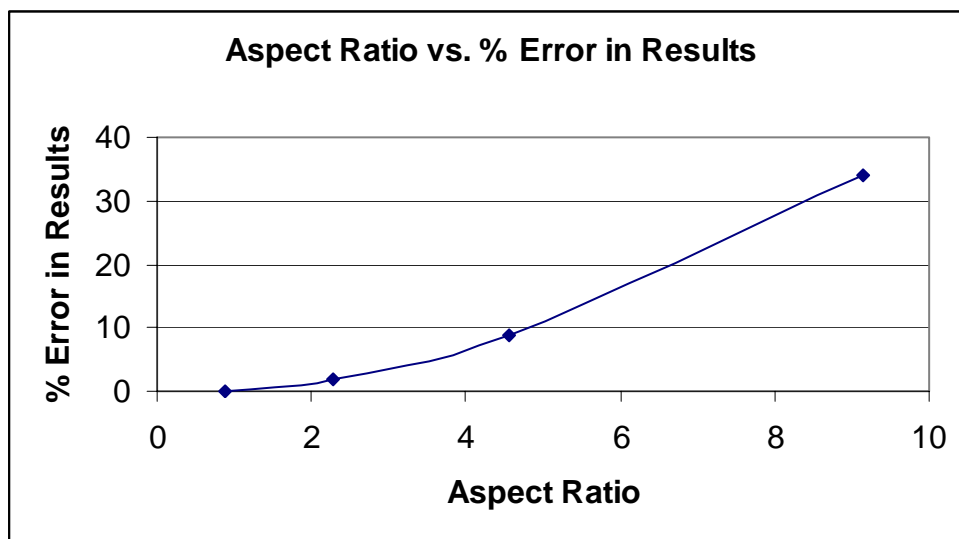

Figure 18: Effect of Finite Element Aspect Ratios on Model Results

were designated as supports. For these support nodes, all degrees of freedom were released with the exception of the Z-axis moment. The Z-axis moment at this location functions as the rotational stiffness of the purlin/clip/panel assembly. Therefore, the Z-

axis moment was input as an elastic rotational spring at each location where a link beam was located thus simulating the panel clip spacing.

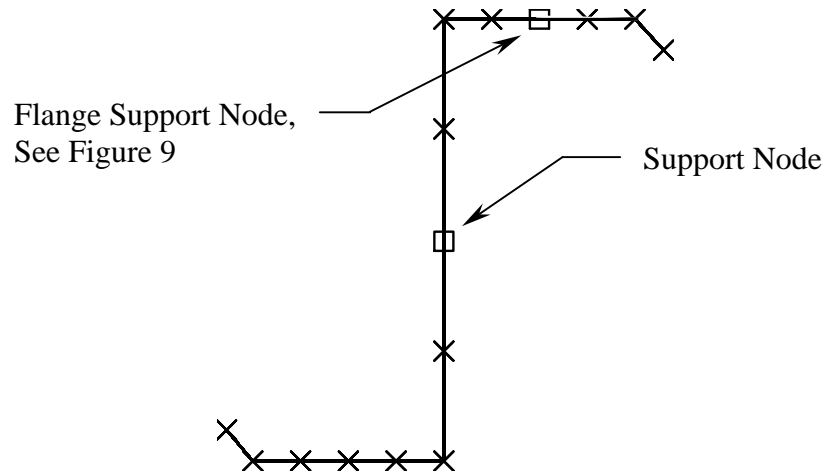

Figure 19: Cross-Section of Purlin Model

The diaphragm was modeled with simply supported ends (see Figure 16) with a series of modified beam elements. In reality, the diaphragm acts as a deep beam and thus shear deformations are more critical than the flexural deformations. Therefore, the beam elements were configured with a large moment of inertia about the local Y axis (see Figure 20) and the shear area,  $a_z$ , was changed to obtain the required diaphragm rigidity. The diaphragm has stiffness only in one direction, perpendicular to the span of the purlin. To simulate this stiffness characteristic of the diaphragm, the cross sectional area in the direction of the local x axis,  $a_x$ , and the shear area in the direction of the local y axis,  $a_y$ , were set close to zero.

The attachment of the roof diaphragm to the top flange of the purlin was accomplished through the use of link beams. The link beams were modified beam

elements that were connected to the center of the purlin flange at one end and to the diaphragm at the other end. All of the beam properties were set near zero with the exception of the cross-sectional area,  $a_x$ , along the length of the link beam. The only purpose of the link beams was to transfer axial load, induced from the lateral movement of the purlin flange, into the diaphragm.

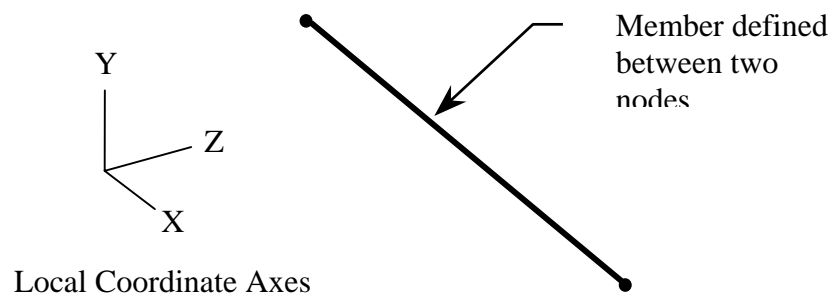

Figure 20: Local Coordinate Axes

#### Load Application:

The nodes along the supported end and the loaded end of the purlins were connected with beam elements. The beam elements were given large section properties so that they would provide sufficient stiffness to distribute the axial load to the purlin cross-section in a uniform manner. A point load of 1.0 kip was applied at the cross-sectional centroid of the purlin at the end (see Figure 21).

The total uplift load was applied along the center of the top flange of the purlin (see Figure 22). The magnitude of the total uplift load was 1.0 kip. This load was evenly divided by the number of nodes along the axis of the purlin (nodes were spaced at 1 inch).

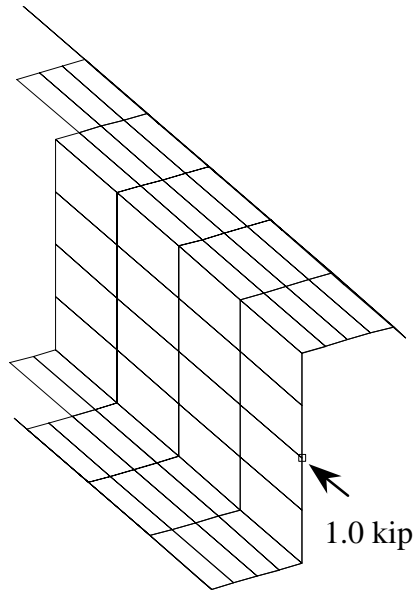

Figure 21: Application of Axial Load

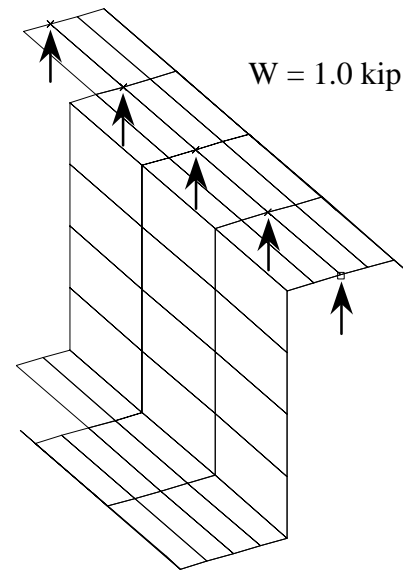

Figure 22: Application of Uplift Load

## 2.2 PARAMETRIC STUDY

Similar to the work conducted by Glaser, Kaehler and Fisher<sup>5</sup>, a study was conducted to determine what parameters had the most significant effect on the axial to flexural buckling strength ratio. Based on information contained in the American Iron and Steel Institute (AISI) Cold-Formed Steel Design Manual<sup>3</sup> and reports obtained from Hatch<sup>2</sup> and Glaser<sup>5</sup>, the following range of parameters were chosen as being applicable:

1. Purlin flange width:  
Range: 2-inches to 3.5-inches
2. Purlin thickness:  
Range: 0.061-inches to 0.120-inches

3. Diaphragm stiffness of SSR:  
Range: 0.6 K/in. to 2.4 K/in.
4. Rotational stiffness of the panel/clip to purlin flange assembly:  
Range: 1.2 K-in./rad. to 14.4 K-in./rad.
5. Purlin depth:  
Range: 8-inches to 12-inches
6. Purlin length:  
Range: 15-feet to 40-feet
7. Initial purlin out-of-straightness plus clip slip:  
Range: 0-inches to 2-inches

To establish an initial study, two values of each parameter were included (the high and low value as listed above). Applying practical limitations to this range of parameters resulted in purlin depths of 8-inches and 12-inches and purlin spans of 20-feet and 30-feet being used in the models.

In order to determine the ratio of the axial buckling strength to flexural uplift buckling strength, one finite element model was constructed for each case. Considering all of the different permutations, 256 finite element models were created initially. After the conclusion of the initial parametric study, two additional purlin thicknesses were added. Thus the parametric study, in its final state, consisted of 512 models (see APPENDIX 1 for the test matrix). It is noted that the appendices containing the test matrix and finite element test results indicate that 576 models exist. Due to the

elimination of models that fell outside of the practical limitations that were imposed, test numbers 5-8, 13-16, 21-24, 29-32, 37-40, 45-48, 53-56, 61-64, 69-72, 77-80, 85-88, 93-96, 101-104, 109-112, 117-120 and 125-128 were thrown out of the test matrix.

As an indication of how accurately the finite element models could predict the flexural uplift base tests, some of the available experimental data was used to create the models. Without knowing the exact panel strength and stiffness characteristics of the experimental data the finite element models predicted the failure loads to an accuracy of between 8 and 25 percent.

### 2.3 RESULTS OF COMPUTER MODELING

At completion of each of the finite element model analysis, the buckling load and a description of the buckled shape was recorded. After reviewing each result, the critical elastic buckling load was recorded into a spreadsheet that calculated the axial and flexural stress in the purlin based on gross sectional properties (see APPENDIX 4 for sample calculations). The results of the axial and flexural analyses were obtained in terms of elastic stresses due to the linear buckling analysis. As prescribed in Section 2.4, elastic buckling corrections were applied to the finite element results as required. Each of the purlin section properties was computed using Cold-Formed Steel Design Software<sup>8</sup> (CFS), Version 3.04.

Upon reviewing the flexural stresses resulting from the FEM analysis, it was noticed that in some cases the flexural stresses were higher than those obtained in the experimental tests. Reviewing the experimental test results revealed that the strength aspects of the standing seam roof system were not considered in the finite element

analysis. For example, in some cases the failure mode in the experimental tests was fracturing of the panel clips which attach the panel to the purlin. Based on these observations, in conjunction with calculated experimental flexural test results, the stresses obtained from the finite element models were truncated to a level that approximated the upper bound experimental test results. This maximum flexural stress level was chosen at 35 ksi. The maximum flexural stress obtained from the experimental test results was 38.7 ksi. Setting the cutoff flexural stress at 35 ksi results in a confidence interval of 88 percent (with a total of 25 experimental tests available to compare flexural results, 3 resulted in flexural stresses exceeding 35 ksi).

Similar to the flexural tests, the axial stress in each purlin obtained from the finite element models was truncated. The maximum axial stress obtained from the available experimental tests was 16.8 ksi. The cutoff axial stress was chosen at 18 ksi.

The next step was to compare each parameter with the ratio of the axial to flexural buckling strength (from this point referred to as  $k_{af}$ ). The anticipated benefit of using the axial to flexural buckling strength ratio is that parameters that would typically influence a purlin's capacity under either axial or flexural conditions would conceivably be cancelled out. Initial results show that the ratios of the elastic axial buckling strength to elastic flexural uplift buckling strength,  $k_{af}$ , range from approximately 0.16 through 0.51. Plots of  $k_{af}$  vs. each of the parameters, plus some parameter combinations, show considerable scatter in the data points obtained (see Figures 23 through 31). The lines between each data point show the trend that occurs between the low and high values of each combination of standing seam roof system. The best correlation was obtained with  $\frac{d}{t}$  (see Figure 31).



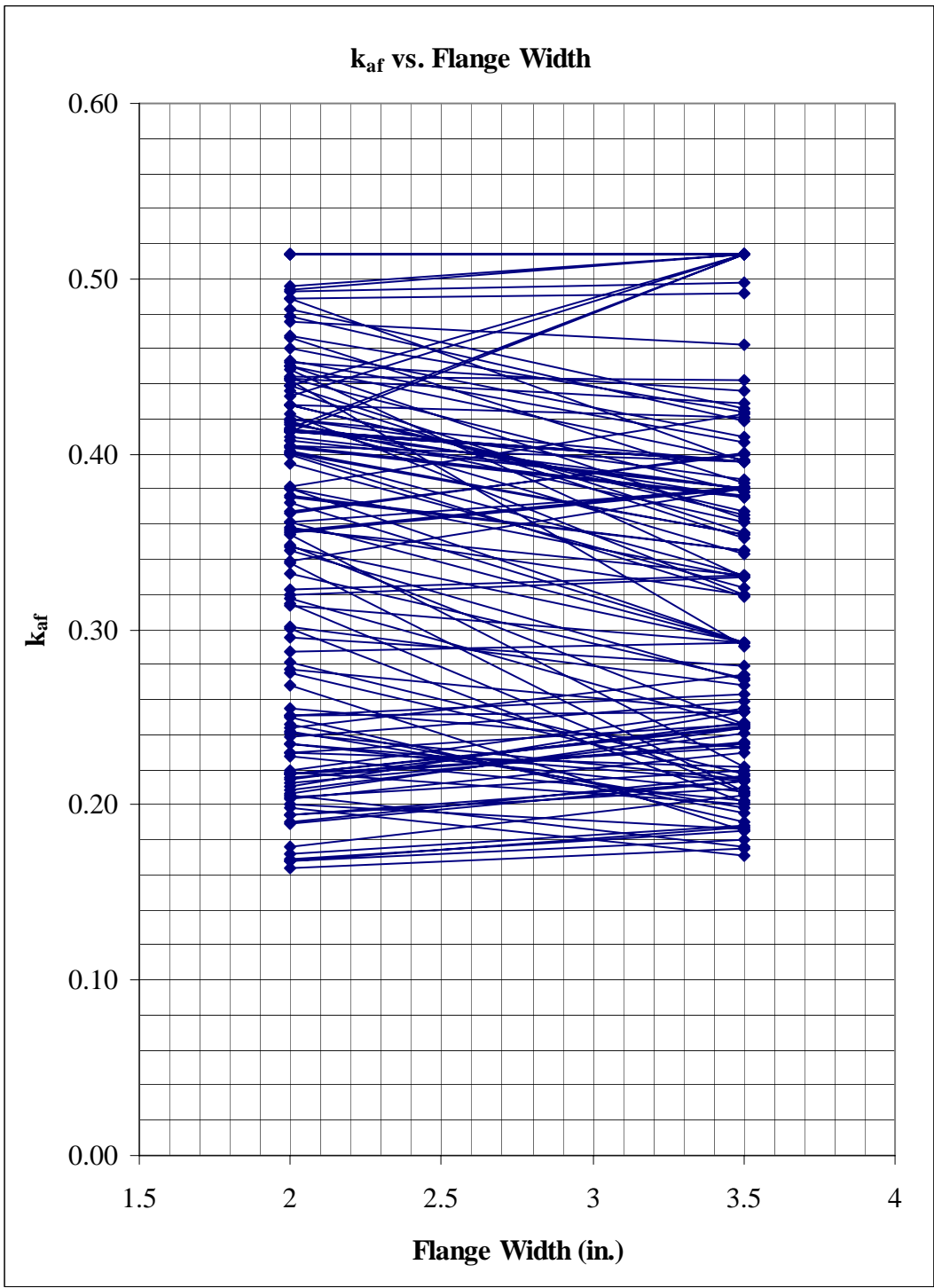

Figure 23: Axial/Flexural Buckling Strength vs. Flange Width

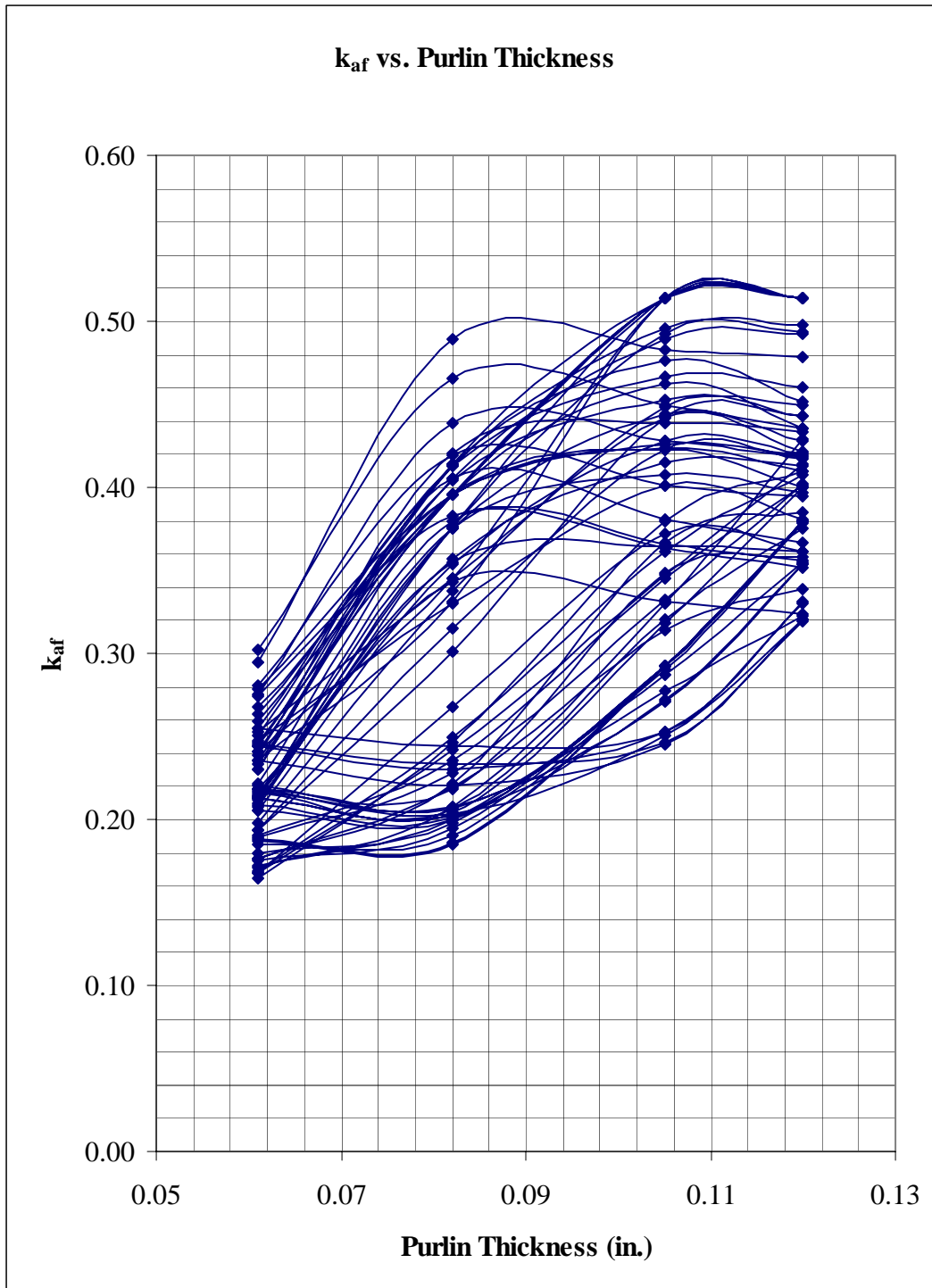

Figure 24: Axial/Flexural Buckling Strength vs. Purlin Thickness

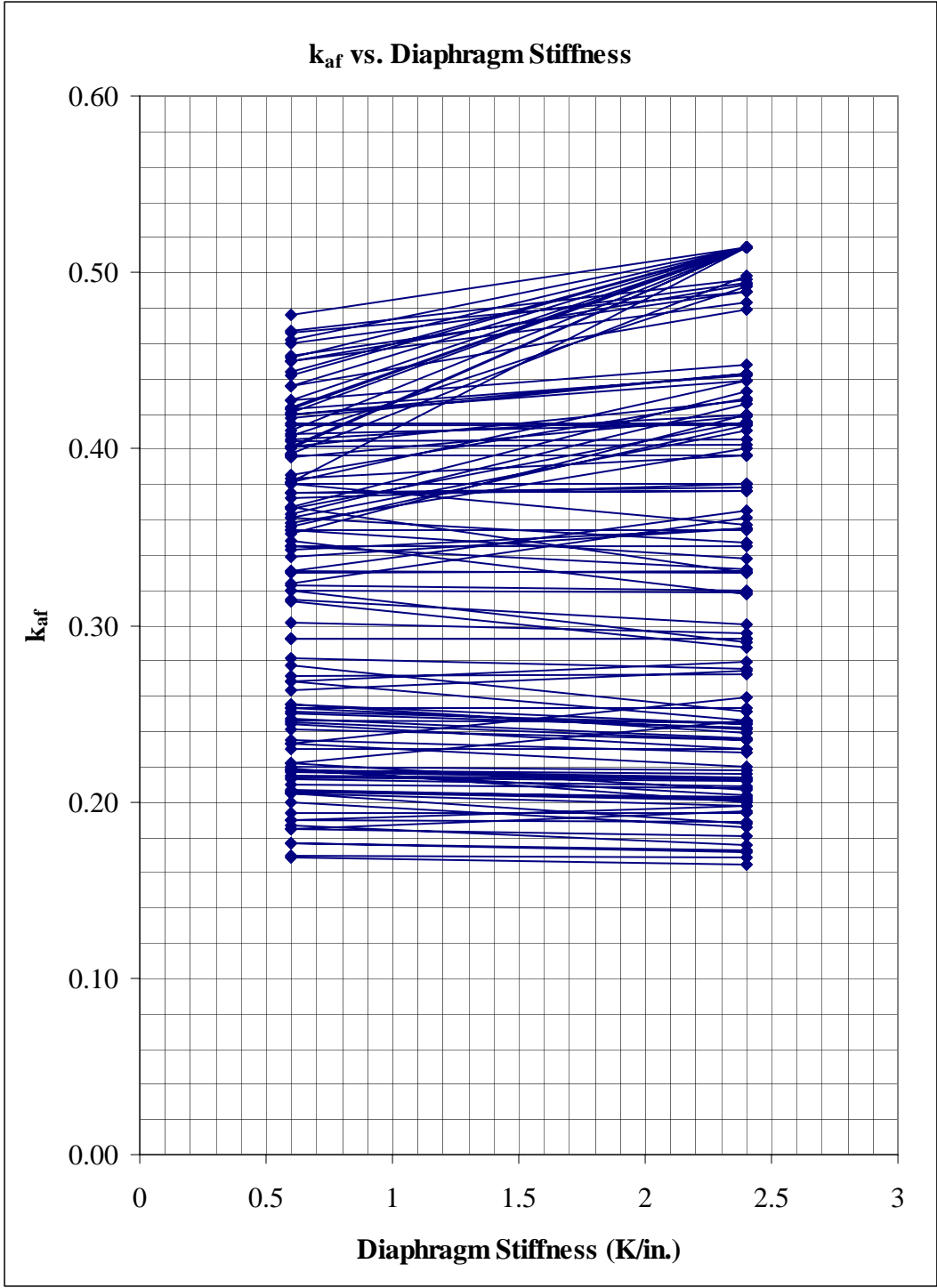

Figure 25: Axial/Flexural Buckling Strength vs. Diaphragm Stiffness

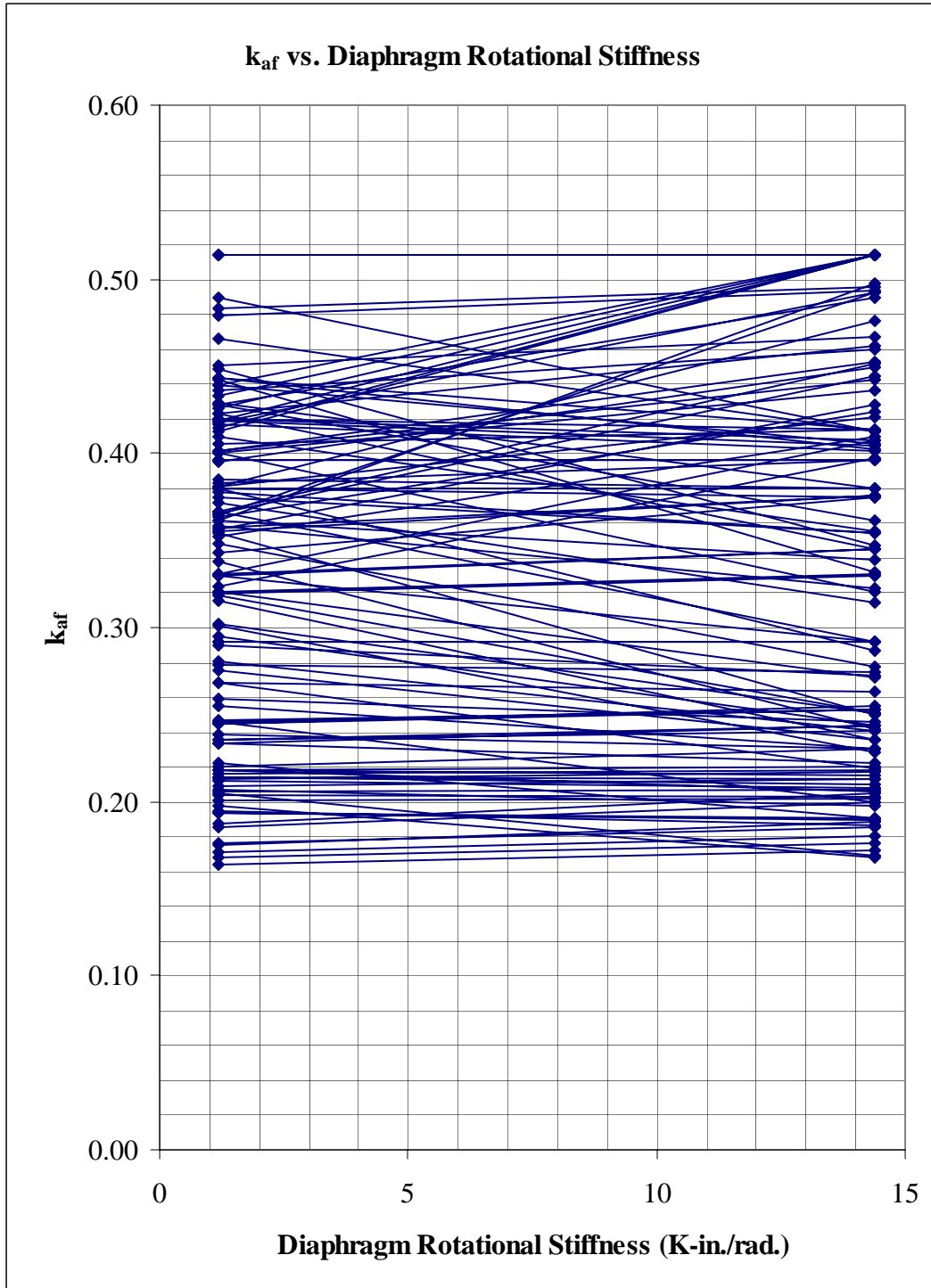

Figure 26: Axial/Flexural Buckling Strength vs. Diaphragm Rotational Stiffness

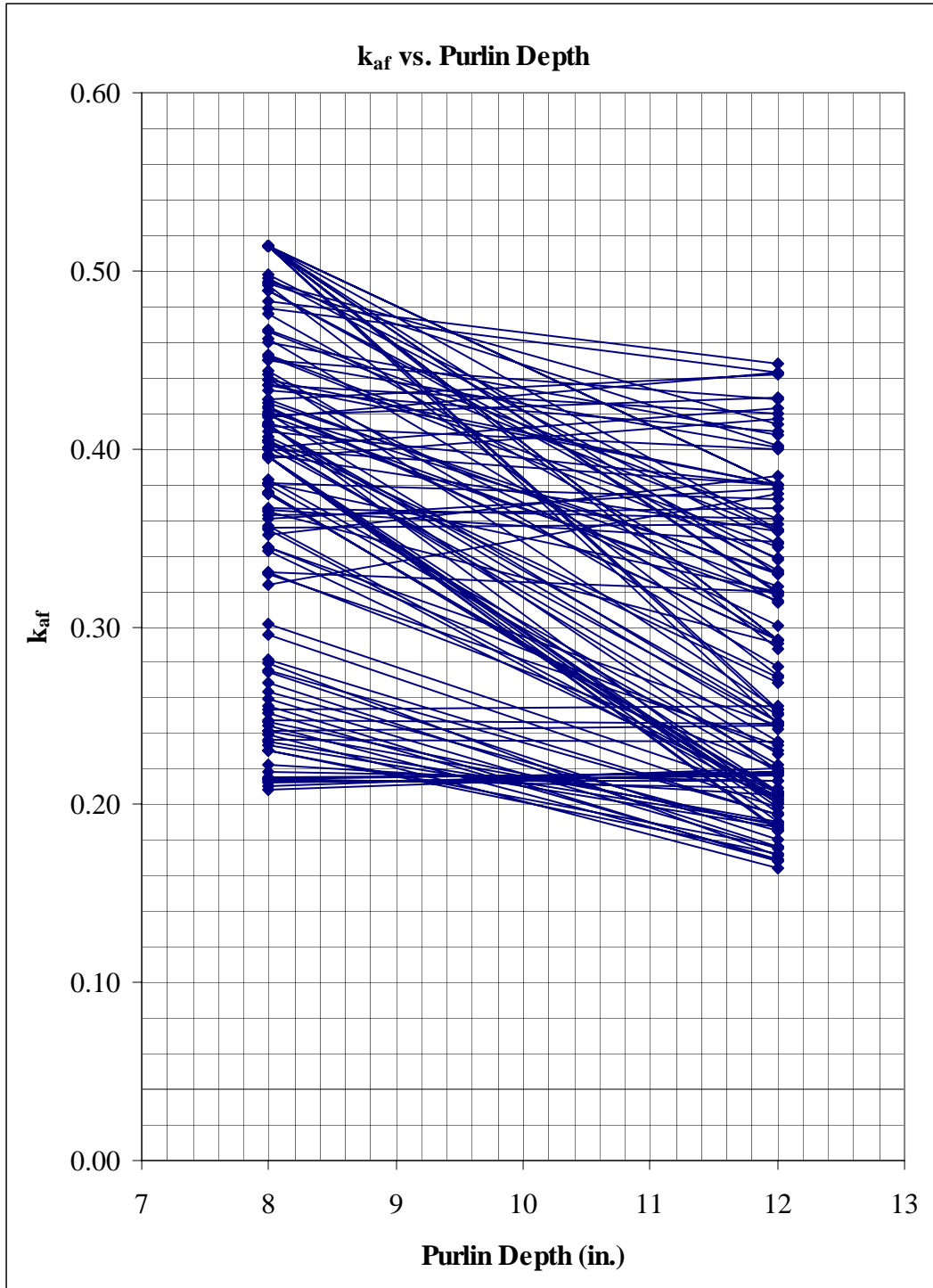

Figure 27: Axial/Flexural Buckling Strength vs. Purlin Depth

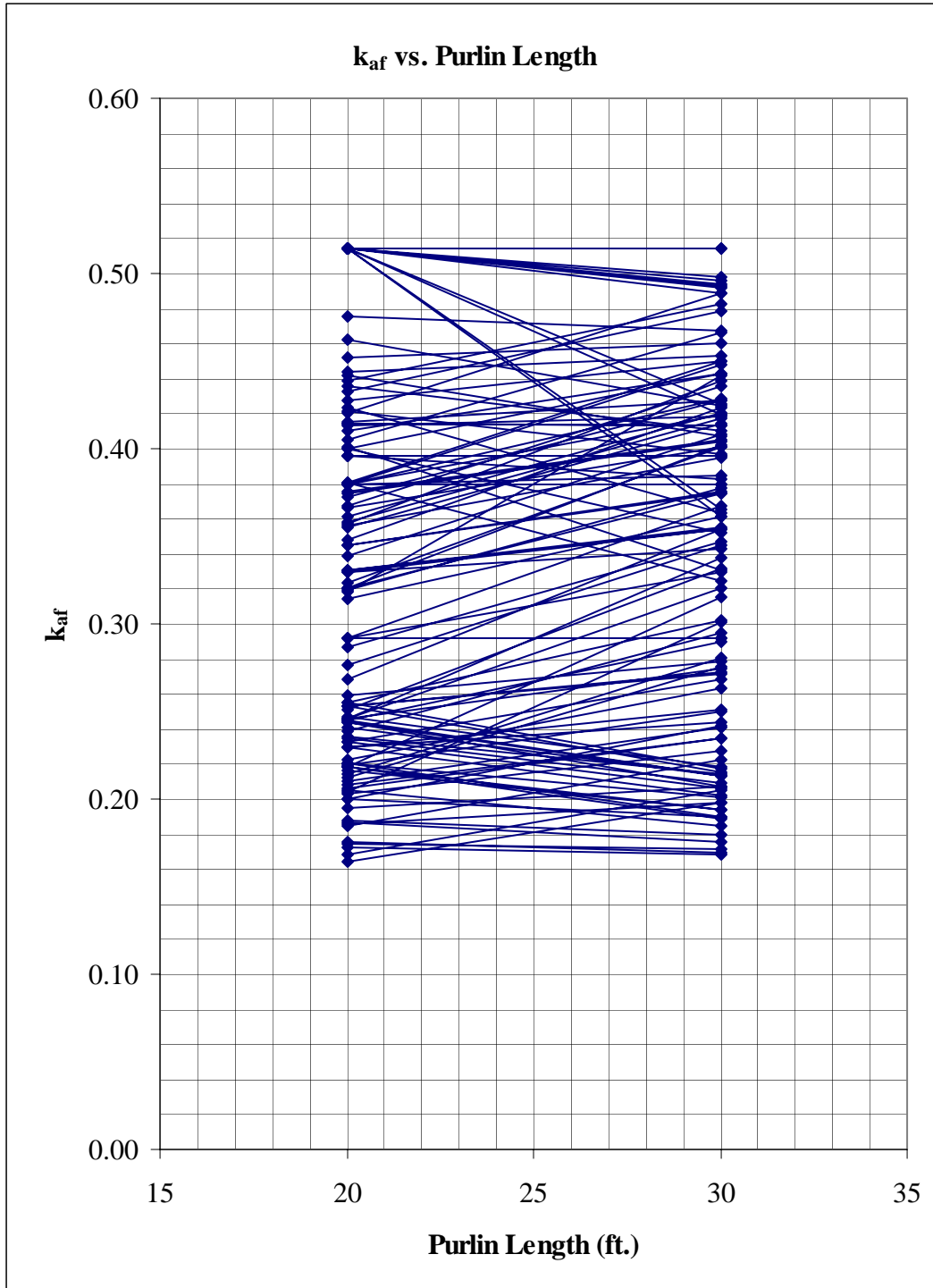

Figure 28: Axial/Flexural Buckling Strength vs. Purlin Length

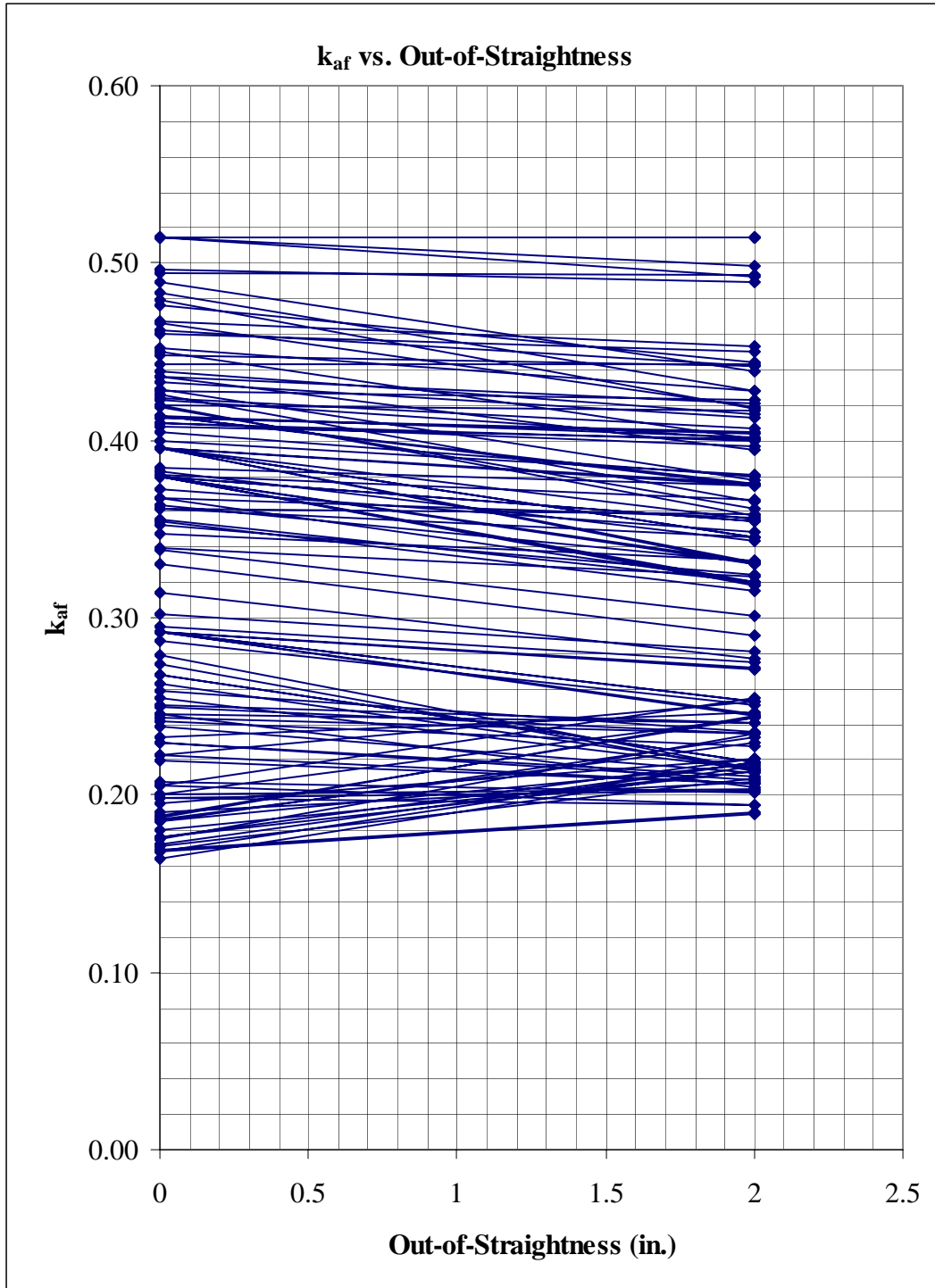

Figure 29: Axial/Flexural Buckling Strength vs. Out-of-Straightness

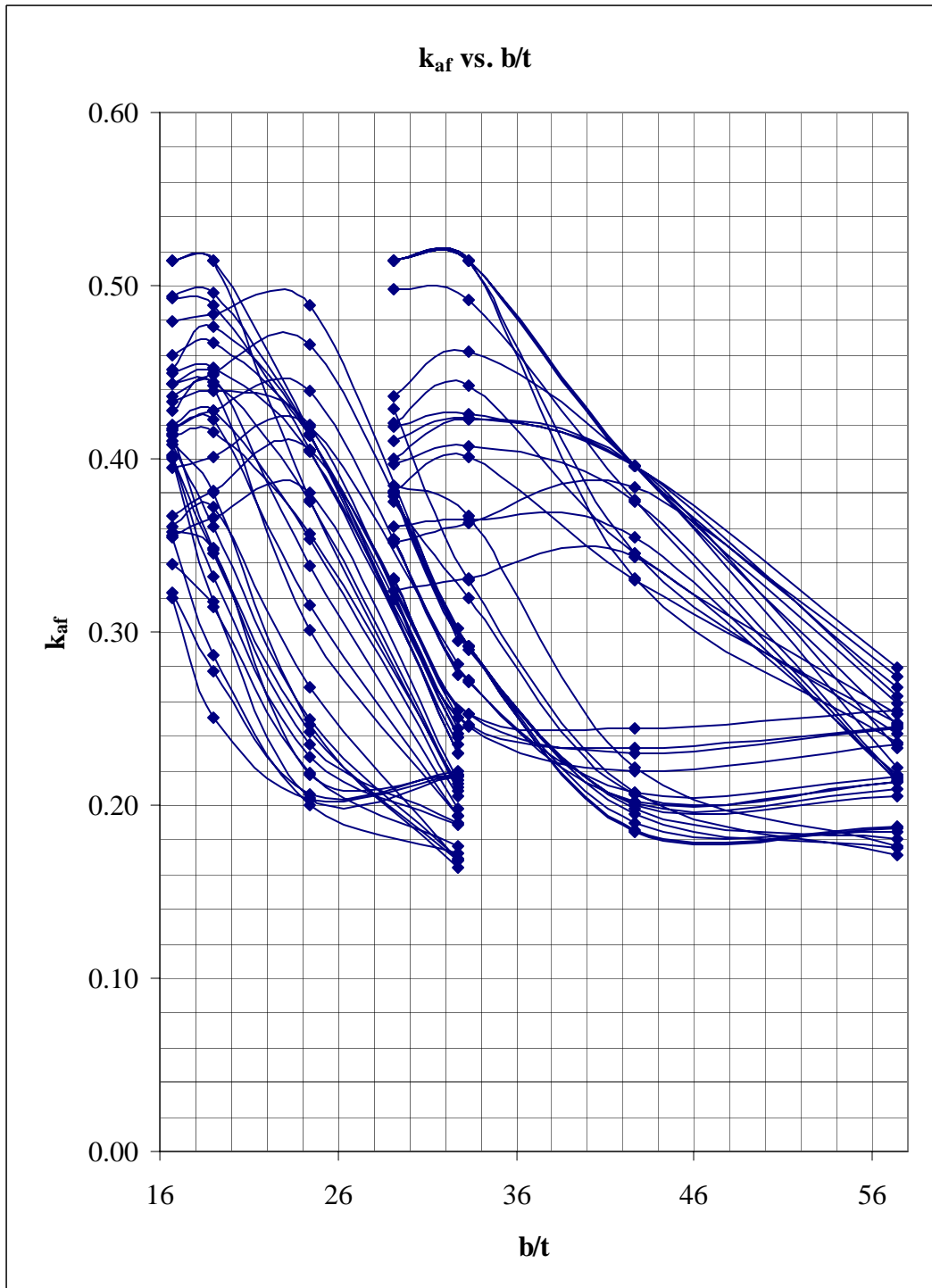

Figure 30: Axial/Flexural Buckling Strength vs.  $\frac{b}{t}$



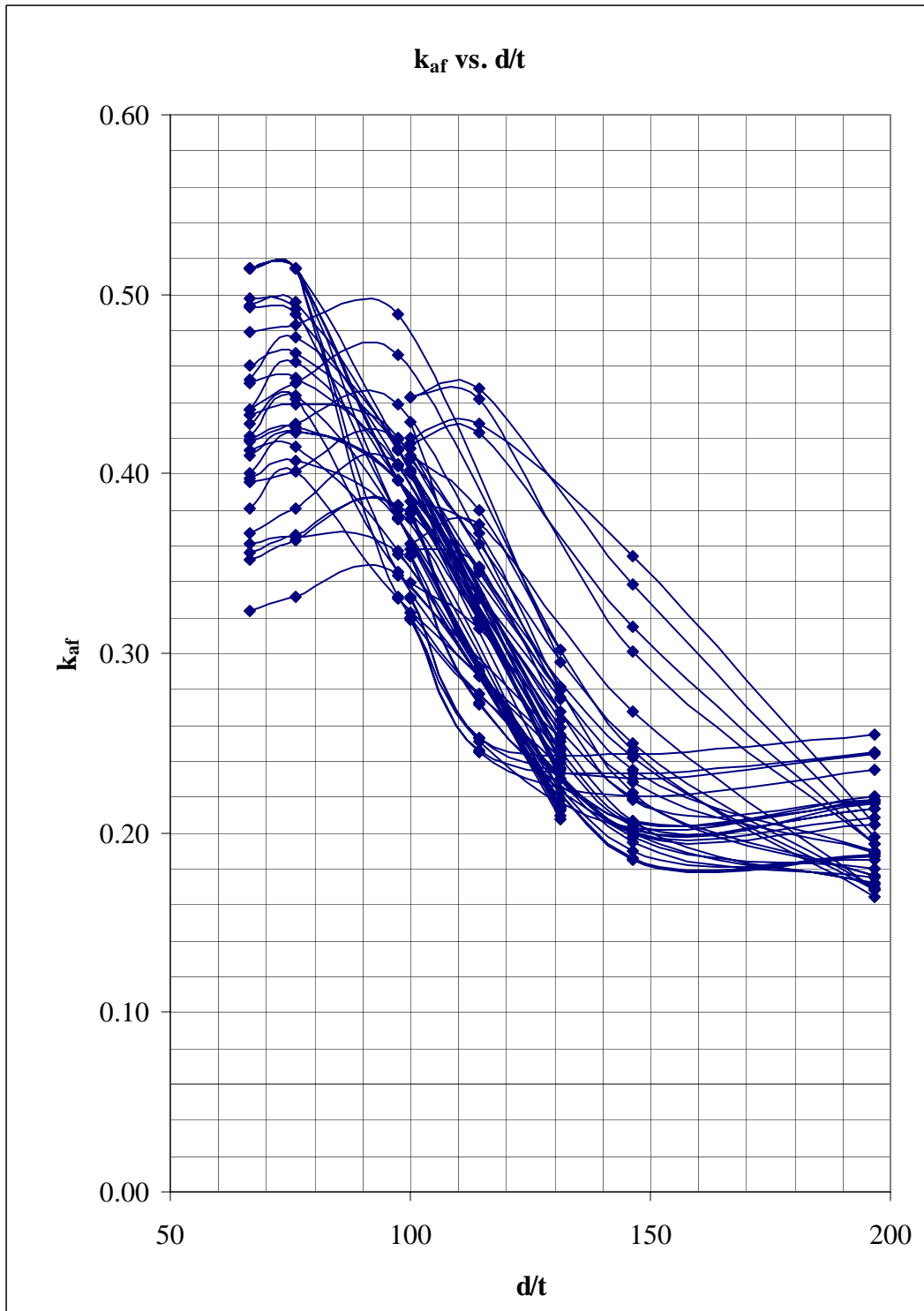

Figure 31: Axial/Flexural Buckling Strength vs.  $\frac{d}{t}$

## 2.4 ELASTIC BUCKLING CORRECTIONS

The results obtained from the finite element analyses are obtained in terms of elastic buckling stresses. To compare the results of the finite element analyses with the experimental results it is required that the elastic buckling stresses be truncated. Listed below are the equations required to make the corrections.

### Flexural buckling strength corrections:

For  $F_e \geq 2.78F_y$ ,

$$F_c = F_y \quad (\text{AISI Spec. Eq. C3.1.2-2})$$

For  $2.78F_y > F_e > 0.56F_y$ ,

$$F_c = \frac{10}{9} F_y \left( 1 - \frac{10F_y}{36F_e} \right) \quad (\text{AISI Spec. Eq. C3.1.2-3})$$

For  $F_e \leq 0.56F_y$

$$F_c = F_e \quad (\text{AISI Spec. Eq. C3.1.2-4})$$

Where:

$F_y$  is the yield strength of the purlin material.

$F_e$  is the elastic flexural buckling stress obtained from the finite element models.

$F_c$  is the actual or corrected flexural buckling stress.

Axial buckling stress corrections:

For  $\lambda_c \leq 1.5$ :

$$F_n = (0.658^{\lambda_c^2}) F_y \quad (\text{AISI Spec. Eq. C4-2})$$

For  $\lambda_c > 1.5$ :

$$F_n = \left[ \frac{0.877}{\lambda_c^2} \right] F_y \quad (\text{AISI Spec. Eq. C4-3})$$

where:

$$\lambda_c = \sqrt{\frac{F_y}{F_e}} \quad (\text{AISI Spec. Eq. C4-4})$$

$F_e$  is the elastic axial buckling stress obtained from the finite element model.

## CHAPTER 3: EXPERIMENTAL PROGRAM

### 3.1 INTRODUCTION

The purpose of conducting experimental tests is to support the findings from the parametric study. The number of tests that were conducted are considerably less than the number of analyses conducted in the finite element modeling phase as they are confirmatory in nature.

Recall from Chapter 2 that the relationship of interest was the ratio of the axial buckling strength to the flexural uplift buckling strength, termed  $k_{af}$ . To obtain an experimental  $k_{af}$ , axial tests and flexural uplift base tests must be conducted.

### 3.2 TEST SPECIMENS

Due to limited resources, tests were selected on availability of relevant existing test data. Manufacturers were sought that had existing flexural uplift base test data. With this situation, only axial tests of samples identical to the flexural tests needed to be conducted.

Based on the uplift base test data that was collected, four test assemblies were chosen to fit within the resource restraints. One of the objectives in selecting the experimental axial load tests was to obtain a sample of each panel type as illustrated in Figure 3 of Chapter 1. By selecting each panel type, the influence of varying diaphragm strength and stiffness would be incorporated into the experimental phase of the research.

Following is a description of each of the standing seam roof assemblies tested.

Assembly #1:

- Panel type: Trapezoidal (24-inch coverage)
- Clip type: Sliding (2 screws placed across the width of the flange)
- Purlin Geometry: 0.120 x 2.5 x 8.5 x 30 feet long
- Insulation: 6-inch high density fiberglass insulation

Assembly #2:

- Panel type: Pan (16-inch coverage)
- Clip type: Sliding (2 screws placed at the center of the purlin flange)
- Purlin Geometry: 0.120 x 2.5 x 8.5 x 30 feet long
- Insulation: 6-inch high density fiberglass insulation plus thermal block (styrofoam insulation) placed between each clip

Assembly #3:

- Panel type: Pan (18-inch coverage, panel was not seamed)
- Clip type: Sliding (2 screws placed across the width of the flange)
- Purlin Geometry: 0.100 x 2.5 x 8 x 23 feet long
- Insulation: Thermal block (styrofoam insulation) placed between each panel clip

Assembly #4:

- Panel type: Pan (18-inch coverage, panel was not seamed)
- Clip type: Sliding (2 screws placed across the width of the flange)
- Purlin Geometry: 0.060 x 2.5 x 8 x 23 feet long
- Insulation: Thermal block (styrofoam insulation) placed between each panel clip

### 3.3 TEST ASSEMBLY

#### 3.3.1 AXIAL TESTS

A schematic of the axial test setup is shown in Figures 32 through 34. A series of strain gages was applied to each set of test purlins. Four strain gages were applied to the center of each flange of the purlins at the center of the purlin length. The strain gages were applied so that the induced bending moment in the purlin, resulting from the accidental load eccentricities, purlin camber, sweep, etc., could be calculated. By knowing the magnitude of the bending moment, the flexural stresses could be determined and an equivalent axial load could be calculated.

The axial load was applied to the purlin via a hydraulic jack which was attached to a load beam. The load beam transferred the applied load to the purlin via web bolts. The web bolts were centered over the depth of the purlin to minimize the amount of strong axis bending moment induced during testing. After the holes had been drilled, the loading beams were bolted in place and then carefully measured to center the centroid of the load beam over the depth of the purlin. Each loading beam consisted of two (2) C10x15.3 members, webs back-to-back with a 1-1/4 inch separation, welded to an

endplate. When the load beams were properly positioned, all of the bolts were secured and the loading rod was threaded through the loading beams. The loading rod was a 1-1/4 inch diameter high-strength post-tensioning rod. The purpose of the loading rod was to pull the loading beams together thus applying the necessary compression in the purlins.

The next step was to construct the roof. The first step in constructing the roof was to determine the required panel layout such that the flat portion of the standing seam roof panel would be located at the center of the purlin length. This was required so that the strain gages, that were applied to each flange, would not be damaged. The next step was to add the insulation. After installing the insulation, the roof panels were installed. Panels were installed sequentially by laying one panel on top of the purlin flanges then attaching a clip to the male end of the panel. The panel clip was then attached to the purlin flange via tech screws (a self-tapping structural screw). After the tech screws had been installed, the female end of the next panel was positioned over the male end. This process was repeated until the entire roof was complete. Thorough inspection was required throughout the process to ensure that the seams were properly engaged. If not properly engaged during installation, the panels could be damaged during the seaming process. Upon completion of the roof assembly, a continuous section of L1x1x1/8 edge angle was attached to the free edges of each standing seam roof panel. The attachment of the edge angle was accomplished by installing a tech screw through the panel and edge angle directly on either side of the high rib of the standing seam roof panel. After the edge angle had been applied, the roof panel was seamed (if required). The seaming process, in the cases of the tests conducted, utilized a mechanical seaming tool. To

explain the result of this process reference is made to Figure 5 in Chapter 1. Figure 5 shows how an unseamed panel looks prior to the seaming operation. As the seamer tool

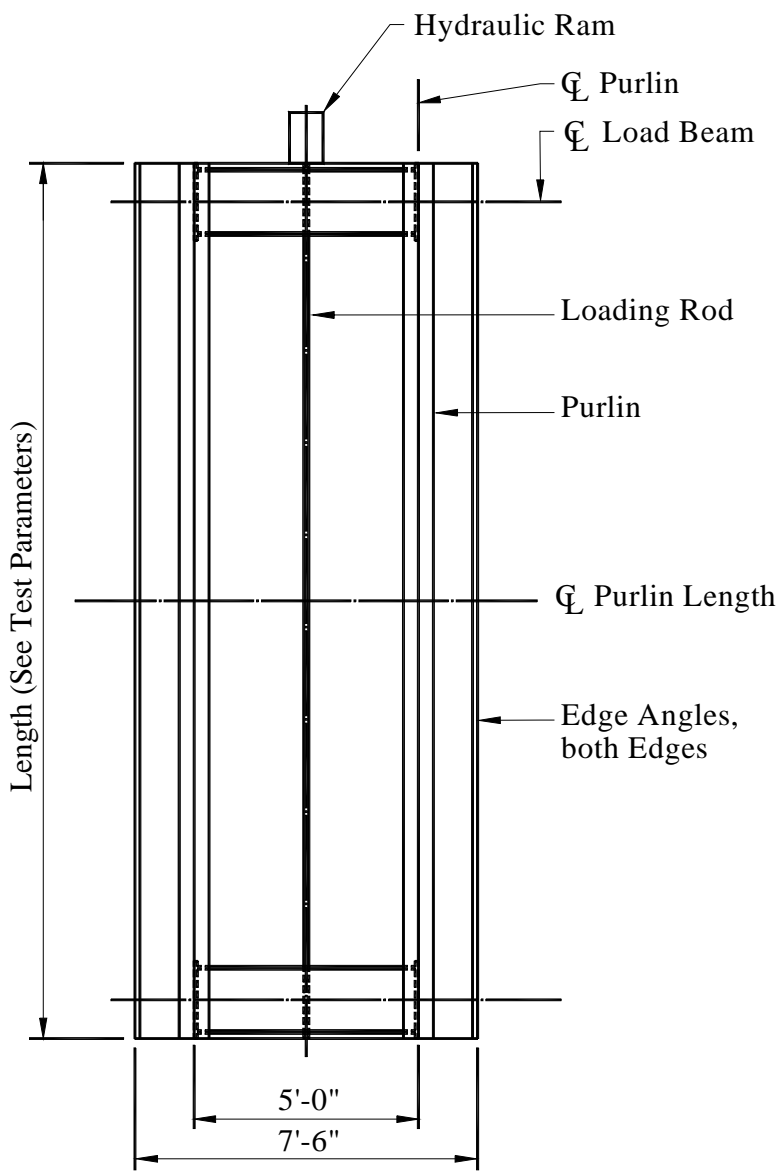

Figure 32: Plan View of Axial Test Set up



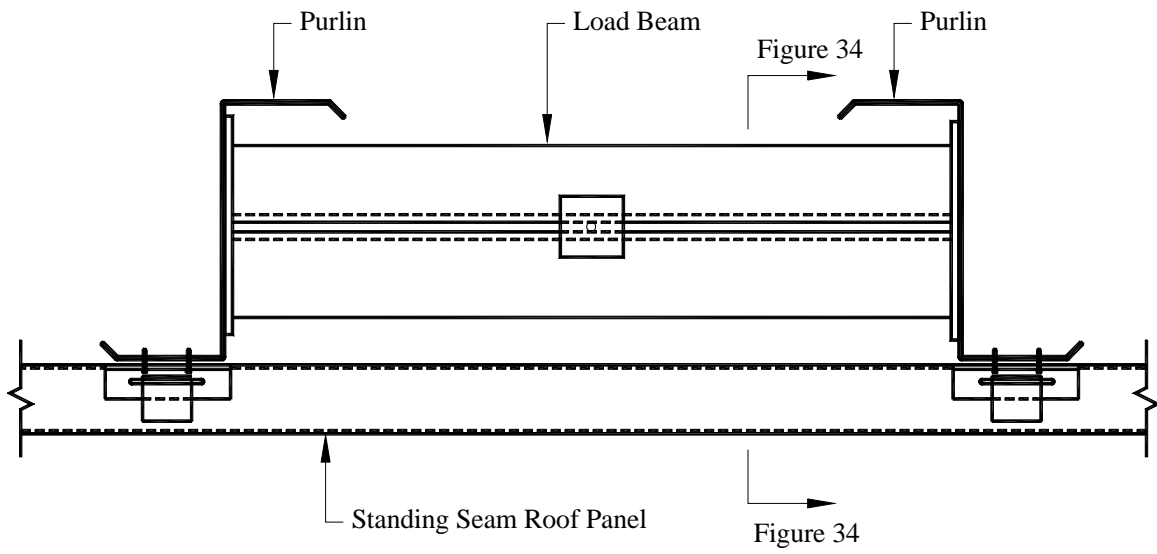

Figure 33: End View of Axial Test Set up

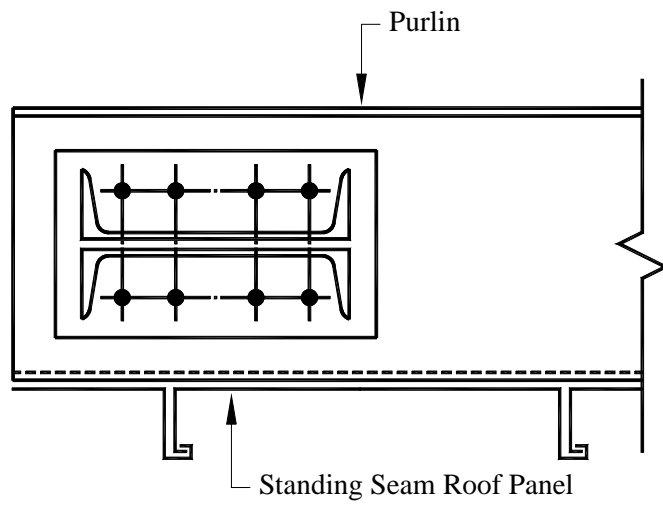

Figure 34: Section Through End View of Test Set up

passes over the unseamed panel, it progressively rolls the panel into a tight configuration as is shown in Figure 35.

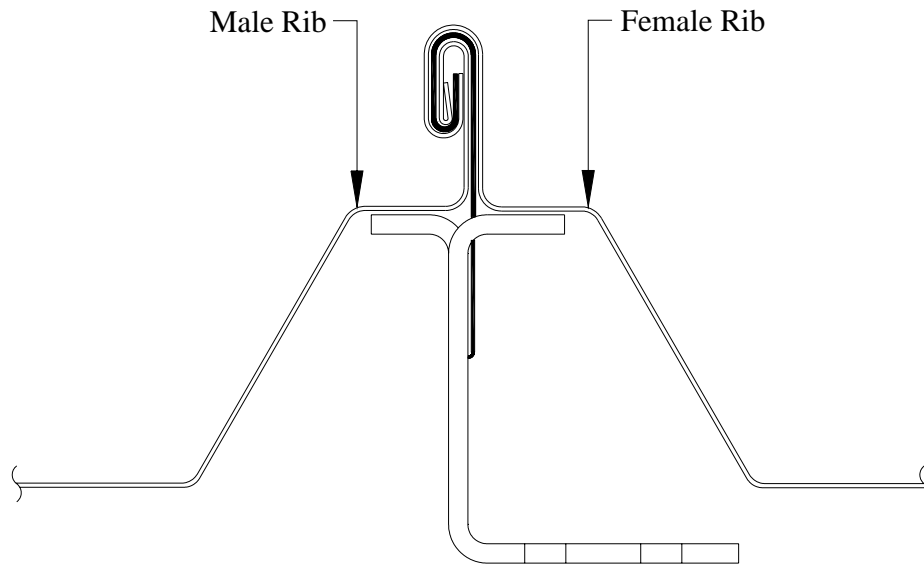

Figure 35: Seamed Cross-Section of Standing Seam Roof Panel

With the assembly completed, the roof was now ready to be moved to its test position. To properly view the purlins during the test, the entire roof needed to be turned upside down. With the aid of two overhead cranes the assembly was picked up and turned over utilizing the loading rod. Once upside down, the roof assembly was lowered to the ground where it rested on a series of rollers. In trying to simulate a condition of pure axial load, it was important to eliminate as much bending as possible. By testing on the ground, essentially all of the bending moment due to the self-weight of the assembly was eliminated.

As a means of checking the bending moments obtained from the strain gages, dial gages were positioned in selected locations at each purlin. By measuring the deflection

of each purlin at the midspan and at each end, an approximated moment could be determined corresponding to the deflected shape. Vertical deflections were taken at each end and at midspan of each purlin and horizontal deflections were taken at the midspan of each purlin. Horizontal deflections were not measured at the purlin ends because the purlins were erected in opposing directions and due to the fact that they were locked together via the load beams.

Prior to conducting each test, the sweep (initial lateral deformation) and camber (initial vertical deformation) was measured for each purlin (see APPENDIX 5 for measurements). Additional measurements included the location of the centroid of the load beam with respect to the purlin centroid at each of the four attachment locations (see APPENDIX 5 for measurements).

Due to the magnitude of the expected loading, the load cell and hydraulic jack used had a capacity of 100 kips. The load cell was calibrated, using certified testing equipment, prior to its use in this series of axial load tests.

### 3.3.2 FLEXURAL TESTS

The test setup for the flexural uplift tests is shown in Figure 36. To apply the flexural load to the roof required that the entire assembly be constructed inside a pressure chamber. The pressure chamber was large enough to allow the roof system to deflect laterally and vertically without impeding the deflection. The walls and floor of the pressure chamber were sealed against air leakage. The roof assembly provided the remaining seal for the pressure chamber and was sealed with the aid of a six-mil polyethylene membrane. The membrane was placed between the standing seam panel

and the purlin flange. When the chamber was pressurized, the membrane distributed a uniform load to the system thus causing uplift on the standing seam roof system.

Sufficient folds were included to allow the membrane to fully expand and conform to the contour of the underside of the panels.

Strain gages were not used in the flexural tests. The purpose of using the strain gages in the axial load tests was to determine the amount of unintended bending moment in the purlins. By reviewing the strain gage data, during the initial stages of the axial test, allowed the hydraulic jack to be adjusted to minimize the moment in the purlins. In the flexural tests, axial load does not exist in the purlins. Catenary forces are relieved in the purlins by having slotted holes in the purlin to support beam connections.

Three measurements were recorded at the midspan of the roof assembly. Vertical deflections were measured over each purlin as well as the lateral translation of the purlins. Each set of purlins tested were oriented with their flanges facing in the same direction.

The end connection details differed from the axial load tests. Each purlin end was bolted to a support beam, which was in turn anchored to a support. Details varied from bolting the bottom flange of the purlin to the support beam to using flange bolts in conjunction with a web-bolted connection angle (anti-roll clip). The purpose of anti-roll clips are to provide restraint to prevent the purlin from rolling over when loaded. Figure 37 illustrates the use of anti-roll clips.

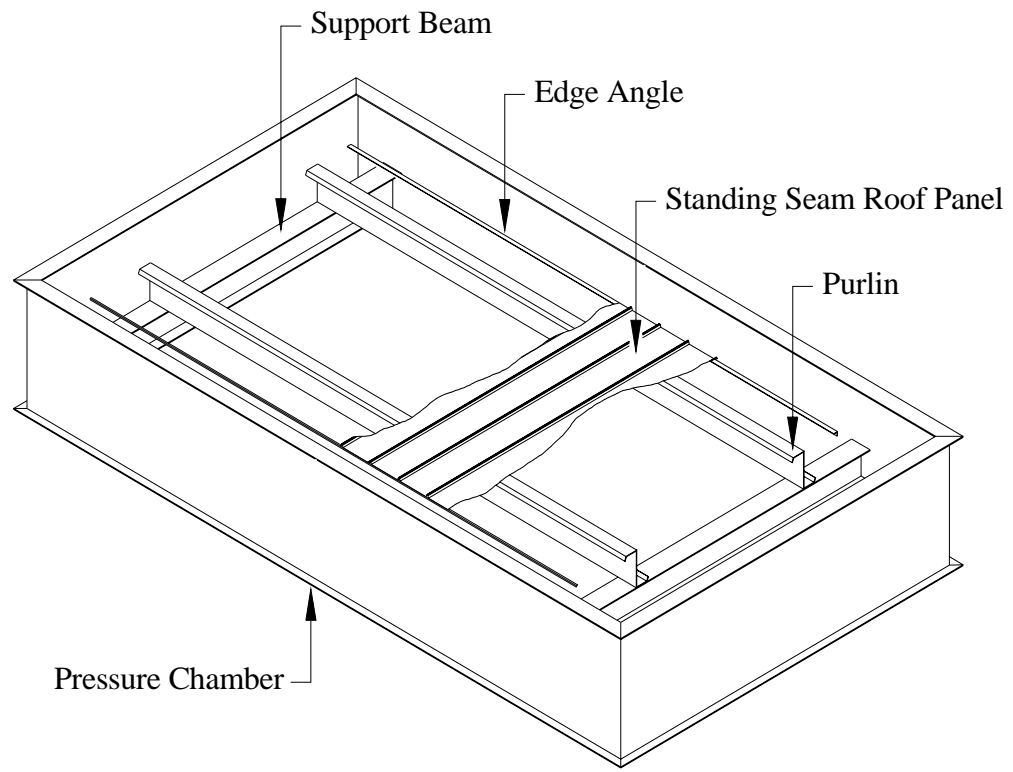

Figure 36: Flexural Test Set up

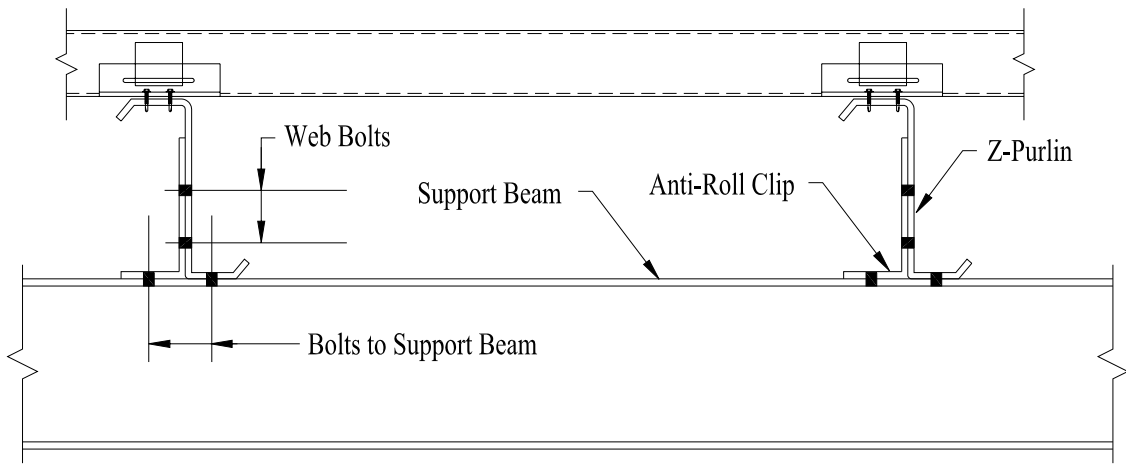

Figure 37: Use of Anti-Roll Clips

### 3.4 TEST PROCEDURE

#### 3.4.1 AXIAL TESTS

Prior to the initiation of each test, all of the dial gages and strain gages were initialized and set to a zero value and then a reference zero reading was taken. Readings and observations were taken at each load increment. Initially, the load increments were set low to get an indication of how the test assembly was performing with regard to strong axis bending moments. If the bending moments were judged to be excessive, the axial load was removed and the load beams were adjusted. After bypassing the lower load levels (about 10 kips) the load was increased using 5-kip increments. These load increments were maintained until failure of the specimen. Failure in each case was defined as the point where the standing seam roof system would accept no further loading due to excessive deflection or loss of strength. After failure occurred, the failure load and geometric observations were recorded. To disassemble the roof required that the assembly be turned over once again. In its original position, the panels were removed and additional failure observations were recorded.

#### 3.4.2 FLEXURAL TESTS

The procedure for conducting each flexural test is outlined under the Base Test Method for Purlins Supporting a Standing Seam Roof in Appendix A of the AISI Cold-Formed Steel Design Manual, Supplement No. 1<sup>10</sup>.

### 3.5 TEST RESULTS

The results of the axial and flexural tests are tabulated in Table 1 and Table 2, respectively. Table 3 contains the results of tension tests that were conducted per the requirements of ASTM A370 (Standard Test Methods and Definitions for Mechanical Testing of Steel Products). Table 4 shows the geometrical dimensions of each failed purlin. Test numbers described as A1, F1, etc. pertain to axial and flexural test results, respectively. The number designation of 1, 2, 3 or 4 pertain to the standing seam roof assembly used, as described in Section 3.2.

Test No.	Failure Load, (kips)	Failure Mode
A1	31.1	1, 2
A2	35.0	1
A3	27.4	3
A4	10.5	3

Table 1: Results of Axial Tests

Test No.	Nominal Span, Ft.	Test Moment, Ft.-Kip	Failure Mode
F1	30	10.3	2, 5
F2	30	9.8	4
F3	23	9.3	4, 2
F4	23	4.9	4

Table 2: Results of Flexural Tests

Failure Mode Key:

1. Lateral Buckle of Unsupported Flange.
2. Clips sheared.
3. Clip failure, panel seam not adequate to laterally support purlin. Clips slid within seam.
4. Lateral torsional inelastic buckling of flange and web at maximum moment region.
5. Purlin rolled (lateral torsional buckle, no local buckling).



Test No.	Fy (ksi)	Fu (ksi)	Elongation (%)
A1	50.5	74.8	20.2
A2	54.2	76.3	18.9
A3	67.1	84.0	20.5
A4	67.0	85.3	20.6
F1	56.3	80.4	21.1
F2	59.6	78.6	20.1
F3	54.6	67.3	17.7
F4	45.9	58.2	22.3

Table 3: Tension Test Results

Test No.	H, in.	t, in.	B <sub>1</sub> , in.	B <sub>2</sub> , in.	L <sub>1</sub> , in.	L <sub>2</sub> , in.	θ <sub>1</sub> , Deg.	θ <sub>2</sub> , Deg.
A1	8.52	0.120	2.38	2.37	0.83	0.87	53.0	53.0
A2	8.53	0.116	2.37	2.55	0.87	0.83	53.0	55.0
A3	7.93	0.095	2.38	2.46	0.95	0.88	52.0	46.5
A4	7.93	0.060	2.38	2.43	0.88	0.97	42.0	50.0
F1	8.35	0.116	2.52	2.46	0.99	0.87	53.5	49.0
F2	8.38	0.118	2.48	2.48	1.05	0.82	54.0	54.0
F3	8.00	0.100	2.71	2.39	0.93	1.13	53.5	49.0
F4	8.00	0.059	2.48	2.50	1.09	0.96	46.0	46.5

Table 4: Dimensions of Failed Members

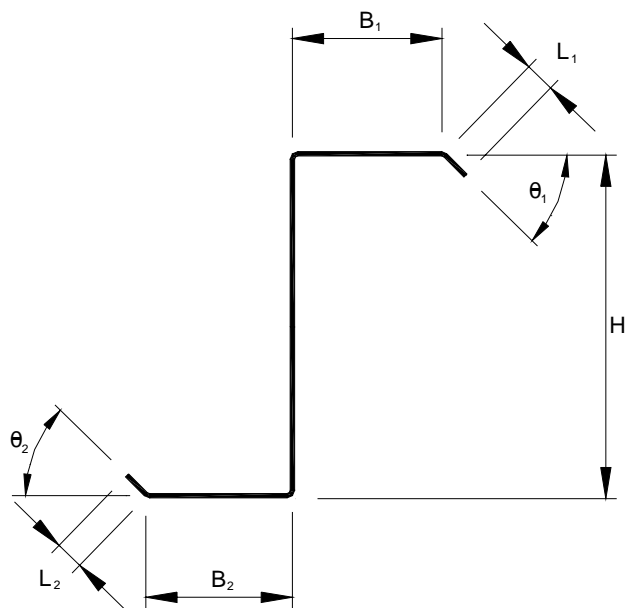

### 3.6 TEST EVALUATION

The initial evaluation required that the stresses resulting from the bending moments be “backed out” of the results of axial load tests A1 through A4. Thus resulting in an equivalent pure axial load result. Determining the amount of moment present in the failed purlin was accomplished by averaging the strain readings given at each purlin flange (see APPENDIX 6 for sample calculation). The average strain reading was converted into the average axial stress in the purlin using Hooke’s Law. The deviation from the average stress was the bending moment in the purlin. Using an interaction equation to account for the combined axial and bending forces, an equivalent axial load was calculated.

Due to the method of load application in the axial load tests, weak axis end restraint has been introduced via the bolted end plate connections. When this fixed ended condition was modeled with finite elements, it contributed up to a 25 percent increase in axial load depending on the purlin thickness and mode of failure. Thin purlins, in which local buckling was the failure mode, experienced no increase in axial load capacity due to the end fixity. As the purlin thickness increased so did the effect on the axial load. Based on these results, the corrected axial loads obtained from the tests were reduced by 25 percent. In field applications, strut-purlins are typically connected to rafter beams via flange bolts. Although in some cases bolted or welded clips are used to attach purlins to rafter beams, the end fixity provided from the typical field connections is much smaller than what was provided in the axial tests.

The experimental values of  $k_{af}$  have been summarized in Table 5.

Test No.	Axial Load, (kips)	Gross Area, (in <sup>2</sup> )	Axial Stress, (ksi)	Bending Moment, (ft-kip)	Effective Section Modulus (in <sup>3</sup> )	Bending Stress, (ksi)	$k_{af}$
A1	24.9	1.71	14.6	-	-	-	0.48
F1	-	-	-	10.27	4.05	30.4	
A2	27.5	1.67	16.5	-	-	-	0.58
F2	-	-	-	9.76	4.10	28.5	
A3	20.8	1.33	15.6	-	-	-	0.47
F3	-	-	-	9.28	3.36	33.1	
A4	8.1	0.85	9.5	-	-	-	0.33
F4	-	-	-	4.89	2.02	29.1	

Table 5: Experimental Values of  $k_{af}$

## CHAPTER 4: RESULTS, DISCUSSION, AND COMPARISON OF COMPUTER MODELING W/EXPERIMENTAL PROGRAM

It should be reiterated that the objective of this research was to determine if a relationship between the axial buckling strength and flexural buckling strength in Z-purlins supporting standing seam roofs could be established. While the computer models are not able to predict the results of either the axial tests or flexural tests within a reasonable degree of accuracy, it is not the axial capacity or the flexural capacity that is of interest. It has already been shown that the solution to obtaining the flexural capacity of a standing seam roof system can only be achieved by conducting experimental tests. The drawback with the computer modeling is that only element stiffness can be modeled. In actuality, there are many strength related issues that factor into the ultimate capacity. By conducting a non-linear analysis, one would expect that the results obtained would be more accurate. Therefore, while the computer modeling does not accurately predict the axial or flexural loads themselves, it is the strength ratio that is of importance. Tables 6 and 7 show the results of the finite element analyses compared with the experimental results. The deviations between the experimental results and the finite element results result from the following:

- The values of the diaphragm stiffness and the diaphragm rotational stiffness for each of the experimental tests have been approximated. Without conducting separate tests, these values cannot be determined.
- As mentioned previously, the finite element model can only model the stiffness of the standing seam roof system. The strength characteristics of the

assembly cannot be reflected by conducting a linear elastic buckling analysis as was performed. One would expect that by conducting a nonlinear buckling analysis that the results would be improved.

Of all the parameters investigated, the best correlation, with respect to the factor  $k_{af}$ , was obtained with  $\frac{d}{t}$ . Comparing the analytical and experimental results shows that the experimental values obtained for  $k_{af}$  are within the range of the analytical values (see Figure 38).

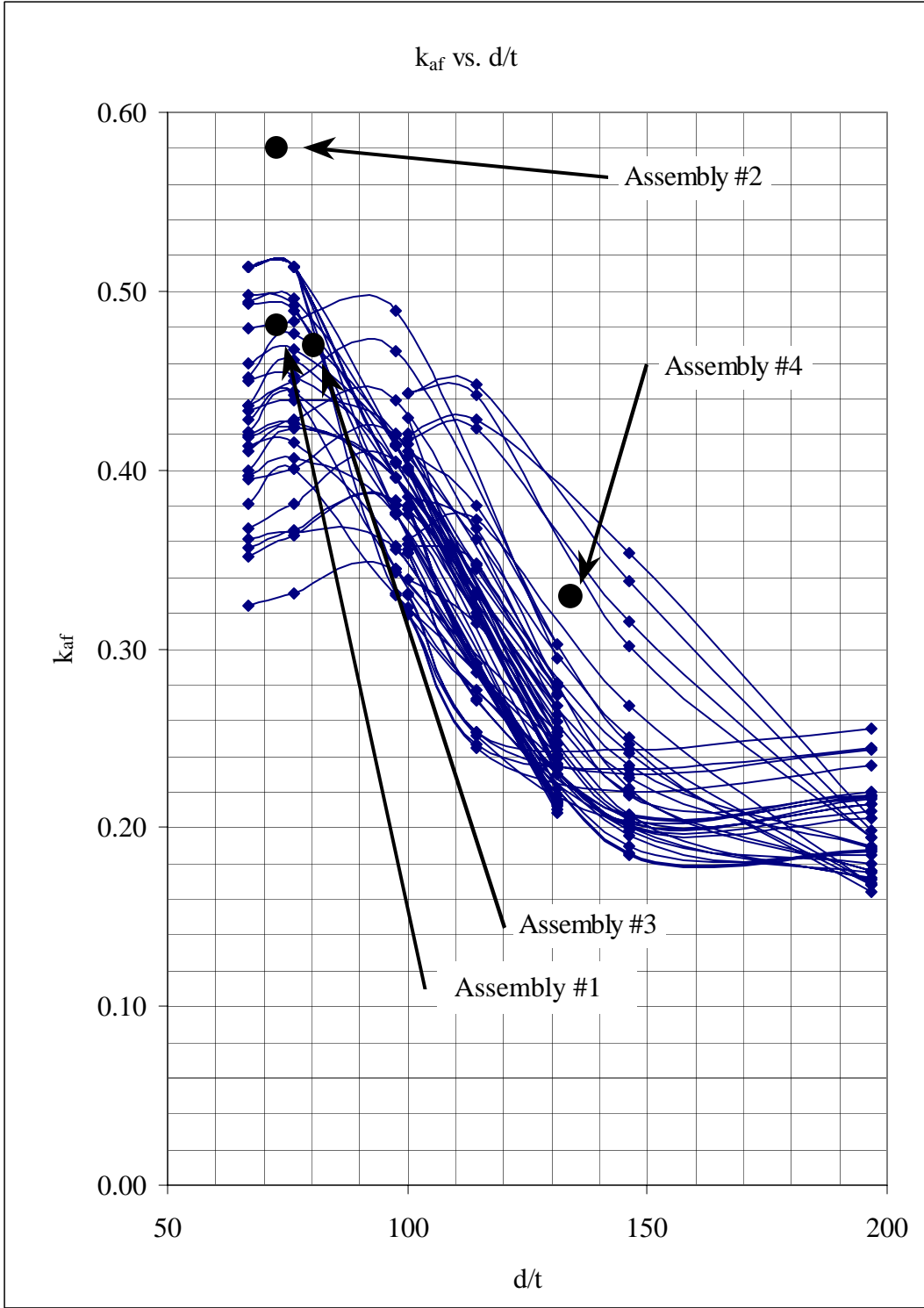

Figure 38: Experimental vs. Analytical  $k_{af}$  Values

Assembly No.	FEM Results, kips	Experimental Results, kips	FEM/Experimental Results
1	42.5	24.9	1.71
2	33.8	27.5	1.23
3	29.8	20.8	1.43
4	7.4	8.1	0.91

Table 6: Comparison of Experimental and FEM Axial Tests

Assembly No.	FEM Results, ft.-kips	Experimental Results, ft.-kips	FEM/Experimental Results
1	17.6	10.3	1.71
2	18.0	9.8	1.84
3	17.1	9.3	1.85
4	6.7	4.9	1.36

Table 7: Comparison of Experimental and FEM Flexural Tests



## CHAPTER 5: CONCLUSIONS AND RECOMMENDATIONS

As can be seen from Figure 38, a relationship between  $k_{af}$  and  $\frac{d}{t}$  can be determined. Based on the amount of scatter present in the analytical research, a solution that incorporates the lower bound is suggested. Illustrated in Figure 39 is the proposed curve drawn through the analytical data. While a number of data points fall below the curve at the high values of  $\frac{d}{t}$ , it should be noted that the current AISC Specification limits  $\frac{d}{t}$  to 170. Shown in Figure 40 is the result of removing the data points that exceed 170.

From Figure 40, the relationship between  $k_{af}$  and  $\frac{d}{t}$  can be expressed as shown in Equations 1 through 3.

$$\text{For } \frac{d}{t} \leq 90;$$

$$k_{af} = 0.36$$

Equation 1

$$\text{For } 90 < \frac{d}{t} \leq 130;$$

$$k_{af} = 0.72 - \frac{d}{250t}$$

Equation 2

For  $\frac{d}{t} > 130$ ;

$$k_{af} = 0.20$$

Equation 3

Tables 8 and 9 compare the predicted axial loads resulting from Equations 1 through 3 with the experimental test results. By using a lower bound approach it can be seen that the predicted capacities range from 60 to 76 percent of the experimental test results.

If less conservative results are desired, full-scale tests can be conducted per the requirements of Chapter F of the Cold-Formed Specification<sup>3</sup>.

In concluding this research it is suggested that additional full-scale tests be conducted in an effort to increase the number of experimental data points.

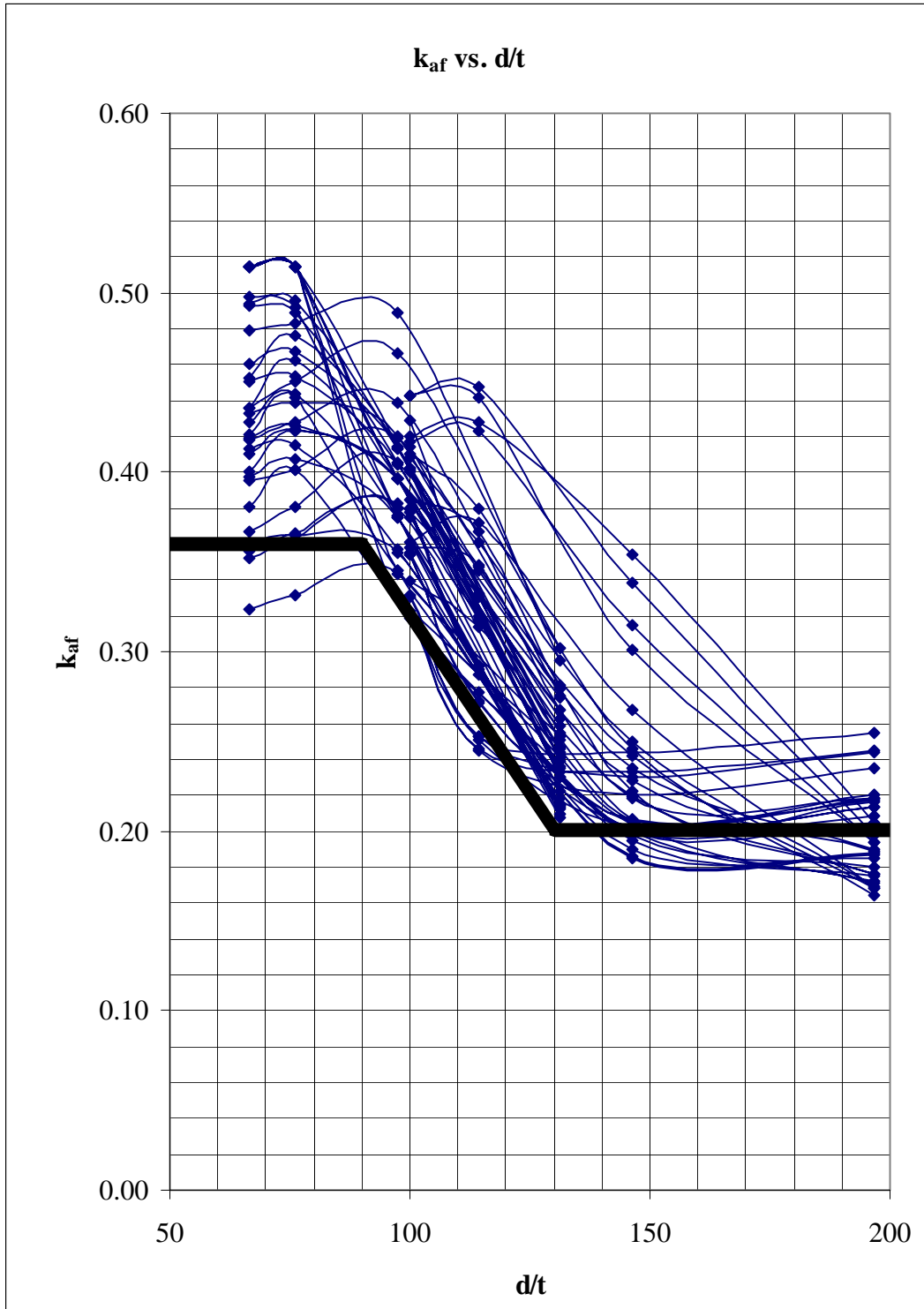

Figure 39: Proposed Solution

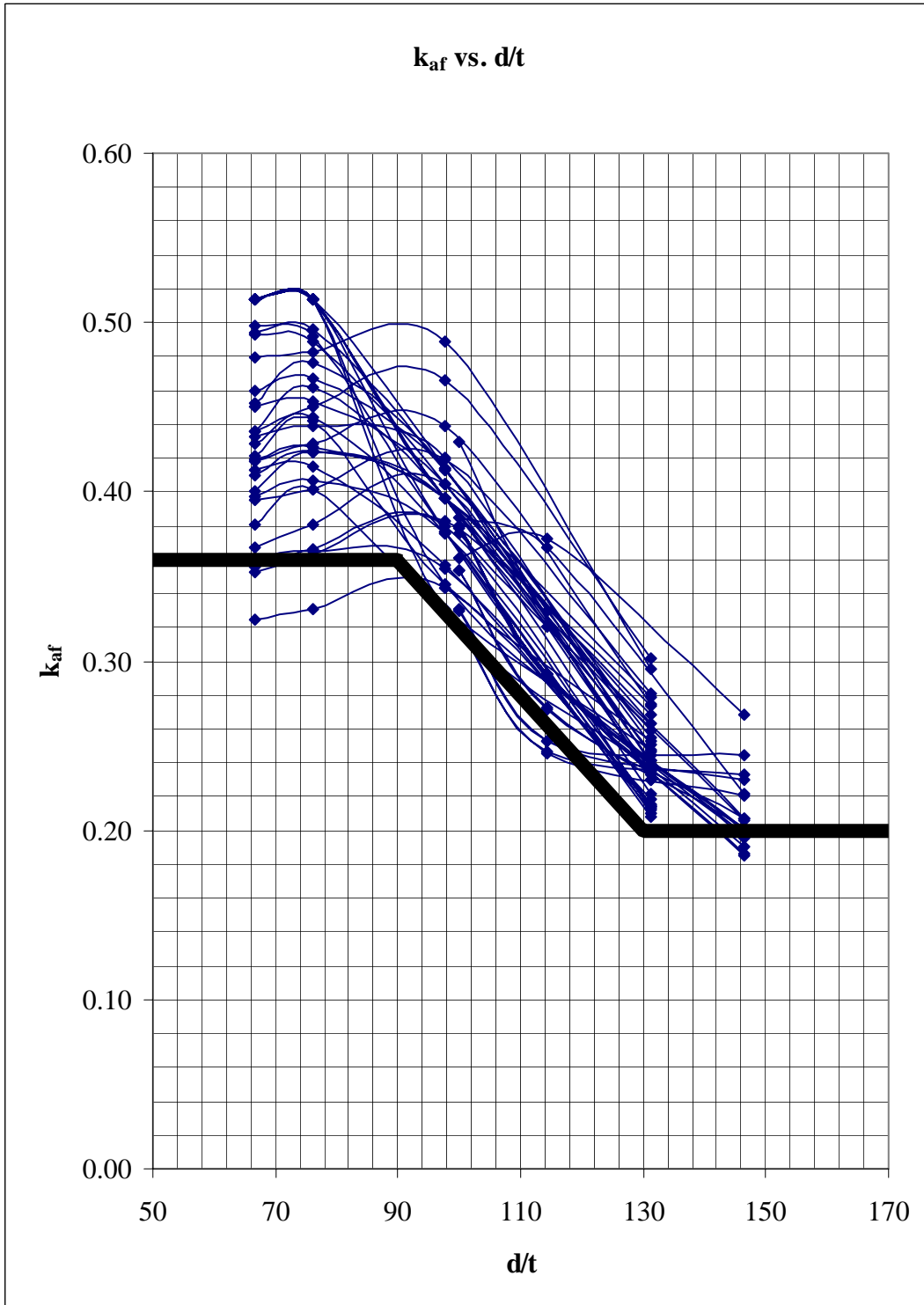

Figure 40: Proposed Solution (Data points removed above  $\frac{d}{t}$  of 170)

Test No.	Flexural Stress at Failure, ksi	d/t	$k_{af}$	Axial Stress, ksi	Gross Area, in <sup>2</sup>	Predicted Load, kips
F1	30.4	71	0.36	10.9	1.71	18.7
F2	28.5	74	0.36	10.3	1.67	17.1
F3	33.1	83	0.36	11.9	1.33	15.8
F4	29.1	133	0.20	5.8	0.85	4.9

Table 8: Predicted Axial Load from Flexural Test Results

Test No.	Predicted, kips	Tested, kips	Predicted/Tested
A1	18.7	24.9	0.75
A2	17.1	27.5	0.62
A3	15.8	20.8	0.76
A4	4.9	8.1	0.60

Table 9: Predicted vs. Experimental Axial Test Results

## **BIBLIOGRAPHY**

1. Simaan, A. (1973). "Buckling of Diaphragm-Braced Columns of Unsymmetrical Sections and Applications to Wall Stud Design." Report No. 353, Department of Structural Engineering, Cornell University, Ithaca, N.Y.
2. Hatch, Jerry (1991). "Strength Evaluation of Strut-Purlins." Report No. CE/VPI-ST90/08, MBMA Project 503, The Charles E. Via, Jr. Department of Civil Engineering, Virginia Polytechnic Institute and State University.
3. American Iron and Steel Institute: "Specification for the Design of Cold-Formed Steel Structural Members", 1996 ed.
4. American Iron and Steel Institute: "A Guide to Designing with Standing Seam Roof Panels", Design Guide CF97-1, August 1997.
5. American Iron and Steel Institute: "Axial Load Capacity of Sheeted Cold-Formed C and Z Members", Report CF93-2, December 1993.
6. LaBoube, R.A., (1986) "Roof Panel to Purlin Connection: Rotational Restraint Factor". International Association for Bridge and Structural Engineering (IABSE) Colloquium, Stockholm.
7. Simaan, A., Pekoz, T., (1976). "Diaphragm Braced Members and Design of Wall Studs". Journal of the Structural Division, ASCE, Vol. 102, ST1.
8. Cold-Formed Steel Design Software Version 3.04. RGS Software, Inc. 2803 NW Chipman Road, Lee's Summit, MO 64081. Phone/Fax 816-524-5596.
9. GT STRUDL, Integrated CAE System for Structural Engineering Analysis and Design. Revision 4, June 1999. Computer Aided Structural Engineering Center, School of Civil and Environmental Engineering, Georgia Institute of Technology, Atlanta, Georgia 30332-0355. Phone 404-894-2260, Fax 404-894-8014.
10. American Iron and Steel Institute: "Specification for the Design of Cold-Formed Steel Structural Members With Commentary", 1996 ed., Supplement No.1, July 30, 1999.

**APPENDIX 1: TEST MATRIX**

Test No.	1	2	3	4	9	10	11	12	17	18	19	20
1a	1a	1a	1a	1a	1a	1a	1a	1a	1a	1a	1a	1a
1b												
2a	2a	2a	2a	2a	2a	2a	2a	2a	2a	2a	2a	2a
2b												
2c												
2d												
3a	3a	3a	3a	3a	3a	3a	3a	3a				
3b									3b	3b	3b	3b
4a	4a	4a	4a	4a					4a	4a	4a	4a
4b					4b	4b	4b	4b				
5a	5a	5a	5a	5a	5a	5a	5a	5a	5a	5a	5a	5a
5b												
6a	6a	6a	6a	6a	6a	6a	6a	6a	6a	6a	6a	6a
6b												
7a	7a	7a			7a	7a			7a	7a		
7b			7b	7b			7b	7b			7b	7b
8a	8a		8a		8a		8a		8a		8a	
8b		8b		8b		8b		8b		8b		8b

Parameter Key:

1a - 2-inch Flange Width

1b - 3.5-inch Flange Width

2a - 0.061-inch Thickness

2b - 0.120-inch Thickness

2c - 0.082-inch Thickness

2d - 0.105-inch Thickness

3a - 0.6 K/in. Diaphragm Stiffness

3b - 2.4 K/in. Diaphragm Stiffness

4a - 1.2 K-in./rad. Diaphragm Rotational Stiffness

4b - 14.4 K-in./rad. Diaphragm Rotational Stiffness

5a - 8-inch Purlin Depth

5b - 12-inch Purlin Depth

6a - 20-foot Length

6b - 30-foot Length

7a - 0-inch Initial Displacement

7b - 2-inch Initial Displacement

8a - Axial Load Model

8b - Uplift Load Model



Test No.	25	26	27	28	33	34	35	36	41	42	43	44
1a	1a	1a	1a	1a	1a	1a	1a	1a	1a	1a	1a	1a
1b												
2a	2a	2a	2a	2a								
2b					2b	2b	2b	2b	2b	2b	2b	2b
2c												
2d												
3a					3a	3a	3a	3a	3a	3a	3a	3a
3b	3b	3b	3b	3b								
4a					4a	4a	4a	4a				
4b	4b	4b	4b	4b					4b	4b	4b	4b
5a	5a	5a	5a	5a	5a	5a	5a	5a	5a	5a	5a	5a
5b												
6a	6a	6a	6a	6a	6a	6a	6a	6a	6a	6a	6a	6a
6b												
7a	7a	7a			7a	7a			7a	7a		
7b			7b	7b			7b	7b			7b	7b
8a	8a		8a		8a		8a		8a		8a	
8b		8b		8b		8b		8b		8b		8b

Parameter Key:

1a - 2-inch Flange Width

1b - 3.5-inch Flange Width

2a - 0.061-inch Thickness

2b - 0.120-inch Thickness

2c - 0.082-inch Thickness

2d - 0.105-inch Thickness

3a - 0.6 K/in. Diaphragm Stiffness

3b - 2.4 K/in. Diaphragm Stiffness

4a - 1.2 K-in./rad. Diaphragm Rotational Stiffness

4b - 14.4 K-in./rad. Diaphragm Rotational Stiffness

5a - 8-inch Purlin Depth

5b - 12-inch Purlin Depth

6a - 20-foot Length

6b - 30-foot Length

7a - 0-inch Initial Displacement

7b - 2-inch Initial Displacement

8a - Axial Load Model

8b - Uplift Load Model

Test No.	49	50	51	52	57	58	59	60	65	66	67	68
1a	1a	1a	1a	1a	1a	1a	1a	1a				
1b									1b	1b	1b	1b
2a									2a	2a	2a	2a
2b	2b	2b	2b	2b	2b	2b	2b	2b				
2c												
2d												
3a									3a	3a	3a	3a
3b	3b	3b	3b	3b	3b	3b	3b	3b				
4a	4a	4a	4a	4a					4a	4a	4a	4a
4b					4b	4b	4b	4b				
5a	5a	5a	5a	5a	5a	5a	5a	5a	5a	5a	5a	5a
5b												
6a	6a	6a	6a	6a	6a	6a	6a	6a	6a	6a	6a	6a
6b												
7a	7a	7a			7a	7a			7a	7a		
7b			7b	7b			7b	7b			7b	7b
8a	8a		8a		8a		8a		8a		8a	
8b		8b		8b		8b		8b		8b		8b

Parameter Key:

1a - 2-inch Flange Width

5a - 8-inch Purlin Depth

1b - 3.5-inch Flange Width

5b - 12-inch Purlin Depth

2a - 0.061-inch Thickness

6a - 20-foot Length

2b - 0.120-inch Thickness

6b - 30-foot Length

2c - 0.082-inch Thickness

7a - 0-inch Initial Displacement

2d - 0.105-inch Thickness

7b - 2-inch Initial Displacement

3a - 0.6 K/in. Diaphragm Stiffness

8a - Axial Load Model

3b - 2.4 K/in. Diaphragm Stiffness

8b - Uplift Load Model

4a - 1.2 K-in./rad. Diaphragm Rotational Stiffness

4b - 14.4 K-in./rad. Diaphragm Rotational Stiffness

Test No.	73	74	75	76	81	82	83	84	89	90	91	92
1a												
1b	1b	1b	1b	1b	1b	1b	1b	1b	1b	1b	1b	1b
2a	2a	2a	2a	2a	2a	2a	2a	2a	2a	2a	2a	2a
2b												
2c												
2d												
3a	3a	3a	3a	3a								
3b					3b	3b	3b	3b	3b	3b	3b	3b
4a					4a	4a	4a	4a				
4b	4b	4b	4b	4b					4b	4b	4b	4b
5a	5a	5a	5a	5a	5a	5a	5a	5a	5a	5a	5a	5a
5b												
6a	6a	6a	6a	6a	6a	6a	6a	6a	6a	6a	6a	6a
6b												
7a	7a	7a			7a	7a			7a	7a		
7b			7b	7b			7b	7b			7b	7b
8a	8a		8a		8a		8a		8a		8a	
8b		8b		8b		8b		8b		8b		8b

Parameter Key:

1a - 2-inch Flange Width

1b - 3.5-inch Flange Width

2a - 0.061-inch Thickness

2b - 0.120-inch Thickness

2c - 0.082-inch Thickness

2d - 0.105-inch Thickness

3a - 0.6 K/in. Diaphragm Stiffness

3b - 2.4 K/in. Diaphragm Stiffness

4a - 1.2 K-in./rad. Diaphragm Rotational Stiffness

4b - 14.4 K-in./rad. Diaphragm Rotational Stiffness

5a - 8-inch Purlin Depth

5b - 12-inch Purlin Depth

6a - 20-foot Length

6b - 30-foot Length

7a - 0-inch Initial Displacement

7b - 2-inch Initial Displacement

8a - Axial Load Model

8b - Uplift Load Model

Test No.	97	89	99	100	105	106	107	108	113	114	115	116
1a												
1b	1b	1b	1b	1b	1b	1b	1b	1b	1b	1b	1b	1b
2a												
2b	2b	2b	2b	2b	2b	2b	2b	2b	2b	2b	2b	2b
2c												
2d												
3a	3a	3a	3a	3a	3a	3a	3a	3a				
3b									3b	3b	3b	3b
4a	4a	4a	4a	4a					4a	4a	4a	4a
4b					4b	4b	4b	4b				
5a	5a	5a	5a	5a	5a	5a	5a	5a	5a	5a	5a	5a
5b												
6a	6a	6a	6a	6a	6a	6a	6a	6a	6a	6a	6a	6a
6b												
7a	7a	7a			7a	7a			7a	7a		
7b			7b	7b			7b	7b			7b	7b
8a	8a		8a		8a		8a		8a		8a	
8b		8b		8b		8b		8b		8b		8b

Parameter Key:

1a - 2-inch Flange Width

5a - 8-inch Purlin Depth

1b - 3.5-inch Flange Width

5b - 12-inch Purlin Depth

2a - 0.061-inch Thickness

6a - 20-foot Length

2b - 0.120-inch Thickness

6b - 30-foot Length

2c - 0.082-inch Thickness

7a - 0-inch Initial Displacement

2d - 0.105-inch Thickness

7b - 2-inch Initial Displacement

3a - 0.6 K/in. Diaphragm Stiffness

8a - Axial Load Model

3b - 2.4 K/in. Diaphragm Stiffness

8b - Uplift Load Model

4a - 1.2 K-in./rad. Diaphragm Rotational Stiffness

4b - 14.4 K-in./rad. Diaphragm Rotational Stiffness

Test No.	121	122	123	124	129	130	131	132	133	134	135	136
1a					1a	1a	1a	1a	1a	1a	1a	1a
1b	1b	1b	1b	1b								
2a					2a	2a	2a	2a	2a	2a	2a	2a
2b	2b	2b	2b	2b								
2c												
2d												
3a					3a	3a	3a	3a	3a	3a	3a	3a
3b	3b	3b	3b	3b								
4a					4a	4a	4a	4a				
4b	4b	4b	4b	4b					4b	4b	4b	4b
5a	5a	5a	5a	5a	5a	5a	5a	5a	5a	5a	5a	5a
5b												
6a	6a	6a	6a	6a								
6b					6b	6b	6b	6b	6b	6b	6b	6b
7a	7a	7a			7a	7a			7a	7a		
7b			7b	7b			7b	7b			7b	7b
8a	8a		8a		8a		8a		8a		8a	
8b		8b		8b		8b		8b		8b		8b

Parameter Key:

1a - 2-inch Flange Width

5a - 8-inch Purlin Depth

1b - 3.5-inch Flange Width

5b - 12-inch Purlin Depth

2a - 0.061-inch Thickness

6a - 20-foot Length

2b - 0.120-inch Thickness

6b - 30-foot Length

2c - 0.082-inch Thickness

7a - 0-inch Initial Displacement

2d - 0.105-inch Thickness

7b - 2-inch Initial Displacement

3a - 0.6 K/in. Diaphragm Stiffness

8a - Axial Load Model

3b - 2.4 K/in. Diaphragm Stiffness

8b - Uplift Load Model

4a - 1.2 K-in./rad. Diaphragm Rotational Stiffness

4b - 14.4 K-in./rad. Diaphragm Rotational Stiffness

Test No.	137	138	139	140	141	142	143	144	145	146	147	148
1a	1a	1a	1a	1a	1a	1a	1a	1a	1a	1a	1a	1a
1b												
2a	2a	2a	2a	2a	2a	2a	2a	2a				
2b									2b	2b	2b	2b
2c												
2d												
3a									3a	3a	3a	3a
3b	3b	3b	3b	3b	3b	3b	3b	3b				
4a	4a	4a	4a	4a					4a	4a	4a	4a
4b					4b	4b	4b	4b				
5a	5a	5a	5a	5a	5a	5a	5a	5a	5a	5a	5a	5a
5b												
6a												
6b	6b	6b	6b	6b	6b	6b	6b	6b	6b	6b	6b	6b
7a	7a	7a			7a	7a			7a	7a		
7b			7b	7b			7b	7b			7b	7b
8a	8a		8a		8a		8a		8a		8a	
8b		8b		8b		8b		8b		8b		8b

Parameter Key:

1a - 2-inch Flange Width

1b - 3.5-inch Flange Width

2a - 0.061-inch Thickness

2b - 0.120-inch Thickness

2c - 0.082-inch Thickness

2d - 0.105-inch Thickness

3a - 0.6 K/in. Diaphragm Stiffness

3b - 2.4 K/in. Diaphragm Stiffness

4a - 1.2 K-in./rad. Diaphragm Rotational Stiffness

4b - 14.4 K-in./rad. Diaphragm Rotational Stiffness

5a - 8-inch Purlin Depth

5b - 12-inch Purlin Depth

6a - 20-foot Length

6b - 30-foot Length

7a - 0-inch Initial Displacement

7b - 2-inch Initial Displacement

8a - Axial Load Model

8b - Uplift Load Model

Test No.	149	150	151	152	153	154	155	156	157	158	159	160
1a	1a	1a	1a	1a	1a	1a	1a	1a	1a	1a	1a	1a
1b												
2a												
2b	2b	2b	2b	2b	2b	2b	2b	2b	2b	2b	2b	2b
2c												
2d												
3a	3a	3a	3a	3a								
3b					3b	3b	3b	3b	3b	3b	3b	3b
4a					4a	4a	4a	4a				
4b	4b	4b	4b	4b					4b	4b	4b	4b
5a	5a	5a	5a	5a	5a	5a	5a	5a	5a	5a	5a	5a
5b												
6a												
6b	6b	6b	6b	6b	6b	6b	6b	6b	6b	6b	6b	6b
7a	7a	7a			7a	7a			7a	7a		
7b			7b	7b			7b	7b			7b	7b
8a	8a		8a		8a		8a		8a		8a	
8b		8b		8b		8b		8b		8b		8b

Parameter Key:

1a - 2-inch Flange Width

5a - 8-inch Purlin Depth

1b - 3.5-inch Flange Width

5b - 12-inch Purlin Depth

2a - 0.061-inch Thickness

6a - 20-foot Length

2b - 0.120-inch Thickness

6b - 30-foot Length

2c - 0.082-inch Thickness

7a - 0-inch Initial Displacement

2d - 0.105-inch Thickness

7b - 2-inch Initial Displacement

3a - 0.6 K/in. Diaphragm Stiffness

8a - Axial Load Model

3b - 2.4 K/in. Diaphragm Stiffness

8b - Uplift Load Model

4a - 1.2 K-in./rad. Diaphragm Rotational Stiffness

4b - 14.4 K-in./rad. Diaphragm Rotational Stiffness

Test No.	161	162	163	164	165	166	167	168	169	170	171	172
1a												
1b	1b	1b	1b	1b	1b	1b	1b	1b	1b	1b	1b	1b
2a	2a	2a	2a	2a	2a	2a	2a	2a	2a	2a	2a	2a
2b												
2c												
2d												
3a	3a	3a	3a	3a	3a	3a	3a	3a				
3b									3b	3b	3b	3b
4a	4a	4a	4a	4a					4a	4a	4a	4a
4b					4b	4b	4b	4b				
5a	5a	5a	5a	5a	5a	5a	5a	5a	5a	5a	5a	5a
5b												
6a												
6b	6b	6b	6b	6b	6b	6b	6b	6b	6b	6b	6b	6b
7a	7a	7a			7a	7a			7a	7a		
7b			7b	7b			7b	7b			7b	7b
8a	8a		8a		8a		8a		8a		8a	
8b		8b		8b		8b		8b		8b		8b

Parameter Key:

1a - 2-inch Flange Width

5a - 8-inch Purlin Depth

1b - 3.5-inch Flange Width

5b - 12-inch Purlin Depth

2a - 0.061-inch Thickness

6a - 20-foot Length

2b - 0.120-inch Thickness

6b - 30-foot Length

2c - 0.082-inch Thickness

7a - 0-inch Initial Displacement

2d - 0.105-inch Thickness

7b - 2-inch Initial Displacement

3a - 0.6 K/in. Diaphragm Stiffness

8a - Axial Load Model

3b - 2.4 K/in. Diaphragm Stiffness

8b - Uplift Load Model

4a - 1.2 K-in./rad. Diaphragm Rotational Stiffness

4b - 14.4 K-in./rad. Diaphragm Rotational Stiffness



Test No.	173	174	175	176	177	178	179	180	181	182	183	184
1a												
1b	1b	1b	1b	1b	1b	1b	1b	1b	1b	1b	1b	1b
2a	2a	2a	2a	2a								
2b					2b	2b	2b	2b	2b	2b	2b	2b
2c												
2d												
3a					3a	3a	3a	3a	3a	3a	3a	3a
3b	3b	3b	3b	3b								
4a					4a	4a	4a	4a				
4b	4b	4b	4b	4b					4b	4b	4b	4b
5a	5a	5a	5a	5a	5a	5a	5a	5a	5a	5a	5a	5a
5b												
6a												
6b	6b	6b	6b	6b	6b	6b	6b	6b	6b	6b	6b	6b
7a	7a	7a			7a	7a			7a	7a		
7b			7b	7b			7b	7b			7b	7b
8a	8a		8a		8a		8a		8a		8a	
8b		8b		8b		8b		8b		8b		8b

Parameter Key:

1a - 2-inch Flange Width

5a - 8-inch Purlin Depth

1b - 3.5-inch Flange Width

5b - 12-inch Purlin Depth

2a - 0.061-inch Thickness

6a - 20-foot Length

2b - 0.120-inch Thickness

6b - 30-foot Length

2c - 0.082-inch Thickness

7a - 0-inch Initial Displacement

2d - 0.105-inch Thickness

7b - 2-inch Initial Displacement

3a - 0.6 K/in. Diaphragm Stiffness

8a - Axial Load Model

3b - 2.4 K/in. Diaphragm Stiffness

8b - Uplift Load Model

4a - 1.2 K-in./rad. Diaphragm Rotational Stiffness

4b - 14.4 K-in./rad. Diaphragm Rotational Stiffness

Test No.	185	186	187	188	189	190	191	192	193	194	195	196
1a									1a	1a	1a	1a
1b	1b	1b	1b	1b	1b	1b	1b	1b				
2a									2a	2a	2a	2a
2b	2b	2b	2b	2b	2b	2b	2b	2b				
2c												
2d												
3a									3a	3a	3a	3a
3b	3b	3b	3b	3b	3b	3b	3b	3b				
4a	4a	4a	4a	4a					4a	4a	4a	4a
4b					4b	4b	4b	4b				
5a	5a	5a	5a	5a	5a	5a	5a	5a				
5b									5b	5b	5b	5b
6a									6a	6a	6a	6a
6b	6b	6b	6b	6b	6b	6b	6b	6b				
7a	7a	7a			7a	7a			7a	7a		
7b			7b	7b			7b	7b			7b	7b
8a	8a		8a		8a		8a		8a		8a	
8b		8b		8b		8b		8b		8b		8b

Parameter Key:

1a - 2-inch Flange Width

5a - 8-inch Purlin Depth

1b - 3.5-inch Flange Width

5b - 12-inch Purlin Depth

2a - 0.061-inch Thickness

6a - 20-foot Length

2b - 0.120-inch Thickness

6b - 30-foot Length

2c - 0.082-inch Thickness

7a - 0-inch Initial Displacement

2d - 0.105-inch Thickness

7b - 2-inch Initial Displacement

3a - 0.6 K/in. Diaphragm Stiffness

8a - Axial Load Model

3b - 2.4 K/in. Diaphragm Stiffness

8b - Uplift Load Model

4a - 1.2 K-in./rad. Diaphragm Rotational Stiffness

4b - 14.4 K-in./rad. Diaphragm Rotational Stiffness

Test No.	197	198	199	200	201	202	203	204	205	206	207	208
1a	1a	1a	1a	1a	1a	1a	1a	1a	1a	1a	1a	1a
1b												
2a	2a	2a	2a	2a	2a	2a	2a	2a	2a	2a	2a	2a
2b												
2c												
2d												
3a	3a	3a	3a	3a	3a	3a	3a	3a	3a	3a	3a	3a
3b												
4a	4a	4a	4a	4a								
4b					4b	4b	4b	4b	4b	4b	4b	4b
5a												
5b	5b	5b	5b	5b	5b	5b	5b	5b	5b	5b	5b	5b
6a					6a	6a	6a	6a				
6b	6b	6b	6b	6b					6b	6b	6b	6b
7a	7a	7a			7a	7a			7a	7a		
7b			7b	7b			7b	7b			7b	7b
8a	8a		8a		8a		8a		8a		8a	
8b		8b		8b		8b		8b		8b		8b

Parameter Key:

1a - 2-inch Flange Width

5a - 8-inch Purlin Depth

1b - 3.5-inch Flange Width

5b - 12-inch Purlin Depth

2a - 0.061-inch Thickness

6a - 20-foot Length

2b - 0.120-inch Thickness

6b - 30-foot Length

2c - 0.082-inch Thickness

7a - 0-inch Initial Displacement

2d - 0.105-inch Thickness

7b - 2-inch Initial Displacement

3a - 0.6 K/in. Diaphragm Stiffness

8a - Axial Load Model

3b - 2.4 K/in. Diaphragm Stiffness

8b - Uplift Load Model

4a - 1.2 K-in./rad. Diaphragm Rotational Stiffness

4b - 14.4 K-in./rad. Diaphragm Rotational Stiffness

Test No.	209	210	211	212	213	214	215	216	217	218	219	220
1a	1a	1a	1a	1a	1a	1a	1a	1a	1a	1a	1a	1a
1b												
2a	2a	2a	2a	2a	2a	2a	2a	2a	2a	2a	2a	2a
2b												
2c												
2d												
3a												
3b	3b	3b	3b	3b	3b	3b	3b	3b	3b	3b	3b	3b
4a	4a	4a	4a	4a	4a	4a	4a	4a				
4b									4b	4b	4b	4b
5a												
5b	5b	5b	5b	5b	5b	5b	5b	5b	5b	5b	5b	5b
6a	6a	6a	6a	6a					6a	6a	6a	6a
6b					6b	6b	6b	6b				
7a	7a	7a			7a	7a			7a	7a		
7b			7b	7b			7b	7b			7b	7b
8a	8a		8a		8a		8a		8a		8a	
8b		8b		8b		8b		8b		8b		8b

Parameter Key:

1a - 2-inch Flange Width

1b - 3.5-inch Flange Width

2a - 0.061-inch Thickness

2b - 0.120-inch Thickness

2c - 0.082-inch Thickness

2d - 0.105-inch Thickness

3a - 0.6 K/in. Diaphragm Stiffness

3b - 2.4 K/in. Diaphragm Stiffness

4a - 1.2 K-in./rad. Diaphragm Rotational Stiffness

4b - 14.4 K-in./rad. Diaphragm Rotational Stiffness

5a - 8-inch Purlin Depth

5b - 12-inch Purlin Depth

6a - 20-foot Length

6b - 30-foot Length

7a - 0-inch Initial Displacement

7b - 2-inch Initial Displacement

8a - Axial Load Model

8b - Uplift Load Model

Test No.	221	222	223	224	225	226	227	228	229	230	231	232
1a	1a	1a	1a	1a	1a	1a	1a	1a	1a	1a	1a	1a
1b												
2a	2a	2a	2a	2a								
2b					2b	2b	2b	2b	2b	2b	2b	2b
2c												
2d												
3a					3a	3a	3a	3a	3a	3a	3a	3a
3b	3b	3b	3b	3b								
4a					4a	4a	4a	4a	4a	4a	4a	4a
4b	4b	4b	4b	4b								
5a												
5b	5b	5b	5b	5b	5b	5b	5b	5b	5b	5b	5b	5b
6a					6a	6a	6a	6a				
6b	6b	6b	6b	6b					6b	6b	6b	6b
7a	7a	7a			7a	7a			7a	7a		
7b			7b	7b			7b	7b			7b	7b
8a	8a		8a		8a		8a		8a		8a	
8b		8b		8b		8b		8b		8b		8b

Parameter Key:

1a - 2-inch Flange Width

5a - 8-inch Purlin Depth

1b - 3.5-inch Flange Width

5b - 12-inch Purlin Depth

2a - 0.061-inch Thickness

6a - 20-foot Length

2b - 0.120-inch Thickness

6b - 30-foot Length

2c - 0.082-inch Thickness

7a - 0-inch Initial Displacement

2d - 0.105-inch Thickness

7b - 2-inch Initial Displacement

3a - 0.6 K/in. Diaphragm Stiffness

8a - Axial Load Model

3b - 2.4 K/in. Diaphragm Stiffness

8b - Uplift Load Model

4a - 1.2 K-in./rad. Diaphragm Rotational Stiffness

4b - 14.4 K-in./rad. Diaphragm Rotational Stiffness

Test No.	233	234	235	236	237	238	239	240	241	242	243	244
1a	1a	1a	1a	1a	1a	1a	1a	1a	1a	1a	1a	1a
1b												
2a												
2b	2b	2b	2b	2b	2b	2b	2b	2b	2b	2b	2b	2b
2c												
2d												
3a	3a	3a	3a	3a	3a	3a	3a	3a				
3b									3b	3b	3b	3b
4a									4a	4a	4a	4a
4b	4b	4b	4b	4b	4b	4b	4b	4b				
5a												
5b	5b	5b	5b	5b	5b	5b	5b	5b	5b	5b	5b	5b
6a	6a	6a	6a	6a					6a	6a	6a	6a
6b					6b	6b	6b	6b				
7a	7a	7a			7a	7a			7a	7a		
7b			7b	7b			7b	7b			7b	7b
8a	8a		8a		8a		8a		8a		8a	
8b		8b		8b		8b		8b		8b		8b

Parameter Key:

1a - 2-inch Flange Width

5a - 8-inch Purlin Depth

1b - 3.5-inch Flange Width

5b - 12-inch Purlin Depth

2a - 0.061-inch Thickness

6a - 20-foot Length

2b - 0.120-inch Thickness

6b - 30-foot Length

2c - 0.082-inch Thickness

7a - 0-inch Initial Displacement

2d - 0.105-inch Thickness

7b - 2-inch Initial Displacement

3a - 0.6 K/in. Diaphragm Stiffness

8a - Axial Load Model

3b - 2.4 K/in. Diaphragm Stiffness

8b - Uplift Load Model

4a - 1.2 K-in./rad. Diaphragm Rotational Stiffness

4b - 14.4 K-in./rad. Diaphragm Rotational Stiffness

Test No.	245	246	247	248	249	250	251	252	253	254	255	256
1a	1a	1a	1a	1a	1a	1a	1a	1a	1a	1a	1a	1a
1b												
2a												
2b	2b	2b	2b	2b	2b	2b	2b	2b	2b	2b	2b	2b
2c												
2d												
3a												
3b	3b	3b	3b	3b	3b	3b	3b	3b	3b	3b	3b	3b
4a	4a	4a	4a	4a								
4b					4b	4b	4b	4b	4b	4b	4b	4b
5a												
5b	5b	5b	5b	5b	5b	5b	5b	5b	5b	5b	5b	5b
6a					6a	6a	6a	6a				
6b	6b	6b	6b	6b					6b	6b	6b	6b
7a	7a	7a			7a	7a			7a	7a		
7b			7b	7b			7b	7b			7b	7b
8a	8a		8a		8a		8a		8a		8a	
8b		8b		8b		8b		8b		8b		8b

Parameter Key:

1a - 2-inch Flange Width

5a - 8-inch Purlin Depth

1b - 3.5-inch Flange Width

5b - 12-inch Purlin Depth

2a - 0.061-inch Thickness

6a - 20-foot Length

2b - 0.120-inch Thickness

6b - 30-foot Length

2c - 0.082-inch Thickness

7a - 0-inch Initial Displacement

2d - 0.105-inch Thickness

7b - 2-inch Initial Displacement

3a - 0.6 K/in. Diaphragm Stiffness

8a - Axial Load Model

3b - 2.4 K/in. Diaphragm Stiffness

8b - Uplift Load Model

4a - 1.2 K-in./rad. Diaphragm Rotational Stiffness

4b - 14.4 K-in./rad. Diaphragm Rotational Stiffness

Test No.	257	258	259	260	261	262	263	264	265	266	267	268
1a												
1b	1b	1b	1b	1b	1b	1b	1b	1b	1b	1b	1b	1b
2a	2a	2a	2a	2a	2a	2a	2a	2a	2a	2a	2a	2a
2b												
2c												
2d												
3a	3a	3a	3a	3a	3a	3a	3a	3a	3a	3a	3a	3a
3b												
4a	4a	4a	4a	4a	4a	4a	4a	4a				
4b									4b	4b	4b	4b
5a												
5b	5b	5b	5b	5b	5b	5b	5b	5b	5b	5b	5b	5b
6a	6a	6a	6a	6a					6a	6a	6a	6a
6b					6b	6b	6b	6b				
7a	7a	7a			7a	7a			7a	7a		
7b			7b	7b			7b	7b			7b	7b
8a	8a		8a		8a		8a		8a		8a	
8b		8b		8b		8b		8b		8b		8b

Parameter Key:

1a - 2-inch Flange Width

5a - 8-inch Purlin Depth

1b - 3.5-inch Flange Width

5b - 12-inch Purlin Depth

2a - 0.061-inch Thickness

6a - 20-foot Length

2b - 0.120-inch Thickness

6b - 30-foot Length

2c - 0.082-inch Thickness

7a - 0-inch Initial Displacement

2d - 0.105-inch Thickness

7b - 2-inch Initial Displacement

3a - 0.6 K/in. Diaphragm Stiffness

8a - Axial Load Model

3b - 2.4 K/in. Diaphragm Stiffness

8b - Uplift Load Model

4a - 1.2 K-in./rad. Diaphragm Rotational Stiffness

4b - 14.4 K-in./rad. Diaphragm Rotational Stiffness



Test No.	269	270	271	272	273	274	275	276	277	278	279	280
1a												
1b	1b	1b	1b	1b	1b	1b	1b	1b	1b	1b	1b	1b
2a	2a	2a	2a	2a	2a	2a	2a	2a	2a	2a	2a	2a
2b												
2c												
2d												
3a	3a	3a	3a	3a								
3b					3b	3b	3b	3b	3b	3b	3b	3b
4a					4a	4a	4a	4a	4a	4a	4a	4a
4b	4b	4b	4b	4b								
5a												
5b	5b	5b	5b	5b	5b	5b	5b	5b	5b	5b	5b	5b
6a					6a	6a	6a	6a				
6b	6b	6b	6b	6b					6b	6b	6b	6b
7a	7a	7a			7a	7a			7a	7a		
7b			7b	7b			7b	7b			7b	7b
8a	8a		8a		8a		8a		8a		8a	
8b		8b		8b		8b		8b		8b		8b

Parameter Key:

1a - 2-inch Flange Width

5a - 8-inch Purlin Depth

1b - 3.5-inch Flange Width

5b - 12-inch Purlin Depth

2a - 0.061-inch Thickness

6a - 20-foot Length

2b - 0.120-inch Thickness

6b - 30-foot Length

2c - 0.082-inch Thickness

7a - 0-inch Initial Displacement

2d - 0.105-inch Thickness

7b - 2-inch Initial Displacement

3a - 0.6 K/in. Diaphragm Stiffness

8a - Axial Load Model

3b - 2.4 K/in. Diaphragm Stiffness

8b - Uplift Load Model

4a - 1.2 K-in./rad. Diaphragm Rotational Stiffness

4b - 14.4 K-in./rad. Diaphragm Rotational Stiffness

Test No.	281	282	283	284	285	286	287	288	289	290	291	292
1a												
1b	1b	1b	1b	1b	1b	1b	1b	1b	1b	1b	1b	1b
2a	2a	2a	2a	2a	2a	2a	2a	2a				
2b									2b	2b	2b	2b
2c												
2d												
3a									3a	3a	3a	3a
3b	3b	3b	3b	3b	3b	3b	3b	3b				
4a									4a	4a	4a	4a
4b	4b	4b	4b	4b	4b	4b	4b	4b				
5a												
5b	5b	5b	5b	5b	5b	5b	5b	5b	5b	5b	5b	5b
6a	6a	6a	6a	6a					6a	6a	6a	6a
6b					6b	6b	6b	6b				
7a	7a	7a			7a	7a			7a	7a		
7b			7b	7b			7b	7b			7b	7b
8a	8a		8a		8a		8a		8a		8a	
8b		8b		8b		8b		8b		8b		8b

Parameter Key:

1a - 2-inch Flange Width

5a - 8-inch Purlin Depth

1b - 3.5-inch Flange Width

5b - 12-inch Purlin Depth

2a - 0.061-inch Thickness

6a - 20-foot Length

2b - 0.120-inch Thickness

6b - 30-foot Length

2c - 0.082-inch Thickness

7a - 0-inch Initial Displacement

2d - 0.105-inch Thickness

7b - 2-inch Initial Displacement

3a - 0.6 K/in. Diaphragm Stiffness

8a - Axial Load Model

3b - 2.4 K/in. Diaphragm Stiffness

8b - Uplift Load Model

4a - 1.2 K-in./rad. Diaphragm Rotational Stiffness

4b - 14.4 K-in./rad. Diaphragm Rotational Stiffness

Test No.	293	294	295	296	297	298	299	300	301	302	303	304
1a												
1b	1b	1b	1b	1b	1b	1b	1b	1b	1b	1b	1b	1b
2a												
2b	2b	2b	2b	2b	2b	2b	2b	2b	2b	2b	2b	2b
2c												
2d												
3a	3a	3a	3a	3a	3a	3a	3a	3a	3a	3a	3a	3a
3b												
4a	4a	4a	4a	4a								
4b					4b	4b	4b	4b	4b	4b	4b	4b
5a												
5b	5b	5b	5b	5b	5b	5b	5b	5b	5b	5b	5b	5b
6a					6a	6a	6a	6a				
6b	6b	6b	6b	6b					6b	6b	6b	6b
7a	7a	7a			7a	7a			7a	7a		
7b			7b	7b			7b	7b			7b	7b
8a	8a		8a		8a		8a		8a		8a	
8b		8b		8b		8b		8b		8b		8b

Parameter Key:

1a - 2-inch Flange Width

5a - 8-inch Purlin Depth

1b - 3.5-inch Flange Width

5b - 12-inch Purlin Depth

2a - 0.061-inch Thickness

6a - 20-foot Length

2b - 0.120-inch Thickness

6b - 30-foot Length

2c - 0.082-inch Thickness

7a - 0-inch Initial Displacement

2d - 0.105-inch Thickness

7b - 2-inch Initial Displacement

3a - 0.6 K/in. Diaphragm Stiffness

8a - Axial Load Model

3b - 2.4 K/in. Diaphragm Stiffness

8b - Uplift Load Model

4a - 1.2 K-in./rad. Diaphragm Rotational Stiffness

4b - 14.4 K-in./rad. Diaphragm Rotational Stiffness

Test No.	305	306	307	308	309	310	311	312	313	314	315	316
1a												
1b	1b	1b	1b	1b	1b	1b	1b	1b	1b	1b	1b	1b
2a												
2b	2b	2b	2b	2b	2b	2b	2b	2b	2b	2b	2b	2b
2c												
2d												
3a												
3b	3b	3b	3b	3b	3b	3b	3b	3b	3b	3b	3b	3b
4a	4a	4a	4a	4a	4a	4a	4a	4a				
4b									4b	4b	4b	4b
5a												
5b	5b	5b	5b	5b	5b	5b	5b	5b	5b	5b	5b	5b
6a	6a	6a	6a	6a					6a	6a	6a	6a
6b					6b	6b	6b	6b				
7a	7a	7a			7a	7a			7a	7a		
7b			7b	7b			7b	7b			7b	7b
8a	8a		8a		8a		8a		8a		8a	
8b		8b		8b		8b		8b		8b		8b

Parameter Key:

1a - 2-inch Flange Width

5a - 8-inch Purlin Depth

1b - 3.5-inch Flange Width

5b - 12-inch Purlin Depth

2a - 0.061-inch Thickness

6a - 20-foot Length

2b - 0.120-inch Thickness

6b - 30-foot Length

2c - 0.082-inch Thickness

7a - 0-inch Initial Displacement

2d - 0.105-inch Thickness

7b - 2-inch Initial Displacement

3a - 0.6 K/in. Diaphragm Stiffness

8a - Axial Load Model

3b - 2.4 K/in. Diaphragm Stiffness

8b - Uplift Load Model

4a - 1.2 K-in./rad. Diaphragm Rotational Stiffness

4b - 14.4 K-in./rad. Diaphragm Rotational Stiffness

Test No.	317	318	319	320	321	322	323	324	325	326	327	328
1a					1a	1a	1a	1a	1a	1a	1a	1a
1b	1b	1b	1b	1b								
2a												
2b	2b	2b	2b	2b								
2c					2c	2c	2c	2c	2c	2c	2c	2c
2d												
3a					3a	3a	3a	3a	3a	3a	3a	3a
3b	3b	3b	3b	3b								
4a					4a	4a	4a	4a	4a	4a	4a	4a
4b	4b	4b	4b	4b								
5a					5a	5a	5a	5a	5a	5a	5a	5a
5b	5b	5b	5b	5b								
6a					6a	6a	6a	6a				
6b	6b	6b	6b	6b					6b	6b	6b	6b
7a	7a	7a			7a	7a			7a	7a		
7b			7b	7b			7b	7b			7b	7b
8a	8a		8a		8a		8a		8a		8a	
8b		8b		8b		8b		8b		8b		8b

Parameter Key:

1a - 2-inch Flange Width

5a - 8-inch Purlin Depth

1b - 3.5-inch Flange Width

5b - 12-inch Purlin Depth

2a - 0.061-inch Thickness

6a - 20-foot Length

2b - 0.120-inch Thickness

6b - 30-foot Length

2c - 0.082-inch Thickness

7a - 0-inch Initial Displacement

2d - 0.105-inch Thickness

7b - 2-inch Initial Displacement

3a - 0.6 K/in. Diaphragm Stiffness

8a - Axial Load Model

3b - 2.4 K/in. Diaphragm Stiffness

8b - Uplift Load Model

4a - 1.2 K-in./rad. Diaphragm Rotational Stiffness

4b - 14.4 K-in./rad. Diaphragm Rotational Stiffness

Test No.	329	330	331	332	333	334	335	336	337	338	339	340
1a	1a	1a	1a	1a	1a	1a	1a	1a	1a	1a	1a	1a
1b												
2a												
2b												
2c	2c	2c	2c	2c	2c	2c	2c	2c	2c	2c	2c	2c
2d												
3a	3a	3a	3a	3a	3a	3a	3a	3a				
3b									3b	3b	3b	3b
4a									4a	4a	4a	4a
4b	4b	4b	4b	4b	4b	4b	4b	4b				
5a	5a	5a	5a	5a	5a	5a	5a	5a	5a	5a	5a	5a
5b												
6a	6a	6a	6a	6a					6a	6a	6a	6a
6b					6b	6b	6b	6b				
7a	7a	7a			7a	7a			7a	7a		
7b			7b	7b			7b	7b			7b	7b
8a	8a		8a		8a		8a		8a		8a	
8b		8b		8b		8b		8b		8b		8b

Parameter Key:

1a - 2-inch Flange Width

1b - 3.5-inch Flange Width

2a - 0.061-inch Thickness

2b - 0.120-inch Thickness

2c - 0.082-inch Thickness

2d - 0.105-inch Thickness

3a - 0.6 K/in. Diaphragm Stiffness

3b - 2.4 K/in. Diaphragm Stiffness

4a - 1.2 K-in./rad. Diaphragm Rotational Stiffness

4b - 14.4 K-in./rad. Diaphragm Rotational Stiffness

5a - 8-inch Purlin Depth

5b - 12-inch Purlin Depth

6a - 20-foot Length

6b - 30-foot Length

7a - 0-inch Initial Displacement

7b - 2-inch Initial Displacement

8a - Axial Load Model

8b - Uplift Load Model

Test No.	341	342	343	344	345	346	347	348	349	350	351	352
1a	1a	1a	1a	1a	1a	1a	1a	1a	1a	1a	1a	1a
1b												
2a												
2b												
2c	2c	2c	2c	2c	2c	2c	2c	2c	2c	2c	2c	2c
2d												
3a												
3b	3b	3b	3b	3b	3b	3b	3b	3b	3b	3b	3b	3b
4a	4a	4a	4a	4a								
4b					4b	4b	4b	4b	4b	4b	4b	4b
5a	5a	5a	5a	5a	5a	5a	5a	5a	5a	5a	5a	5a
5b												
6a					6a	6a	6a	6a				
6b	6b	6b	6b	6b					6b	6b	6b	6b
7a	7a	7a			7a	7a			7a	7a		
7b			7b	7b			7b	7b			7b	7b
8a	8a		8a		8a		8a		8a		8a	
8b		8b		8b		8b		8b		8b		8b

Parameter Key:

1a - 2-inch Flange Width

5a - 8-inch Purlin Depth

1b - 3.5-inch Flange Width

5b - 12-inch Purlin Depth

2a - 0.061-inch Thickness

6a - 20-foot Length

2b - 0.120-inch Thickness

6b - 30-foot Length

2c - 0.082-inch Thickness

7a - 0-inch Initial Displacement

2d - 0.105-inch Thickness

7b - 2-inch Initial Displacement

3a - 0.6 K/in. Diaphragm Stiffness

8a - Axial Load Model

3b - 2.4 K/in. Diaphragm Stiffness

8b - Uplift Load Model

4a - 1.2 K-in./rad. Diaphragm Rotational Stiffness

4b - 14.4 K-in./rad. Diaphragm Rotational Stiffness

Test No.	353	354	355	356	357	358	359	360	361	362	363	364
1a	1a	1a	1a	1a	1a	1a	1a	1a	1a	1a	1a	1a
1b												
2a												
2b												
2c												
2d	2d	2d	2d	2d	2d	2d	2d	2d	2d	2d	2d	2d
3a	3a	3a	3a	3a	3a	3a	3a	3a	3a	3a	3a	3a
3b												
4a	4a	4a	4a	4a	4a	4a	4a	4a				
4b									4b	4b	4b	4b
5a	5a	5a	5a	5a	5a	5a	5a	5a	5a	5a	5a	5a
5b												
6a	6a	6a	6a	6a					6a	6a	6a	6a
6b					6b	6b	6b	6b				
7a	7a	7a			7a	7a			7a	7a		
7b			7b	7b			7b	7b			7b	7b
8a	8a		8a		8a		8a		8a		8a	
8b		8b		8b		8b		8b		8b		8b

Parameter Key:

1a - 2-inch Flange Width

5a - 8-inch Purlin Depth

1b - 3.5-inch Flange Width

5b - 12-inch Purlin Depth

2a - 0.061-inch Thickness

6a - 20-foot Length

2b - 0.120-inch Thickness

6b - 30-foot Length

2c - 0.082-inch Thickness

7a - 0-inch Initial Displacement

2d - 0.105-inch Thickness

7b - 2-inch Initial Displacement

3a - 0.6 K/in. Diaphragm Stiffness

8a - Axial Load Model

3b - 2.4 K/in. Diaphragm Stiffness

8b - Uplift Load Model

4a - 1.2 K-in./rad. Diaphragm Rotational Stiffness

4b - 14.4 K-in./rad. Diaphragm Rotational Stiffness



Test No.	365	366	367	368	369	370	371	372	373	374	375	376
1a	1a	1a	1a	1a	1a	1a	1a	1a	1a	1a	1a	1a
1b												
2a												
2b												
2c												
2d	2d	2d	2d	2d	2d	2d	2d	2d	2d	2d	2d	2d
3a	3a	3a	3a	3a								
3b					3b	3b	3b	3b	3b	3b	3b	3b
4a					4a	4a	4a	4a	4a	4a	4a	4a
4b	4b	4b	4b	4b								
5a	5a	5a	5a	5a	5a	5a	5a	5a	5a	5a	5a	5a
5b												
6a					6a	6a	6a	6a				
6b	6b	6b	6b	6b					6b	6b	6b	6b
7a	7a	7a			7a	7a			7a	7a		
7b			7b	7b			7b	7b			7b	7b
8a	8a		8a		8a		8a		8a		8a	
8b		8b		8b		8b		8b		8b		8b

Parameter Key:

1a - 2-inch Flange Width

1b - 3.5-inch Flange Width

2a - 0.061-inch Thickness

2b - 0.120-inch Thickness

2c - 0.082-inch Thickness

2d - 0.105-inch Thickness

3a - 0.6 K/in. Diaphragm Stiffness

3b - 2.4 K/in. Diaphragm Stiffness

4a - 1.2 K-in./rad. Diaphragm Rotational Stiffness

4b - 14.4 K-in./rad. Diaphragm Rotational Stiffness

5a - 8-inch Purlin Depth

5b - 12-inch Purlin Depth

6a - 20-foot Length

6b - 30-foot Length

7a - 0-inch Initial Displacement

7b - 2-inch Initial Displacement

8a - Axial Load Model

8b - Uplift Load Model

Test No.	377	378	379	380	381	382	383	384	385	386	387	388
1a	1a	1a	1a	1a	1a	1a	1a	1a				
1b									1b	1b	1b	1b
2a												
2b												
2c									2c	2c	2c	2c
2d	2d	2d	2d	2d	2d	2d	2d	2d				
3a									3a	3a	3a	3a
3b	3b	3b	3b	3b	3b	3b	3b	3b				
4a									4a	4a	4a	4a
4b	4b	4b	4b	4b	4b	4b	4b	4b				
5a	5a	5a	5a	5a	5a	5a	5a	5a	5a	5a	5a	
5b												
6a	6a	6a	6a	6a					6a	6a	6a	
6b					6b	6b	6b	6b				
7a	7a	7a			7a	7a			7a	7a		
7b			7b	7b			7b	7b			7b	7b
8a	8a		8a		8a		8a		8a		8a	
8b		8b		8b		8b		8b		8b		8b

Parameter Key:

1a - 2-inch Flange Width

1b - 3.5-inch Flange Width

2a - 0.061-inch Thickness

2b - 0.120-inch Thickness

2c - 0.082-inch Thickness

2d - 0.105-inch Thickness

3a - 0.6 K/in. Diaphragm Stiffness

3b - 2.4 K/in. Diaphragm Stiffness

4a - 1.2 K-in./rad. Diaphragm Rotational Stiffness

4b - 14.4 K-in./rad. Diaphragm Rotational Stiffness

5a - 8-inch Purlin Depth

5b - 12-inch Purlin Depth

6a - 20-foot Length

6b - 30-foot Length

7a - 0-inch Initial Displacement

7b - 2-inch Initial Displacement

8a - Axial Load Model

8b - Uplift Load Model

Test No.	389	390	391	392	393	394	395	396	397	398	399	400
1a												
1b	1b	1b	1b	1b	1b	1b	1b	1b	1b	1b	1b	1b
2a												
2b												
2c	2c	2c	2c	2c	2c	2c	2c	2c	2c	2c	2c	2c
2d												
3a	3a	3a	3a	3a	3a	3a	3a	3a	3a	3a	3a	3a
3b												
4a	4a	4a	4a	4a								
4b					4b	4b	4b	4b	4b	4b	4b	4b
5a	5a	5a	5a	5a	5a	5a	5a	5a	5a	5a	5a	5a
5b												
6a					6a	6a	6a	6a				
6b	6b	6b	6b	6b					6b	6b	6b	6b
7a	7a	7a			7a	7a			7a	7a		
7b			7b	7b			7b	7b			7b	7b
8a	8a		8a		8a		8a		8a		8a	
8b		8b		8b		8b		8b		8b		8b

Parameter Key:

1a - 2-inch Flange Width

5a - 8-inch Purlin Depth

1b - 3.5-inch Flange Width

5b - 12-inch Purlin Depth

2a - 0.061-inch Thickness

6a - 20-foot Length

2b - 0.120-inch Thickness

6b - 30-foot Length

2c - 0.082-inch Thickness

7a - 0-inch Initial Displacement

2d - 0.105-inch Thickness

7b - 2-inch Initial Displacement

3a - 0.6 K/in. Diaphragm Stiffness

8a - Axial Load Model

3b - 2.4 K/in. Diaphragm Stiffness

8b - Uplift Load Model

4a - 1.2 K-in./rad. Diaphragm Rotational Stiffness

4b - 14.4 K-in./rad. Diaphragm Rotational Stiffness

Test No.	401	402	403	404	405	406	407	408	409	410	411	412
1a												
1b	1b	1b	1b	1b	1b	1b	1b	1b	1b	1b	1b	1b
2a												
2b												
2c	2c	2c	2c	2c	2c	2c	2c	2c	2c	2c	2c	2c
2d												
3a												
3b	3b	3b	3b	3b	3b	3b	3b	3b	3b	3b	3b	3b
4a	4a	4a	4a	4a	4a	4a	4a	4a				
4b									4b	4b	4b	4b
5a	5a	5a	5a	5a	5a	5a	5a	5a	5a	5a	5a	5a
5b												
6a	6a	6a	6a	6a					6a	6a	6a	6a
6b					6b	6b	6b	6b				
7a	7a	7a			7a	7a			7a	7a		
7b			7b	7b			7b	7b			7b	7b
8a	8a		8a		8a		8a		8a		8a	
8b		8b		8b		8b		8b		8b		8b

Parameter Key:

1a - 2-inch Flange Width

5a - 8-inch Purlin Depth

1b - 3.5-inch Flange Width

5b - 12-inch Purlin Depth

2a - 0.061-inch Thickness

6a - 20-foot Length

2b - 0.120-inch Thickness

6b - 30-foot Length

2c - 0.082-inch Thickness

7a - 0-inch Initial Displacement

2d - 0.105-inch Thickness

7b - 2-inch Initial Displacement

3a - 0.6 K/in. Diaphragm Stiffness

8a - Axial Load Model

3b - 2.4 K/in. Diaphragm Stiffness

8b - Uplift Load Model

4a - 1.2 K-in./rad. Diaphragm Rotational Stiffness

4b - 14.4 K-in./rad. Diaphragm Rotational Stiffness

Test No.	413	414	415	416	417	418	419	420	421	422	423	424
1a												
1b	1b	1b	1b	1b	1b	1b	1b	1b	1b	1b	1b	1b
2a												
2b												
2c	2c	2c	2c	2c								
2d					2d	2d	2d	2d	2d	2d	2d	2d
3a					3a	3a	3a	3a	3a	3a	3a	3a
3b	3b	3b	3b	3b								
4a					4a	4a	4a	4a	4a	4a	4a	4a
4b	4b	4b	4b	4b								
5a	5a	5a	5a	5a	5a	5a	5a	5a	5a	5a	5a	5a
5b												
6a					6a	6a	6a	6a				
6b	6b	6b	6b	6b					6b	6b	6b	6b
7a	7a	7a			7a	7a			7a	7a		
7b			7b	7b			7b	7b			7b	7b
8a	8a		8a		8a		8a		8a		8a	
8b		8b		8b		8b		8b		8b		8b

Parameter Key:

1a - 2-inch Flange Width

5a - 8-inch Purlin Depth

1b - 3.5-inch Flange Width

5b - 12-inch Purlin Depth

2a - 0.061-inch Thickness

6a - 20-foot Length

2b - 0.120-inch Thickness

6b - 30-foot Length

2c - 0.082-inch Thickness

7a - 0-inch Initial Displacement

2d - 0.105-inch Thickness

7b - 2-inch Initial Displacement

3a - 0.6 K/in. Diaphragm Stiffness

8a - Axial Load Model

3b - 2.4 K/in. Diaphragm Stiffness

8b - Uplift Load Model

4a - 1.2 K-in./rad. Diaphragm Rotational Stiffness

4b - 14.4 K-in./rad. Diaphragm Rotational Stiffness

Test No.	425	426	427	428	429	430	431	432	433	434	435	436
1a												
1b	1b	1b	1b	1b	1b	1b	1b	1b	1b	1b	1b	1b
2a												
2b												
2c												
2d	2d	2d	2d	2d	2d	2d	2d	2d	2d	2d	2d	2d
3a	3a	3a	3a	3a	3a	3a	3a	3a				
3b									3b	3b	3b	3b
4a									4a	4a	4a	4a
4b	4b	4b	4b	4b	4b	4b	4b	4b				
5a	5a	5a	5a	5a	5a	5a	5a	5a	5a	5a	5a	5a
5b												
6a	6a	6a	6a	6a					6a	6a	6a	6a
6b					6b	6b	6b	6b				
7a	7a	7a			7a	7a			7a	7a		
7b			7b	7b			7b	7b			7b	7b
8a	8a		8a		8a		8a		8a		8a	
8b		8b		8b		8b		8b		8b		8b

Parameter Key:

1a - 2-inch Flange Width

5a - 8-inch Purlin Depth

1b - 3.5-inch Flange Width

5b - 12-inch Purlin Depth

2a - 0.061-inch Thickness

6a - 20-foot Length

2b - 0.120-inch Thickness

6b - 30-foot Length

2c - 0.082-inch Thickness

7a - 0-inch Initial Displacement

2d - 0.105-inch Thickness

7b - 2-inch Initial Displacement

3a - 0.6 K/in. Diaphragm Stiffness

8a - Axial Load Model

3b - 2.4 K/in. Diaphragm Stiffness

8b - Uplift Load Model

4a - 1.2 K-in./rad. Diaphragm Rotational Stiffness

4b - 14.4 K-in./rad. Diaphragm Rotational Stiffness

Test No.	437	438	439	440	441	442	443	444	445	446	447	448
1a												
1b	1b	1b	1b	1b	1b	1b	1b	1b	1b	1b	1b	1b
2a												
2b												
2c												
2d	2d	2d	2d	2d	2d	2d	2d	2d	2d	2d	2d	2d
3a												
3b	3b	3b	3b	3b	3b	3b	3b	3b	3b	3b	3b	3b
4a	4a	4a	4a	4a								
4b					4b	4b	4b	4b	4b	4b	4b	4b
5a	5a	5a	5a	5a	5a	5a	5a	5a	5a	5a	5a	5a
5b												
6a					6a	6a	6a	6a				
6b	6b	6b	6b	6b					6b	6b	6b	6b
7a	7a	7a			7a	7a			7a	7a		
7b			7b	7b			7b	7b			7b	7b
8a	8a		8a		8a		8a		8a		8a	
8b		8b		8b		8b		8b		8b		8b

Parameter Key:

1a - 2-inch Flange Width

5a - 8-inch Purlin Depth

1b - 3.5-inch Flange Width

5b - 12-inch Purlin Depth

2a - 0.061-inch Thickness

6a - 20-foot Length

2b - 0.120-inch Thickness

6b - 30-foot Length

2c - 0.082-inch Thickness

7a - 0-inch Initial Displacement

2d - 0.105-inch Thickness

7b - 2-inch Initial Displacement

3a - 0.6 K/in. Diaphragm Stiffness

8a - Axial Load Model

3b - 2.4 K/in. Diaphragm Stiffness

8b - Uplift Load Model

4a - 1.2 K-in./rad. Diaphragm Rotational Stiffness

4b - 14.4 K-in./rad. Diaphragm Rotational Stiffness

Test No.	449	450	451	452	453	454	455	456	457	458	459	460
1a	1a	1a	1a	1a	1a	1a	1a	1a	1a	1a	1a	1a
1b												
2a												
2b												
2c	2c	2c	2c	2c	2c	2c	2c	2c	2c	2c	2c	2c
2d												
3a	3a	3a	3a	3a	3a	3a	3a	3a	3a	3a	3a	3a
3b												
4a	4a	4a	4a	4a	4a	4a	4a	4a				
4b									4b	4b	4b	4b
5a												
5b	5b	5b	5b	5b	5b	5b	5b	5b	5b	5b	5b	5b
6a	6a	6a	6a	6a					6a	6a	6a	6a
6b					6b	6b	6b	6b				
7a	7a	7a			7a	7a			7a	7a		
7b			7b	7b			7b	7b			7b	7b
8a	8a		8a		8a		8a		8a		8a	
8b		8b		8b		8b		8b		8b		8b

Parameter Key:

1a - 2-inch Flange Width

5a - 8-inch Purlin Depth

1b - 3.5-inch Flange Width

5b - 12-inch Purlin Depth

2a - 0.061-inch Thickness

6a - 20-foot Length

2b - 0.120-inch Thickness

6b - 30-foot Length

2c - 0.082-inch Thickness

7a - 0-inch Initial Displacement

2d - 0.105-inch Thickness

7b - 2-inch Initial Displacement

3a - 0.6 K/in. Diaphragm Stiffness

8a - Axial Load Model

3b - 2.4 K/in. Diaphragm Stiffness

8b - Uplift Load Model

4a - 1.2 K-in./rad. Diaphragm Rotational Stiffness

4b - 14.4 K-in./rad. Diaphragm Rotational Stiffness



Test No.	461	462	463	464	465	466	467	468	469	470	471	472
1a	1a	1a	1a	1a	1a	1a	1a	1a	1a	1a	1a	1a
1b												
2a												
2b												
2c	2c	2c	2c	2c	2c	2c	2c	2c	2c	2c	2c	2c
2d												
3a	3a	3a	3a	3a								
3b					3b	3b	3b	3b	3b	3b	3b	3b
4a					4a	4a	4a	4a	4a	4a	4a	4a
4b	4b	4b	4b	4b								
5a												
5b	5b	5b	5b	5b	5b	5b	5b	5b	5b	5b	5b	5b
6a					6a	6a	6a	6a				
6b	6b	6b	6b	6b					6b	6b	6b	6b
7a	7a	7a			7a	7a			7a	7a		
7b			7b	7b			7b	7b			7b	7b
8a	8a		8a		8a		8a		8a		8a	
8b		8b		8b		8b		8b		8b		8b

Parameter Key:

1a - 2-inch Flange Width

5a - 8-inch Purlin Depth

1b - 3.5-inch Flange Width

5b - 12-inch Purlin Depth

2a - 0.061-inch Thickness

6a - 20-foot Length

2b - 0.120-inch Thickness

6b - 30-foot Length

2c - 0.082-inch Thickness

7a - 0-inch Initial Displacement

2d - 0.105-inch Thickness

7b - 2-inch Initial Displacement

3a - 0.6 K/in. Diaphragm Stiffness

8a - Axial Load Model

3b - 2.4 K/in. Diaphragm Stiffness

8b - Uplift Load Model

4a - 1.2 K-in./rad. Diaphragm Rotational Stiffness

4b - 14.4 K-in./rad. Diaphragm Rotational Stiffness

Test No.	473	474	475	476	477	478	479	480	481	482	483	484
1a	1a	1a	1a	1a	1a	1a	1a	1a	1a	1a	1a	1a
1b												
2a												
2b												
2c	2c	2c	2c	2c	2c	2c	2c	2c				
2d									2d	2d	2d	2d
3a									3a	3a	3a	3a
3b	3b	3b	3b	3b	3b	3b	3b	3b				
4a									4a	4a	4a	4a
4b	4b	4b	4b	4b	4b	4b	4b	4b				
5a												
5b	5b	5b	5b	5b	5b	5b	5b	5b	5b	5b	5b	5b
6a	6a	6a	6a	6a					6a	6a	6a	6a
6b					6b	6b	6b	6b				
7a	7a	7a			7a	7a			7a	7a		
7b			7b	7b			7b	7b			7b	7b
8a	8a		8a		8a		8a		8a		8a	
8b		8b		8b		8b		8b		8b		8b

Parameter Key:

1a - 2-inch Flange Width

1b - 3.5-inch Flange Width

2a - 0.061-inch Thickness

2b - 0.120-inch Thickness

2c - 0.082-inch Thickness

2d - 0.105-inch Thickness

3a - 0.6 K/in. Diaphragm Stiffness

3b - 2.4 K/in. Diaphragm Stiffness

4a - 1.2 K-in./rad. Diaphragm Rotational Stiffness

4b - 14.4 K-in./rad. Diaphragm Rotational Stiffness

5a - 8-inch Purlin Depth

5b - 12-inch Purlin Depth

6a - 20-foot Length

6b - 30-foot Length

7a - 0-inch Initial Displacement

7b - 2-inch Initial Displacement

8a - Axial Load Model

8b - Uplift Load Model

Test No.	485	486	487	488	489	490	491	492	493	494	495	496
1a	1a	1a	1a	1a	1a	1a	1a	1a	1a	1a	1a	1a
1b												
2a												
2b												
2c												
2d	2d	2d	2d	2d	2d	2d	2d	2d	2d	2d	2d	2d
3a	3a	3a	3a	3a	3a	3a	3a	3a	3a	3a	3a	3a
3b												
4a	4a	4a	4a	4a								
4b					4b	4b	4b	4b	4b	4b	4b	4b
5a												
5b	5b	5b	5b	5b	5b	5b	5b	5b	5b	5b	5b	5b
6a					6a	6a	6a	6a				
6b	6b	6b	6b	6b					6b	6b	6b	6b
7a	7a	7a			7a	7a			7a	7a		
7b			7b	7b			7b	7b			7b	7b
8a	8a		8a		8a		8a		8a		8a	
8b		8b		8b		8b		8b		8b		8b

Parameter Key:

1a - 2-inch Flange Width

5a - 8-inch Purlin Depth

1b - 3.5-inch Flange Width

5b - 12-inch Purlin Depth

2a - 0.061-inch Thickness

6a - 20-foot Length

2b - 0.120-inch Thickness

6b - 30-foot Length

2c - 0.082-inch Thickness

7a - 0-inch Initial Displacement

2d - 0.105-inch Thickness

7b - 2-inch Initial Displacement

3a - 0.6 K/in. Diaphragm Stiffness

8a - Axial Load Model

3b - 2.4 K/in. Diaphragm Stiffness

8b - Uplift Load Model

4a - 1.2 K-in./rad. Diaphragm Rotational Stiffness

4b - 14.4 K-in./rad. Diaphragm Rotational Stiffness

Test No.	497	498	499	500	501	502	503	504	505	506	507	508
1a	1a	1a	1a	1a	1a	1a	1a	1a	1a	1a	1a	1a
1b												
2a												
2b												
2c												
2d	2d	2d	2d	2d	2d	2d	2d	2d	2d	2d	2d	2d
3a												
3b	3b	3b	3b	3b	3b	3b	3b	3b	3b	3b	3b	3b
4a	4a	4a	4a	4a	4a	4a	4a	4a				
4b									4b	4b	4b	4b
5a												
5b	5b	5b	5b	5b	5b	5b	5b	5b	5b	5b	5b	5b
6a	6a	6a	6a	6a					6a	6a	6a	6a
6b					6b	6b	6b	6b				
7a	7a	7a			7a	7a			7a	7a		
7b			7b	7b			7b	7b			7b	7b
8a	8a		8a		8a		8a		8a		8a	
8b		8b		8b		8b		8b		8b		8b

Parameter Key:

1a - 2-inch Flange Width

5a - 8-inch Purlin Depth

1b - 3.5-inch Flange Width

5b - 12-inch Purlin Depth

2a - 0.061-inch Thickness

6a - 20-foot Length

2b - 0.120-inch Thickness

6b - 30-foot Length

2c - 0.082-inch Thickness

7a - 0-inch Initial Displacement

2d - 0.105-inch Thickness

7b - 2-inch Initial Displacement

3a - 0.6 K/in. Diaphragm Stiffness

8a - Axial Load Model

3b - 2.4 K/in. Diaphragm Stiffness

8b - Uplift Load Model

4a - 1.2 K-in./rad. Diaphragm Rotational Stiffness

4b - 14.4 K-in./rad. Diaphragm Rotational Stiffness

Test No.	509	510	511	512	513	514	515	516	517	518	519	520
1a	1a	1a	1a	1a								
1b					1b	1b	1b	1b	1b	1b	1b	1b
2a												
2b												
2c					2c	2c	2c	2c	2c	2c	2c	2c
2d	2d	2d	2d	2d								
3a					3a	3a	3a	3a	3a	3a	3a	3a
3b	3b	3b	3b	3b								
4a					4a	4a	4a	4a	4a	4a	4a	4a
4b	4b	4b	4b	4b								
5a												
5b	5b	5b	5b	5b	5b	5b	5b	5b	5b	5b	5b	5b
6a					6a	6a	6a	6a				
6b	6b	6b	6b	6b					6b	6b	6b	6b
7a	7a	7a			7a	7a			7a	7a		
7b			7b	7b			7b	7b			7b	7b
8a	8a		8a		8a		8a		8a		8a	
8b		8b		8b		8b		8b		8b		8b

Parameter Key:

1a - 2-inch Flange Width

5a - 8-inch Purlin Depth

1b - 3.5-inch Flange Width

5b - 12-inch Purlin Depth

2a - 0.061-inch Thickness

6a - 20-foot Length

2b - 0.120-inch Thickness

6b - 30-foot Length

2c - 0.082-inch Thickness

7a - 0-inch Initial Displacement

2d - 0.105-inch Thickness

7b - 2-inch Initial Displacement

3a - 0.6 K/in. Diaphragm Stiffness

8a - Axial Load Model

3b - 2.4 K/in. Diaphragm Stiffness

8b - Uplift Load Model

4a - 1.2 K-in./rad. Diaphragm Rotational Stiffness

4b - 14.4 K-in./rad. Diaphragm Rotational Stiffness

Test No.	521	522	523	524	525	526	527	528	529	530	531	532
1a												
1b	1b	1b	1b	1b	1b	1b	1b	1b	1b	1b	1b	1b
2a												
2b												
2c	2c	2c	2c	2c	2c	2c	2c	2c	2c	2c	2c	2c
2d												
3a	3a	3a	3a	3a	3a	3a	3a	3a				
3b									3b	3b	3b	3b
4a									4a	4a	4a	4a
4b	4b	4b	4b	4b	4b	4b	4b	4b				
5a												
5b	5b	5b	5b	5b	5b	5b	5b	5b	5b	5b	5b	5b
6a	6a	6a	6a	6a					6a	6a	6a	6a
6b					6b	6b	6b	6b				
7a	7a	7a			7a	7a			7a	7a		
7b			7b	7b			7b	7b			7b	7b
8a	8a		8a		8a		8a		8a		8a	
8b		8b		8b		8b		8b		8b		8b

Parameter Key:

1a - 2-inch Flange Width

5a - 8-inch Purlin Depth

1b - 3.5-inch Flange Width

5b - 12-inch Purlin Depth

2a - 0.061-inch Thickness

6a - 20-foot Length

2b - 0.120-inch Thickness

6b - 30-foot Length

2c - 0.082-inch Thickness

7a - 0-inch Initial Displacement

2d - 0.105-inch Thickness

7b - 2-inch Initial Displacement

3a - 0.6 K/in. Diaphragm Stiffness

8a - Axial Load Model

3b - 2.4 K/in. Diaphragm Stiffness

8b - Uplift Load Model

4a - 1.2 K-in./rad. Diaphragm Rotational Stiffness

4b - 14.4 K-in./rad. Diaphragm Rotational Stiffness

Test No.	533	534	535	536	537	538	539	540	541	542	543	544
1a												
1b	1b	1b	1b	1b	1b	1b	1b	1b	1b	1b	1b	1b
2a												
2b												
2c	2c	2c	2c	2c	2c	2c	2c	2c	2c	2c	2c	2c
2d												
3a												
3b	3b	3b	3b	3b	3b	3b	3b	3b	3b	3b	3b	3b
4a	4a	4a	4a	4a								
4b					4b	4b	4b	4b	4b	4b	4b	4b
5a												
5b	5b	5b	5b	5b	5b	5b	5b	5b	5b	5b	5b	5b
6a					6a	6a	6a	6a				
6b	6b	6b	6b	6b					6b	6b	6b	6b
7a	7a	7a			7a	7a			7a	7a		
7b			7b	7b			7b	7b			7b	7b
8a	8a		8a		8a		8a		8a		8a	
8b		8b		8b		8b		8b		8b		8b

Parameter Key:

1a - 2-inch Flange Width

5a - 8-inch Purlin Depth

1b - 3.5-inch Flange Width

5b - 12-inch Purlin Depth

2a - 0.061-inch Thickness

6a - 20-foot Length

2b - 0.120-inch Thickness

6b - 30-foot Length

2c - 0.082-inch Thickness

7a - 0-inch Initial Displacement

2d - 0.105-inch Thickness

7b - 2-inch Initial Displacement

3a - 0.6 K/in. Diaphragm Stiffness

8a - Axial Load Model

3b - 2.4 K/in. Diaphragm Stiffness

8b - Uplift Load Model

4a - 1.2 K-in./rad. Diaphragm Rotational Stiffness

4b - 14.4 K-in./rad. Diaphragm Rotational Stiffness

Test No.	545	546	547	548	549	550	551	552	553	554	555	556
1a												
1b	1b	1b	1b	1b	1b	1b	1b	1b	1b	1b	1b	1b
2a												
2b												
2c												
2d	2d	2d	2d	2d	2d	2d	2d	2d	2d	2d	2d	2d
3a	3a	3a	3a	3a	3a	3a	3a	3a	3a	3a	3a	3a
3b												
4a	4a	4a	4a	4a	4a	4a	4a	4a				
4b												
5a												
5b	5b	5b	5b	5b	5b	5b	5b	5b	5b	5b	5b	5b
6a	6a	6a	6a	6a					6a	6a	6a	6a
6b					6b	6b	6b	6b				
7a	7a	7a			7a	7a			7a	7a		
7b			7b	7b			7b	7b			7b	7b
8a	8a		8a		8a		8a		8a		8a	
8b		8b		8b		8b		8b		8b		8b

Parameter Key:

1a - 2-inch Flange Width

5a - 8-inch Purlin Depth

1b - 3.5-inch Flange Width

5b - 12-inch Purlin Depth

2a - 0.061-inch Thickness

6a - 20-foot Length

2b - 0.120-inch Thickness

6b - 30-foot Length

2c - 0.082-inch Thickness

7a - 0-inch Initial Displacement

2d - 0.105-inch Thickness

7b - 2-inch Initial Displacement

3a - 0.6 K/in. Diaphragm Stiffness

8a - Axial Load Model

3b - 2.4 K/in. Diaphragm Stiffness

8b - Uplift Load Model

4a - 1.2 K-in./rad. Diaphragm Rotational Stiffness

4b - 14.4 K-in./rad. Diaphragm Rotational Stiffness



Test No.	557	558	559	560	561	562	563	564	565	566	567	568
1a												
1b	1b	1b	1b	1b	1b	1b	1b	1b	1b	1b	1b	1b
2a												
2b												
2c												
2d	2d	2d	2d	2d	2d	2d	2d	2d	2d	2d	2d	2d
3a	3a	3a	3a	3a								
3b					3b	3b	3b	3b	3b	3b	3b	3b
4a					4a	4a	4a	4a	4a	4a	4a	4a
4b	4b	4b	4b	4b								
5a												
5b	5b	5b	5b	5b	5b	5b	5b	5b	5b	5b	5b	5b
6a					6a	6a	6a	6a				
6b	6b	6b	6b	6b					6b	6b	6b	6b
7a	7a	7a			7a	7a			7a	7a		
7b			7b	7b			7b	7b			7b	7b
8a	8a		8a		8a		8a		8a		8a	
8b		8b		8b		8b		8b		8b		8b

Parameter Key:

1a - 2-inch Flange Width

5a - 8-inch Purlin Depth

1b - 3.5-inch Flange Width

5b - 12-inch Purlin Depth

2a - 0.061-inch Thickness

6a - 20-foot Length

2b - 0.120-inch Thickness

6b - 30-foot Length

2c - 0.082-inch Thickness

7a - 0-inch Initial Displacement

2d - 0.105-inch Thickness

7b - 2-inch Initial Displacement

3a - 0.6 K/in. Diaphragm Stiffness

8a - Axial Load Model

3b - 2.4 K/in. Diaphragm Stiffness

8b - Uplift Load Model

4a - 1.2 K-in./rad. Diaphragm Rotational Stiffness

4b - 14.4 K-in./rad. Diaphragm Rotational Stiffness

Test No.	569	570	571	572	573	574	575	576
1a								
1b	1b	1b	1b	1b	1b	1b	1b	1b
2a								
2b								
2c								
2d	2d	2d	2d	2d	2d	2d	2d	2d
3a								
3b	3b	3b	3b	3b	3b	3b	3b	3b
4a								
4b	4b	4b	4b	4b	4b	4b	4b	4b
5a								
5b	5b	5b	5b	5b	5b	5b	5b	5b
6a	6a	6a	6a	6a				
6b					6b	6b	6b	6b
7a	7a	7a			7a	7a		
7b			7b	7b			7b	7b
8a	8a		8a		8a		8a	
8b		8b		8b		8b		8b

Parameter Key:

1a - 2-inch Flange Width

5a - 8-inch Purlin Depth

1b - 3.5-inch Flange Width

5b - 12-inch Purlin Depth

2a - 0.061-inch Thickness

6a - 20-foot Length

2b - 0.120-inch Thickness

6b - 30-foot Length

2c - 0.082-inch Thickness

7a - 0-inch Initial Displacement

2d - 0.105-inch Thickness

7b - 2-inch Initial Displacement

3a - 0.6 K/in. Diaphragm Stiffness

8a - Axial Load Model

3b - 2.4 K/in. Diaphragm Stiffness

8b - Uplift Load Model

4a - 1.2 K-in./rad. Diaphragm Rotational Stiffness

4b - 14.4 K-in./rad. Diaphragm Rotational Stiffness

**APPENDIX 2: FINITE ELEMENT MODEL TEST RESULTS**

0.061 x 2 x 8 Z-Purlin						
Test No.	Buckling Load, K	Elastic Stress		k <sub>af</sub>		Failure Mode
		Axial, ksi	Flexural, ksi			
1	7.436	9.171		0.290		1
2	1.973*		31.584			2
3	6.192	7.638		0.244		1
4	1.952*		31.248			1
9	7.436	9.172		0.236		1
10	2.432*		38.921			2
11	6.528	8.052		0.237		1
12	2.119*		33.910			1
17	7.436	9.171		0.269		1
18	2.127*		34.037			2
19	6.221	7.672		0.241		1
20	1.988*		31.822			1
25	7.436	9.172		0.217		1
26	2.639*		42.242			2
27	6.545	8.072		0.234		1
28	2.156*		34.508			1

\* Total flexural uplift load, W

0.120 x 2 x 8 Z-Purlin						
Test No.	Buckling Load, K	Elastic Stress		$k_{af}$		Failure Mode
		Axial, ksi	Flexural, ksi			
33	20.378	12.974		0.419		2
34	3.679*		30.996			2
35	19.388	12.344		0.406		2
36	3.607*		30.390			2
41	28.335	18.040		0.355		2
42	6.029*		50.805			2
43	26.852	17.096		0.336		2
44	6.030*		50.812			2
49	26.868	17.106		0.485		2
50	4.186*		35.270			2
51	25.090	15.974		0.466		2
52	4.070*		34.294			2
57	46.304	29.480		0.515		7
58	6.798*		57.281			3
59	40.830	25.995		0.452		8
60	6.832*		57.569			3

\* Total flexural uplift load, W

<b>0.061 x 3.5 x 8 Z-Purlin</b>						
Test No.	Buckling Load, K	Elastic Stress		$k_{af}$		Failure Mode
		Axial, ksi	Flexural, ksi			
65	8.662	8.716		0.264		1
66	2.857*		33.026			6
67	7.217	7.262		0.282		1
68	2.231*		25.787			1
73	8.663	8.717		0.249		1
74	3.034*		35.076			1
75	7.393	7.440		0.289		1
76	2.230*		25.778			1
81	8.662	8.716		0.296		1
82	2.549*		29.468			6
83	7.249	7.294		0.269		1
84	2.347*		27.129			1
89	8.662	8.717		0.281		1
90	2.684*		31.031			6
91	7.415	7.461		0.275		1
92	2.348*		27.141			1

\* Total flexural uplift load, W

<b>0.120 x 3.5 x 8 Z-Purlin</b>						
Test No.	Buckling Load, K	Elastic Stress		$k_{af}$		Failure Mode
		Axial, ksi	Flexural, ksi			
97	30.821	15.964		0.338		2
98	7.809*		47.257			2
99	29.394	15.224		0.326		2
100	7.725*		46.746			2
105	33.607	17.407		0.291		2
106	9.889*		59.839			2
107	32.446	16.805		0.280		2
108	9.914*		59.995			2
113	47.781	24.748		0.447		2
114	9.139*		55.305			2
115	42.595	22.062		0.409		2
116	8.922*		53.991			2
121	58.945	30.530		0.455		8
122	11.078*		67.038			6
123	52.057	26.963		0.382		8
124	11.659*		70.554			2

\* Total flexural uplift load, W

0.061 x 2 x 8 Z-Purlin						
Test No.	Buckling Load, K	Elastic Stress		k <sub>af</sub>		Failure Mode
		Axial, ksi	Flexural, ksi			
129	7.434	9.169		0.345		1
130	1.108*		26.612			3
131	6.942	8.562		0.321		1
132	1.112*		26.692			3
133	7.434	9.169		0.285		1
134	1.340*		32.174			3
135	7.186	8.863		0.274		1
136	1.346*		32.306			3
137	7.434	9.169		0.337		1
138	1.134*		27.222			3
139	6.942	8.563		0.314		1
140	1.138*		27.313			3
141	7.434	9.169		0.277		1
142	1.378*		33.094			3
143	7.186	8.863		0.267		1
144	1.385*		33.244			3

\* Total flexural uplift load, W



0.120 x 2 x 8 Z-Purlin						
Test No.	Buckling Load, K	Elastic Stress		$k_{af}$		Failure Mode
		Axial, ksi	Flexural, ksi			
145	20.928	13.324		0.497		2
146	2.122*		26.825			2
147	18.775	11.954		0.450		2
148	2.102*		26.570			2
149	28.855	18.371		0.426		8
150	3.412*		43.121			3
151	28.193	17.949		0.417		8
152	3.407*		43.056			3
153	24.314	15.479		0.546		3
154	2.241*		28.327			3
155	21.199	13.497		0.477		2
156	2.240*		28.313			3
157	30.993	19.732		0.428		8
158	3.648*		46.108			3
159	30.898	19.671		0.427		8
160	3.643*		46.041			3

\* Total flexural uplift load, W

<b>0.061 x 3.5 x 8 Z-Purlin</b>						
Test No.	Buckling Load, K	Elastic Stress		$k_{af}$		Failure Mode
		Axial, ksi	Flexural, ksi			
161	8.661	8.715		0.305		1
162	1.647*		28.559			6
163	7.720	7.768		0.248		1
164	1.806*		31.315			1
165	8.662	8.716		0.300		1
166	1.676*		29.064			6
167	8.025	8.075		0.244		1
168	1.906*		33.051			1
169	8.661	8.715		0.318		1
170	1.582*		27.431			6
171	7.737	7.786		0.243		1
172	1.845*		31.996			1
173	8.662	8.716		0.313		1
174	1.607*		27.867			6
175	8.032	8.083		0.241		1
176	1.936*		33.573			6

\* Total flexural uplift load, W

<b>0.120 x 3.5 x 8 Z-Purlin</b>						
Test No.	Buckling Load, K	Elastic Stress		$k_{af}$		Failure Mode
		Axial, ksi	Flexural, ksi			
177	25.528	13.222		0.399		2
178	3.653*		33.157			2
179	23.114	11.972		0.368		2
180	3.580*		32.500			2
181	31.575	16.354		0.287		2
182	6.273*		56.941			3
183	30.563	15.830		0.278		2
184	6.279*		56.998			3
185	32.288	16.723		0.448		2
186	4.111*		37.311			2
187	27.787	14.392		0.396		2
188	3.999*		36.302			2
189	39.974	20.704		0.343		2
190	6.652*		60.380			3
191	38.348	19.862		0.329		2
192	6.660*		60.450			3

\* Total flexural uplift load, W

0.061 x 2 x 12 Z-Purlin						
Test No.	Buckling Load, K	Elastic Stress		$k_{af}$		Failure Mode
		Axial, ksi	Flexural, ksi			
193	4.330	4.105		0.191		1
194	2.384*		21.467			1
195	3.523	3.340		0.249		1
196	1.490*		13.419			1
197	4.328	4.103		0.234		1
198	1.300*		17.555			2
199	3.831	3.632		0.222		1
200	1.213*		16.380			1
201	4.330	4.106		0.201		1
202	2.271*		20.447			1
203	3.626	3.438		0.251		1
204	1.521*		13.693			1
205	4.328	4.103		0.193		1
206	1.577*		21.295			1
207	4.001	3.793		0.216		1
208	1.299*		17.546			1
209	4.330	4.105		0.187		1
210	2.436*		21.927			1
211	3.550	3.366		0.246		1
212	1.518*		13.668			1
213	4.328	4.103		0.226		1
214	1.346*		18.179			2
215	3.836	3.636		0.221		1
216	1.219*		16.461			1
217	4.331	4.106		0.196		1
218	2.321*		20.894			1
219	3.646	3.457		0.248		1
220	1.547*		13.925			1
221	4.328	4.103		0.191		1
222	1.589*		21.457			1
223	4.002	3.794		0.215		1
224	1.305*		17.625			1

\* Total flexural uplift load, W

0.120 x 2 x 12 Z-Purlin						
Test No.	Buckling Load, K	Elastic Stress		k <sub>af</sub>		Failure Mode
		Axial, ksi	Flexural, ksi			
225	19.692	9.602		0.411		2
226	4.964*		23.343			2
227	19.400	9.460		0.408		2
228	4.926*		23.166			2
229	17.045	8.312		0.478		2
230	2.463*		17.375			2
231	16.890	8.236		0.476		2
232	2.455*		17.316			2
233	25.481	12.425		0.386		2
234	6.845*		32.188			2
235	24.473	11.934		0.367		8
236	6.911*		32.498			2
237	26.887	13.111		0.465		7
238	3.999*		28.211			3
239	26.586	12.964		0.457		7
240	4.020*		28.357			3
241	25.048	12.215		0.467		2
242	5.560*		26.146			2
243	24.183	11.793		0.456		7
244	5.498*		25.854			2
245	19.241	9.382		0.506		2
246	2.631*		18.557			2
247	19.171	9.348		0.505		2
248	2.622*		18.498			2
249	29.020	14.151		0.385		8
250	7.820*		36.772			2
251	26.208	12.780		0.344		8
252	7.910*		37.199			2
253	28.661	13.976		0.472		7
254	4.194*		29.583			3
255	28.002	13.655		0.459		7
256	4.219*		29.761			3

\* Total flexural uplift load, W

0.061 x 3.5 x 12 Z-Purlin						
Test No.	Buckling Load, K	Elastic Stress		k <sub>af</sub>		Failure Mode
		Axial, ksi	Flexural, ksi			
257	4.912	3.968		0.213		1
258	2.746*		18.645			1
259	4.161	3.361		0.280		1
260	1.771*		12.020			1
261	4.912	3.968		0.201		1
262	1.942*		19.773			1
263	4.248	3.432		0.243		1
264	1.386*		14.110			1
265	4.913	3.969		0.234		1
266	2.499*		16.962			1
267	4.197	3.391		0.290		1
268	1.721*		11.681			1
269	4.912	3.969		0.211		1
270	1.848*		18.815			1
271	4.363	3.525		0.247		1
272	1.401*		14.262			1
273	4.913	3.969		0.200		1
274	2.930*		19.893			1
275	4.181	3.378		0.268		1
276	1.855*		12.596			1
277	4.911	3.968		0.195		1
278	1.997*		20.334			1
279	4.269	3.449		0.239		1
280	1.419*		14.453			1
281	4.914	3.970		0.215		1
282	2.721*		18.471			1
283	4.212	3.402		0.278		1
284	1.804*		12.247			1
285	4.912	3.968		0.205		1
286	1.901*		19.355			1
287	4.377	3.536		0.242		1
288	1.433*		14.590			1

\* Total flexural uplift load, W

0.120 x 3.5 x 12 Z-Purlin						
Test No.	Buckling Load, K	Elastic Stress		k <sub>af</sub>		Failure Mode
		Axial, ksi	Flexural, ksi			
289	36.534	15.155		0.345		1
290	12.442*		43.931			2
291	30.781	12.768		0.292		1
292	12.374*		43.692			2
293	29.128	12.083		0.439		2
294	5.195*		27.515			2
295	28.086	11.651		0.428		2
296	5.141*		27.230			2
297	36.549	15.161		0.310		1
298	13.841*		48.868			2
299	31.856	13.214		0.269		1
300	13.928*		49.176			2
301	36.554	15.163		0.375		1
302	7.638*		40.452			2
303	34.017	14.111		0.348		1
304	7.664*		40.592			2
305	36.534	15.155		0.296		1
306	14.479*		51.121			6
307	30.652	12.715		0.249		1
308	14.460*		51.054			2
309	36.535	15.155		0.489		1
310	5.853*		30.996			2
311	31.753	13.172		0.432		1
312	5.763*		30.522			2
313	36.548	15.161		0.276		1
314	15.548*		54.896			6
315	31.722	13.159		0.246		1
316	15.175*		53.580			1
317	36.552	15.162		0.327		1
318	8.752*		46.351			2
319	34.071	14.133		0.304		1
320	8.787*		46.537			2

\* Total flexural uplift load, W

0.082 x 2 x 8 Z-Purlin						
Test No.	Buckling Load, K	Elastic Stress		$k_{af}$		Failure Mode
		Axial, ksi	Flexural, ksi			
321	15.899	14.667		0.461		2
322	2.640*		31.827			2
323	14.741	13.598		0.433		2
324	2.603*		31.386			2
325	15.533	14.330		0.531		3
326	1.492*		26.978			3
327	13.986	12.903		0.478		2
328	1.493*		26.995			3
329	17.893	16.506		0.366		1
330	3.738*		45.068			2
331	16.217	14.960		0.330		1
332	3.759*		45.315			2
333	17.887	16.501		0.441		1
334	2.067*		37.379			3
335	17.492	16.137		0.431		1
336	2.069*		37.407			3
337	17.891	16.504		0.471		1
338	2.910*		35.078			2
339	15.012	13.849		0.402		1
340	2.856*		34.435			2
341	16.811	15.509		0.558		3
342	1.537*		27.796			3
343	15.085	13.916		0.500		2
344	1.538*		27.815			3
345	17.892	16.506		0.329		1
346	4.164*		50.200			2
347	16.257	14.997		0.297		1
348	4.192*		50.532			2
349	17.888	16.501		0.423		1
350	2.159*		39.036			3
351	17.500	16.144		0.413		1
352	2.161*		39.076			3

\* Total flexural uplift load, W



0.105 x 2 x 8 Z-Purlin						
Test No.	Buckling Load, K	Elastic Stress		$k_{af}$		Failure Mode
		Axial, ksi	Flexural, ksi			
353	18.751	13.590		0.434		2
354	3.282*		31.327			2
355	17.712	12.837		0.417		2
356	3.223*		30.757			2
357	19.139	13.871		0.513		2
358	1.890*		27.052			3
359	17.040	12.350		0.458		2
360	1.884*		26.978			2
361	26.186	18.978		0.385		8
362	5.161*		49.257			2
363	24.476	17.739		0.359		8
364	5.170*		49.345			2
365	25.738	18.653		0.451		8
366	2.892*		41.404			3
367	24.952	18.083		0.437		8
368	2.889*		41.366			3
369	23.932	17.344		0.492		2
370	3.691*		35.233			2
371	22.162	16.062		0.468		2
372	3.599*		34.348			2
373	21.333	15.461		0.551		3
374	1.961*		28.069			3
375	18.894	13.693		0.488		2
376	1.960*		28.062			3
377	36.979	26.800		0.480		7
378	5.850*		55.834			3
379	33.609	24.358		0.434		7
380	5.881*		56.130			2
381	27.310	19.793		0.451		2
382	3.066*		43.899			3
383	26.947	19.529		0.445		8
384	3.064*		43.863			3

\* Total flexural uplift load, W

0.082 x 3.5 x 8 Z-Purlin						
Test No.	Buckling Load, K	Elastic Stress		k <sub>af</sub>		Failure Mode
		Axial, ksi	Flexural, ksi			
385	21.008	15.795		0.340		1
386	5.352*		46.510			6
387	17.533	13.183		0.276		1
388	5.505*		47.832			8
389	19.651	14.775		0.432		2
390	2.627*		34.240			2
391	17.378	13.066		0.387		2
392	2.589*		33.751			2
393	21.012	15.798		0.314		1
394	5.788*		50.292			6
395	18.329	13.781		0.281		1
396	5.650*		49.094			1
397	21.011	15.798		0.387		1
398	3.128*		40.770			6
399	19.924	14.981		0.322		1
400	3.574*		46.589			6
401	21.007	15.795		0.392		1
402	4.641*		40.328			6
403	17.565	13.207		0.260		1
404	5.847*		50.809			1
405	21.007	15.795		0.423		1
406	2.866*		37.353			2
407	18.821	14.151		0.386		1
408	2.815*		36.689			2
409	21.011	15.798		0.370		1
410	4.919*		42.748			6
411	18.337	13.787		0.263		1
412	6.029*		52.393			1
413	21.011	15.798		0.410		1
414	2.956*		38.524			6
415	19.942	14.994		0.341		1
416	3.371*		43.935			6

\* Total flexural uplift load, W

<b>0.105 x 3.5 x 8 Z-Purlin</b>						
Test No.	Buckling Load, K	Elastic Stress		$k_{af}$		Failure Mode
		Axial, ksi	Flexural, ksi			
417	28.627	16.891		0.355		2
418	6.939*		47.633			2
419	27.095	15.987		0.339		2
420	6.874*		47.187			2
421	23.408	13.812		0.410		2
422	3.269*		33.660			2
423	21.023	12.404		0.375		2
424	3.209*		33.044			2
425	31.280	18.457		0.315		2
426	8.529*		58.548			2
427	29.927	17.658		0.300		2
428	8.572*		58.843			2
429	28.704	16.936		0.308		2
430	5.347*		55.055			2
431	27.503	16.228		0.295		2
432	5.343*		55.012			2
433	42.957	25.346		0.471		2
434	7.839*		53.809			6
435	36.727	21.671		0.401		1
436	7.874*		54.052			2
437	28.809	16.998		0.454		2
438	3.638*		37.456			2
439	24.708	14.578		0.399		2
440	3.550*		36.554			2
441	43.983	25.952		0.456		1
442	8.291*		56.911			6
443	38.996	23.009		0.336		1
444	9.968*		68.423			2
445	35.122	20.723		0.402		2
446	5.007*		51.553			6
447	33.311	19.655		0.345		2
448	5.541*		57.047			6

\* Total flexural uplift load, W

0.082 x 2 x 12 Z-Purlin						
Test No.	Buckling Load, K	Elastic Stress		$k_{af}$		Failure Mode
		Axial, ksi	Flexural, ksi			
449	10.217	7.236		0.305		1
450	3.507*		23.717			2
451	8.304	5.881		0.249		1
452	3.496*		23.641			2
453	10.214	7.234		0.404		1
454	1.765*		17.903			2
455	9.092	6.439		0.359		1
456	1.767*		17.927			2
457	10.221	7.239		0.250		1
458	4.289*		29.004			2
459	8.778	6.217		0.235		1
460	3.913*		26.461			1
461	10.218	7.237		0.285		1
462	2.503*		25.390			3
463	9.698	6.868		0.268		1
464	2.529*		25.648			3
465	10.217	7.236		0.280		1
466	3.817*		25.813			2
467	8.370	5.928		0.233		1
468	3.766*		25.470			1
469	10.214	7.234		0.386		1
470	1.850*		18.761			2
471	9.102	6.446		0.343		1
472	1.853*		18.796			2
473	10.221	7.239		0.227		1
474	4.713*		31.871			2
475	8.817	6.245		0.231		1
476	3.992*		26.992			1
477	10.218	7.237		0.276		1
478	2.581*		26.179			3
479	9.699	6.869		0.260		1
480	2.610*		26.470			3

\* Total flexural uplift load, W

0.105 x 2 x 12 Z-Purlin						
Test No.	Buckling Load, K	Elastic Stress		$k_{af}$		Failure Mode
		Axial, ksi	Flexural, ksi			
481	17.974	9.987		0.424		2
482	4.408*		23.528			2
483	16.702	9.280		0.397		8
484	4.380*		23.378			2
485	15.464	8.592		0.488		2
486	2.200*		17.609			2
487	15.256	8.477		0.482		2
488	2.195*		17.576			2
489	20.168	11.206		0.358		8
490	5.860*		31.275			2
491	17.946	9.971		0.315		8
492	5.932*		31.659			2
493	20.214	11.231		0.411		8
494	3.412*		27.313			3
495	19.454	10.809		0.393		8
496	3.435*		27.496			3
497	20.332	11.297		0.433		8
498	4.887*		26.081			2
499	16.867	9.372		0.363		8
500	4.841*		25.838			2
501	17.157	9.533		0.511		2
502	2.332*		18.671			2
503	16.915	9.398		0.504		2
504	2.329*		18.642			2
505	20.353	11.309		0.321		8
506	6.603*		35.239			2
507	18.057	10.033		0.281		8
508	6.696*		35.738			2
509	20.277	11.266		0.396		8
510	3.554*		28.456			3
511	19.521	10.846		0.378		8
512	3.581*		28.672			3

\* Total flexural uplift load, W

0.082 x 3.5 x 12 Z-Purlin						
Test No.	Buckling Load, K	Elastic Stress		$k_{af}$		Failure Mode
		Axial, ksi	Flexural, ksi			
513	11.864	7.156		0.208		1
514	6.745*		34.342			1
515	9.987	6.023		0.265		1
516	4.461*		22.712			1
517	11.861	7.154		0.254		1
518	3.694*		28.210			2
519	10.266	6.192		0.235		1
520	3.447*		26.325			1
521	11.866	7.157		0.228		1
522	6.165*		31.386			1
523	10.189	6.145		0.278		1
524	4.336*		22.074			1
525	11.864	7.156		0.215		1
526	4.353*		33.242			6
527	10.781	6.502		0.236		1
528	3.604*		27.520			1
529	11.864	7.155		0.222		1
530	6.335*		32.254			6
531	10.004	6.034		0.251		1
532	4.722*		24.041			1
533	11.861	7.154		0.236		1
534	3.974*		30.348			6
535	10.317	6.223		0.229		1
536	3.552*		27.126			1
537	11.866	7.157		0.210		1
538	6.686*		34.043			1
539	10.189	6.146		0.263		1
540	4.593*		23.384			1
541	11.864	7.155		0.225		1
542	4.160*		31.773			6
543	10.804	6.516		0.230		1
544	3.711*		28.340			1

\* Total flexural uplift load, W

0.105 x 3.5 x 12 Z-Purlin						
Test No.	Buckling Load, K	Elastic Stress		k <sub>af</sub>		Failure Mode
		Axial, ksi	Flexural, ksi			
545	24.676	11.668		0.263		1
546	11.043*		44.302			2
547	20.753	9.813		0.258		1
548	9.478*		38.024			1
549	24.673	11.667		0.419		1
550	4.629*		27.855			2
551	21.416	10.127		0.365		1
552	4.610*		27.743			2
553	24.683	11.672		0.241		1
554	12.072*		48.429			2
555	21.389	10.114		0.270		1
556	9.342*		37.479			1
557	24.683	11.671		0.299		1
558	6.490*		39.057			2
559	22.914	10.835		0.275		1
560	6.544*		39.378			2
561	24.676	11.668		0.270		1
562	10.761*		43.170			6
563	20.713	9.794		0.241		1
564	10.117*		40.586			1
565	24.672	11.666		0.376		1
566	5.161*		31.054			2
567	21.537	10.184		0.330		1
568	5.123*		30.829			2
569	24.680	11.670		0.251		1
570	11.588*		46.488			6
571	21.328	10.085		0.251		1
572	10.003*		40.128			1
573	24.681	11.671		0.273		1
574	7.104*		42.748			6
575	22.968	10.861		0.243		1
576	7.414*		44.615			2

\* Total flexural uplift load, W

Failure Mode Key:

1. Local Buckling
2. One, half sine wave lateral buckle of bottom flange
3. Two, half sine wave lateral buckles of bottom flange
4. Three, half sine wave lateral buckles of bottom flange
5. Torsional buckling
6. Distortional buckling of bottom flange
7. Combined local buckle with two, half sine wave lateral buckles of bottom flange
8. Combined local buckle with one, half sine wave lateral buckle of bottom flange



**APPENDIX 3: CORRECTED FINITE ELEMENT MODEL TEST RESULTS**

0.061 x 2 x 8 Z-Purlin						
Test No.	Buckling Load, K	Corrected Stress		k <sub>af</sub>		Failure Mode
		Axial, ksi	Flexural, ksi			
1	7.436	8.043		0.255		1
2	1.973*		31.550			2
3	6.192	6.698		0.214		1
4	1.952*		31.232			1
9	7.436	8.043		0.230		1
10	2.432*		35.000			2
11	6.528	7.062		0.210		1
12	2.119*		33.578			1
17	7.436	8.043		0.239		1
18	2.127*		33.681			2
19	6.221	6.729		0.212		1
20	1.988*		31.771			1
25	7.436	8.043		0.230		1
26	2.639*		35.000			2
27	6.545	7.079		0.208		1
28	2.156*		34.056			1

\* Total flexural uplift load, W

0.120 x 2 x 8 Z-Purlin						
Test No.	Buckling Load, K	Corrected Stress		$k_{af}$		Failure Mode
		Axial, ksi	Flexural, ksi			
33	20.378	11.378		0.367		2
34	3.679*		30.990			2
35	19.388	10.825		0.356		2
36	3.607*		30.390			2
41	28.335	15.821		0.452		2
42	6.029*		35.000			2
43	26.852	14.993		0.428		2
44	6.030*		35.000			2
49	26.868	15.002		0.433		2
50	4.186*		34.640			2
51	25.090	14.009		0.413		2
52	4.070*		33.887			2
57	46.304	18.000		0.514		7
58	6.798*		35.000			3
59	40.830	18.000		0.514		8
60	6.832*		35.000			3

\* Total flexural uplift load, W

<b>0.061 x 3.5 x 8 Z-Purlin</b>						
Test No.	Buckling Load, K	Corrected Stress		$k_{af}$		Failure Mode
		Axial, ksi	Flexural, ksi			
65	8.662	7.644		0.233		1
66	2.857*		32.841			6
67	7.217	6.369		0.247		1
68	2.231*		25.787			1
73	8.663	7.645		0.222		1
74	3.034*		34.494			1
75	7.393	6.525		0.253		1
76	2.230*		25.778			1
81	8.662	7.644		0.259		1
82	2.549*		29.468			6
83	7.249	6.397		0.236		1
84	2.347*		27.129			1
89	8.662	7.644		0.246		1
90	2.684*		31.024			6
91	7.415	6.543		0.241		1
92	2.348*		27.141			1

\* Total flexural uplift load, W

<b>0.120 x 3.5 x 8 Z-Purlin</b>						
Test No.	Buckling Load, K	Corrected Stress		$k_{af}$		Failure Mode
		Axial, ksi	Flexural, ksi			
97	30.821	14.000		0.400		2
98	7.809*		35.000			2
99	29.394	13.352		0.381		2
100	7.725*		35.000			2
105	33.607	15.266		0.436		2
106	9.889*		35.000			2
107	32.446	14.738		0.421		2
108	9.914*		35.000			2
113	47.781	18.000		0.514		2
114	9.139*		35.000			2
115	42.595	18.000		0.514		2
116	8.922*		35.000			2
121	58.945	18.000		0.514		8
122	11.078*		35.000			6
123	52.057	18.000		0.514		8
124	11.659*		35.000			2

\* Total flexural uplift load, W

0.061 x 2 x 8 Z-Purlin						
Test No.	Buckling Load, K	Corrected Stress		$k_{af}$		Failure Mode
		Axial, ksi	Flexural, ksi			
129	7.434	8.041		0.302		1
130	1.108*		26.612			3
131	6.942	7.509		0.281		1
132	1.112*		26.692			3
133	7.434	8.041		0.251		1
134	1.340*		32.093			3
135	7.186	7.773		0.241		1
136	1.346*		32.212			3
137	7.434	8.041		0.295		1
138	1.134*		27.222			3
139	6.942	7.509		0.275		1
140	1.138*		27.313			3
141	7.434	8.041		0.244		1
142	1.378*		32.899			3
143	7.186	7.773		0.235		1
144	1.385*		33.026			3

\* Total flexural uplift load, W

0.120 x 2 x 8 Z-Purlin						
Test No.	Buckling Load, K	Corrected Stress		k <sub>af</sub>		Failure Mode
		Axial, ksi	Flexural, ksi			
145	20.928	11.685		0.436		2
146	2.122*		26.825			2
147	18.775	10.483		0.395		2
148	2.102*		26.570			2
149	28.855	16.111		0.460		8
150	3.412*		35.000			3
151	28.193	15.741		0.450		8
152	3.407*		35.000			3
153	24.314	13.575		0.479		3
154	2.241*		28.327			3
155	21.199	11.836		0.418		2
156	2.240*		28.313			3
157	30.993	17.305		0.494		8
158	3.648*		35.000			3
159	30.898	17.252		0.493		8
160	3.643*		35.000			3

\* Total flexural uplift load, W

<b>0.061 x 3.5 x 8 Z-Purlin</b>						
Test No.	Buckling Load, K	Corrected Stress		$k_{af}$		Failure Mode
		Axial, ksi	Flexural, ksi			
161	8.661	7.643		0.268		1
162	1.647*		28.559			6
163	7.720	6.813		0.218		1
164	1.806*		31.297			1
165	8.662	7.644		0.263		1
166	1.676*		29.064			6
167	8.025	7.082		0.215		1
168	1.906*		32.863			1
169	8.661	7.643		0.279		1
170	1.582*		27.431			6
171	7.737	6.828		0.214		1
172	1.845*		31.931			1
173	8.662	7.644		0.274		1
174	1.607*		27.867			6
175	8.032	7.088		0.213		1
176	1.936*		33.302			6

\* Total flexural uplift load, W



<b>0.120 x 3.5 x 8 Z-Purlin</b>						
Test No.	Buckling Load, K	Corrected Stress		$k_{af}$		Failure Mode
		Axial, ksi	Flexural, ksi			
177	25.528	11.596		0.352		2
178	3.653*		32.953			2
179	23.114	10.499		0.324		2
180	3.580*		32.384			2
181	31.575	14.343		0.410		2
182	6.273*		35.000			3
183	30.563	13.883		0.397		2
184	6.279*		35.000			3
185	32.288	14.666		0.419		2
186	4.111*		35.000			2
187	27.787	12.622		0.361		2
188	3.999*		35.000			2
189	39.974	18.000		0.514		2
190	6.652*		35.000			3
191	38.348	17.419		0.498		2
192	6.660*		35.000			3

\* Total flexural uplift load, W

0.061 x 2 x 12 Z-Purlin						
Test No.	Buckling Load, K	Corrected Stress		k <sub>af</sub>		Failure Mode
		Axial, ksi	Flexural, ksi			
193	4.330	3.600		0.168		1
194	2.384*		21.467			
195	3.523	2.929		0.218		1
196	1.490*		13.419			
197	4.328	3.598		0.205		1
198	1.300*		17.555			
199	3.831	3.186		0.194		1
200	1.213*		16.380			
201	4.330	3.601		0.176		1
202	2.271*		20.447			
203	3.626	3.015		0.220		1
204	1.521*		13.693			
205	4.328	3.599		0.169		1
206	1.577*		21.295			
207	4.001	3.326		0.190		1
208	1.299*		17.546			
209	4.330	3.600		0.164		1
210	2.436*		21.927			
211	3.550	2.952		0.216		1
212	1.518*		13.668			
213	4.328	3.599		0.198		1
214	1.346*		18.179			
215	3.836	3.189		0.194		1
216	1.219*		16.461			
217	4.331	3.601		0.172		1
218	2.321*		20.894			
219	3.646	3.032		0.218		1
220	1.547*		13.925			
221	4.328	3.599		0.168		1
222	1.589*		21.457			
223	4.002	3.327		0.189		1
224	1.305*		17.625			

\* Total flexural uplift load, W

0.120 x 2 x 12 Z-Purlin						
Test No.	Buckling Load, K	Corrected Stress		$k_{af}$		Failure Mode
		Axial, ksi	Flexural, ksi			
225	19.692	8.421		0.361		2
226	4.964*		23.343			
227	19.400	8.296		0.358		2
228	4.926*		23.166			
229	17.045	7.290		0.420		2
230	2.463*		17.375			
231	16.890	7.223		0.417		2
232	2.455*		17.316			
233	25.481	10.897		0.339		2
234	6.845*		32.105			
235	24.473	10.466		0.323		8
236	6.911*		32.382			
237	26.887	11.498		0.408		7
238	3.999*		28.211			
239	26.586	11.370		0.401		7
240	4.020*		28.357			
241	25.048	10.712		0.410		2
242	5.560*		26.146			
243	24.183	10.342		0.400		7
244	5.498*		25.854			
245	19.241	8.228		0.443		2
246	2.631*		18.557			
247	19.171	8.198		0.443		2
248	2.622*		18.498			
249	29.020	12.411		0.355		8
250	7.820*		35.000			
251	26.208	11.208		0.320		8
252	7.910*		35.000			
253	28.661	12.257		0.414		7
254	4.194*		29.583			
255	28.002	11.975		0.402		7
256	4.219*		29.761			

\* Total flexural uplift load, W

0.061 x 3.5 x 12 Z-Purlin						
Test No.	Buckling Load, K	Corrected Stress		k <sub>af</sub>		Failure Mode
		Axial, ksi	Flexural, ksi			
257	4.912	3.480		0.187		1
258	2.746*		18.645			1
259	4.161	2.948		0.245		1
260	1.771*		12.020			1
261	4.912	3.480		0.176		1
262	1.942*		19.773			1
263	4.248	3.010		0.213		1
264	1.386*		14.110			1
265	4.913	3.481		0.205		1
266	2.499*		16.692			1
267	4.197	2.974		0.255		1
268	1.721*		11.681			1
269	4.912	3.480		0.185		1
270	1.848*		18.815			1
271	4.363	3.091		0.217		1
272	1.401*		14.262			1
273	4.913	3.481		0.175		1
274	2.930*		19.893			1
275	4.181	2.962		0.235		1
276	1.855*		12.596			1
277	4.911	3.480		0.171		1
278	1.997*		20.334			1
279	4.269	3.024		0.209		1
280	1.419*		14.453			1
281	4.914	3.482		0.188		1
282	2.721*		18.471			1
283	4.212	2.984		0.244		1
284	1.804*		12.247			1
285	4.912	3.480		0.180		1
286	1.901*		19.355			1
287	4.377	3.101		0.213		1
288	1.433*		14.590			1

\* Total flexural uplift load, W

0.120 x 3.5 x 12 Z-Purlin						
Test No.	Buckling Load, K	Corrected Stress		$k_{af}$		Failure Mode
		Axial, ksi	Flexural, ksi			
289	36.534	13.291		0.380		1
290	12.442*		35.000			2
291	30.781	11.198		0.320		1
292	12.374*		35.000			2
293	29.128	10.597		0.385		2
294	5.195*		27.515			2
295	28.086	10.218		0.375		2
296	5.141*		27.230			2
297	36.549	13.296		0.380		1
298	13.841*		35.000			2
299	31.856	11.589		0.331		1
300	13.928*		35.000			2
301	36.554	13.298		0.380		1
302	7.638*		35.000			2
303	34.017	12.375		0.354		1
304	7.664*		35.000			2
305	36.534	13.291		0.380		1
306	14.479*		35.000			6
307	30.652	11.151		0.319		1
308	14.460*		35.000			2
309	36.535	13.291		0.429		1
310	5.853*		30.990			2
311	31.753	11.552		0.378		1
312	5.763*		30.522			2
313	36.548	13.296		0.380		1
314	15.548*		35.000			6
315	31.722	11.540		0.330		1
316	15.175*		35.000			1
317	36.552	13.297		0.380		1
318	8.752*		35.000			2
319	34.071	12.395		0.354		1
320	8.787*		35.000			2

\* Total flexural uplift load, W

0.082 x 2 x 8 Z-Purlin						
Test No.	Buckling Load, K	Corrected Stress		$k_{af}$		Failure Mode
		Axial, ksi	Flexural, ksi			
321	15.899	12.863		0.405		2
322	2.640*		31.776			2
323	14.741	11.926		0.380		2
324	2.603*		31.364			2
325	15.533	12.567		0.466		3
326	1.492*		26.978			3
327	13.986	11.316		0.419		2
328	1.493*		26.995			3
329	17.893	14.476		0.414		1
330	3.738*		35.000			2
331	16.217	13.120		0.375		1
332	3.759*		35.000			2
333	17.887	14.472		0.413		1
334	2.067*		35.000			3
335	17.492	14.152		0.404		1
336	2.069*		35.000			3
337	17.891	14.474		0.420		1
338	2.910*		34.495			2
339	15.012	12.146		0.357		1
340	2.856*		33.998			2
341	16.811	13.601		0.489		3
342	1.537*		27.796			3
343	15.085	12.204		0.439		2
344	1.538*		27.815			3
345	17.892	14.476		0.414		1
346	4.164*		35.000			2
347	16.257	13.152		0.376		1
348	4.192*		35.000			2
349	17.888	14.472		0.413		1
350	2.159*		35.000			3
351	17.500	14.158		0.405		1
352	2.161*		35.000			3

\* Total flexural uplift load, W

0.105 x 2 x 8 Z-Purlin						
Test No.	Buckling Load, K	Corrected Stress		$k_{af}$		Failure Mode
		Axial, ksi	Flexural, ksi			
353	18.751	11.918		0.381		2
354	3.282*		31.308			2
355	17.712	11.258		0.366		2
356	3.223*		30.757			2
357	19.139	12.165		0.450		2
358	1.890*		27.052			3
359	17.040	10.831		0.401		2
360	1.884*		26.978			2
361	26.186	16.644		0.476		8
362	5.161*		35.000			2
363	24.476	15.557		0.444		8
364	5.170*		35.000			2
365	25.738	16.359		0.467		8
366	2.892*		35.000			3
367	24.952	15.859		0.453		8
368	2.889*		35.000			3
369	23.932	15.211		0.439		2
370	3.691*		34.612			2
371	22.162	14.086		0.415		2
372	3.599*		33.929			2
373	21.333	13.559		0.483		3
374	1.961*		28.069			3
375	18.894	12.009		0.428		2
376	1.960*		28.062			3
377	36.979	18.000		0.514		7
378	5.850*		35.000			3
379	33.609	18.000		0.514		7
380	5.881*		35.000			2
381	27.310	17.358		0.496		2
382	3.066*		35.000			3
383	26.947	17.127		0.489		8
384	3.064*		35.000			3

\* Total flexural uplift load, W

0.082 x 3.5 x 8 Z-Purlin						
Test No.	Buckling Load, K	Corrected Stress		k <sub>af</sub>		Failure Mode
		Axial, ksi	Flexural, ksi			
385	21.008	13.852		0.396		1
386	5.352*		35.000			
387	17.533	11.561		0.330		1
388	5.505*		35.000			
389	19.651	12.958		0.383		2
390	2.627*		33.844			
391	17.378	11.459		0.343		2
392	2.589*		33.449			
393	21.012	13.855		0.396		1
394	5.788*		35.000			
395	18.329	12.086		0.345		1
396	5.650*		35.000			
397	21.011	13.855		0.396		1
398	3.128*		35.000			
399	19.924	13.138		0.375		1
400	3.574*		35.000			
401	21.007	13.852		0.396		1
402	4.641*		35.000			
403	17.565	11.582		0.331		1
404	5.847*		35.000			
405	21.007	13.852		0.396		1
406	2.866*		35.000			
407	18.821	12.411		0.355		1
408	2.815*		35.000			
409	21.011	13.855		0.396		1
410	4.919*		35.000			
411	18.337	12.091		0.345		1
412	6.029*		35.000			
413	21.011	13.855		0.396		1
414	2.956*		35.000			
415	19.942	13.150		0.376		1
416	3.371*		35.000			

\* Total flexural uplift load, W



<b>0.105 x 3.5 x 8 Z-Purlin</b>						
Test No.	Buckling Load, K	Corrected Stress		$k_{af}$		Failure Mode
		Axial, ksi	Flexural, ksi			
417	28.627	14.813		0.423		2
418	6.939*		35.000			2
419	27.095	14.021		0.401		2
420	6.874*		35.000			2
421	23.408	12.113		0.363		2
422	3.269*		33.373			2
423	21.023	10.879		0.331		2
424	3.209*		32.856			2
425	31.280	16.186		0.462		2
426	8.529*		35.000			2
427	29.927	15.486		0.442		2
428	8.572*		35.000			2
429	28.704	14.853		0.424		2
430	5.347*		35.000			2
431	27.503	14.232		0.407		2
432	5.343*		35.000			2
433	42.957	18.000		0.514		2
434	7.839*		35.000			6
435	36.727	18.000		0.514		1
436	7.874*		35.000			2
437	28.809	14.907		0.426		2
438	3.638*		35.000			2
439	24.708	12.785		0.365		2
440	3.550*		35.000			2
441	43.983	18.000		0.514		1
442	8.291*		35.000			6
443	38.996	18.000		0.514		1
444	9.968*		35.000			2
445	35.122	18.000		0.514		2
446	5.007*		35.000			6
447	33.311	17.237		0.492		2
448	5.541*		35.000			6

\* Total flexural uplift load, W

0.082 x 2 x 12 Z-Purlin						
Test No.	Buckling Load, K	Corrected Stress		$k_{af}$		Failure Mode
		Axial, ksi	Flexural, ksi			
449	10.217	6.346		0.268		1
450	3.507*		23.717			2
451	8.304	5.157		0.218		1
452	3.496*		23.641			2
453	10.214	6.344		0.354		1
454	1.765*		17.903			2
455	9.092	5.647		0.315		1
456	1.767*		17.927			2
457	10.221	6.348		0.219		1
458	4.289*		29.004			2
459	8.778	5.452		0.206		1
460	3.913*		26.461			1
461	10.218	6.346		0.250		1
462	2.503*		25.390			3
463	9.698	6.023		0.235		1
464	2.529*		25.648			3
465	10.217	6.346		0.246		1
466	3.817*		25.813			2
467	8.370	5.199		0.204		1
468	3.766*		25.470			1
469	10.214	6.344		0.338		1
470	1.850*		18.761			2
471	9.102	5.654		0.301		1
472	1.853*		18.796			2
473	10.221	6.349		0.200		1
474	4.713*		31.817			2
475	8.817	5.476		0.203		1
476	3.992*		26.992			1
477	10.218	6.346		0.242		1
478	2.581*		26.179			3
479	9.699	6.024		0.228		1
480	2.610*		26.470			3

\* Total flexural uplift load, W

0.105 x 2 x 12 Z-Purlin						
Test No.	Buckling Load, K	Corrected Stress		$k_{af}$		Failure Mode
		Axial, ksi	Flexural, ksi			
481	17.974	8.758		0.372		2
482	4.408*		23.528			
483	16.702	8.138		0.348		8
484	4.380*		23.378			
485	15.464	7.535		0.428		2
486	2.200*		17.609			
487	15.256	7.434		0.423		2
488	2.195*		17.576			
489	20.168	9.827		0.314		8
490	5.860*		31.258			
491	17.946	8.745		0.277		8
492	5.932*		31.621			
493	20.214	9.850		0.361		8
494	3.412*		27.313			
495	19.454	9.480		0.345		8
496	3.435*		27.496			
497	20.332	9.907		0.380		8
498	4.887*		26.081			
499	16.867	8.219		0.318		8
500	4.841*		25.838			
501	17.157	8.360		0.448		2
502	2.332*		18.671			
503	16.915	8.242		0.442		2
504	2.329*		18.642			
505	20.353	9.918		0.287		8
506	6.603*		34.616			
507	18.057	8.799		0.251		8
508	6.696*		34.986			
509	20.277	9.881		0.347		8
510	3.554*		28.456			
511	19.521	9.512		0.332		8
512	3.581*		28.672			

\* Total flexural uplift load, W

0.082 x 3.5 x 12 Z-Purlin						
Test No.	Buckling Load, K	Corrected Stress		$k_{af}$		Failure Mode
		Axial, ksi	Flexural, ksi			
513	11.864	6.275		0.185		1
514	6.745*		33.924			1
515	9.987	5.283		0.233		1
516	4.461*		22.712			1
517	11.861	6.274		0.222		1
518	3.694*		28.210			2
519	10.266	5.430		0.206		1
520	3.447*		26.325			1
521	11.866	6.277		0.200		1
522	6.165*		31.364			1
523	10.189	5.390		0.244		1
524	4.336*		22.074			1
525	11.864	6.275		0.190		1
526	4.353*		33.025			6
527	10.781	5.703		0.207		1
528	3.604*		27.520			1
529	11.864	6.275		0.195		1
530	6.335*		32.165			6
531	10.004	5.291		0.220		1
532	4.722*		24.041			1
533	11.861	6.274		0.207		1
534	3.974*		30.348			6
535	10.317	5.457		0.201		1
536	3.552*		27.126			1
537	11.866	6.276		0.186		1
538	6.686*		33.686			1
539	10.189	5.390		0.230		1
540	4.593*		23.384			1
541	11.864	6.275		0.198		1
542	4.160*		31.726			6
543	10.804	5.715		0.202		1
544	3.711*		27.340			1

\* Total flexural uplift load, W

0.105 x 3.5 x 12 Z-Purlin						
Test No.	Buckling Load, K	Corrected Stress		$k_{af}$		Failure Mode
		Axial, ksi	Flexural, ksi			
545	24.676	10.233		0.292		1
546	11.043*		35.000			2
547	20.753	8.606		0.246		1
548	9.478*		35.000			1
549	24.673	10.232		0.367		1
550	4.629*		27.855			2
551	21.416	8.881		0.320		1
552	4.610*		27.743			2
553	24.683	10.236		0.292		1
554	12.072*		35.000			2
555	21.389	8.870		0.253		1
556	9.342*		35.000			1
557	24.683	10.236		0.292		1
558	6.490*		35.000			2
559	22.914	9.502		0.271		1
560	6.544*		35.000			2
561	24.676	10.233		0.292		1
562	10.761*		35.000			6
563	20.713	8.590		0.245		1
564	10.117*		35.000			1
565	24.672	10.231		0.330		1
566	5.161*		31.046			2
567	21.537	8.931		0.290		1
568	5.123*		30.826			2
569	24.680	10.235		0.292		1
570	11.588*		35.000			6
571	21.328	8.845		0.253		1
572	10.003*		35.000			1
573	24.681	10.235		0.292		1
574	7.104*		35.000			6
575	22.968	9.525		0.272		1
576	7.414*		35.000			2

\* Total flexural uplift load, W

Failure Mode Key:

1. Local Buckling
2. One, half sine wave lateral buckle of bottom flange
3. Two, half sine wave lateral buckles of bottom flange
4. Three, half sine wave lateral buckles of bottom flange
5. Torsional buckling
6. Distortional buckling of bottom flange
7. Combined local buckle with two, half sine wave lateral buckles of bottom flange
8. Combined local buckle with one, half sine wave lateral buckle of bottom flange

**APPENDIX 4: SAMPLE CALCULATIONS FOR FINITE ELEMENT MODEL  
RESULTS**

Description of purlin designation: i.e.: Z- 8 x 2 x 0.75 x 0.082 refers to a Z-purlin 8-inches in depth with 2-inch wide flanges, a stiffener lip dimension of 0.75 inches and a thickness of 0.082 inches.

Properties of Various Available Purlin Sections: Properties obtained from CFS<sup>8</sup> Version

3.04

Z-8 x 2 x 0.75 x 0.061

$$A_g = 0.81 \text{ in}^2$$

$$S_g = 1.87 \text{ in}^3$$

Z-8 x 3.5 x 0.75 x 0.061

$$A_g = 0.99 \text{ in}^2$$

$$S_g = 2.60 \text{ in}^3$$

Z-8 x 2 x 0.75 x 0.082

$$A_g = 1.08 \text{ in}^2$$

$$S_g = 2.49 \text{ in}^3$$

Z-8 x 3.5 x 0.75 x 0.082

$$A_g = 1.33 \text{ in}^2$$

$$S_g = 3.45 \text{ in}^3$$

Z-8 x 2 x 0.75 x 0.105

$$A_g = 1.38 \text{ in}^2$$

$$S_g = 3.14 \text{ in}^3$$

Z-8 x 3.5 x 0.75 x 0.105

$$A_g = 1.69 \text{ in}^2$$

$$S_g = 4.37 \text{ in}^3$$

Z-8 x 2 x 0.75 x 0.120

$$A_g = 1.57 \text{ in}^2$$

$$S_g = 3.56 \text{ in}^3$$

Z-8 x 3.5 x 0.75 x 0.120

$$A_g = 1.93 \text{ in}^2$$

$$S_g = 4.96 \text{ in}^3$$



Z-12 x 2 x 0.75 x 0.061

$$A_g = 1.05 \text{ in}^2$$

$$S_g = 3.33 \text{ in}^3$$

Z-12 x 3.5 x 0.75 x 0.061

$$A_g = 1.24 \text{ in}^2$$

$$S_g = 4.42 \text{ in}^3$$

Z-12 x 2 x 0.75 x 0.082

$$A_g = 1.41 \text{ in}^2$$

$$S_g = 4.44 \text{ in}^3$$

Z-12 x 3.5 x 0.75 x 0.082

$$A_g = 1.66 \text{ in}^2$$

$$S_g = 5.89 \text{ in}^3$$

Z-12 x 2 x 0.75 x 0.105

$$A_g = 1.80 \text{ in}^2$$

$$S_g = 5.62 \text{ in}^3$$

Z-12 x 3.5 x 0.75 x 0.105

$$A_g = 2.11 \text{ in}^2$$

$$S_g = 7.48 \text{ in}^3$$

Z-12 x 2 x 0.75 x 0.120

$$A_g = 2.05 \text{ in}^2$$

$$S_g = 6.38 \text{ in}^3$$

Z-12 x 3.5 x 0.75 x 0.120

$$A_g = 2.41 \text{ in}^2$$

$$S_g = 8.50 \text{ in}^3$$

Sample Calculation for Elastic  $k_{af}$ :

Test #1:

Z-8 x 2 x 0.75 x 0.061

$$A_g = 0.81 \text{ in}^2$$

$$S_g = 1.87 \text{ in}^3$$

Buckling Load,  $P_{cr} = 7.44$  kips

$$\text{Axial Stress} = (F_c)_{\text{axial}} = P_{cr}/A_g = 7.44/0.81 = 9.17 \text{ ksi}$$

Test #2:

Z-8 x 2 x 0.75 x 0.061

$$A_g = 0.81 \text{ in}^2$$

$$S_g = 1.87 \text{ in}^3$$

Purlin Span = 20 ft.

Total Uplift Buckling Load = 1.97 kips (load is in terms of length multiplied by unit load)

$$M = \frac{wl^2}{8} = \frac{1.97(20)}{8} = 4.93 \text{ ft.} - \text{kips}$$

$$f_{bx} = \frac{4.93(12)}{1.87} = 31.6 \text{ ksi}$$

$$k_{af} = \frac{9.17}{31.6} = 0.29$$

Sample Calculation for Corrected  $k_{af}$ :

Axial Correction per Section C4 of the AISI Specification<sup>3</sup>

Based on  $F_y = 55 \text{ ksi}$

$$\lambda_c = \sqrt{\frac{F_y}{F_e}} = \sqrt{\frac{55}{9.17}} = 2.45 > 1.5 \therefore \text{Use Eq. C4-3}$$

$$(f_a)_{\text{corrected}} = \left[ \frac{0.877}{\lambda_c^2} \right] F_y = \left[ \frac{0.877}{2.45^2} \right] 55 = 8.04 \text{ ksi}$$

An additional check that needs to be satisfied is that the corrected axial stress is less than that determined from the experimental tests. The maximum axial stress obtained in the experimental tests was 18 ksi. The corrected axial stress obtained from

the finite element model is less than 18 ksi therefore no additional corrections need to be made.

Flexural Correction per Section C3.1.2 of the AISI Specification<sup>3</sup>

Based on  $F_y = 55$  ksi

$2.78F_y > f_{bx} > 0.56F_y \therefore$  Use Eq. C3.1.2-3

$$(f_{bx})_{\text{corrected}} = \frac{10}{9} F_y \left( 1 - \frac{10F_y}{36f_{bx}} \right) = \frac{10}{9} (55) \left( 1 - \frac{10(55)}{36(31.6)} \right) = 31.57 \text{ ksi}$$

An additional check that needs to be satisfied is that the corrected bending stress is less than that determined from the experimental tests. The maximum bending stress obtained in the experimental tests was 35 ksi. The corrected bending stress obtained from the finite element model is less than 35 ksi therefore no additional corrections need to be made.

Therefore the corrected value of  $kaf = \frac{8.04}{31.57} = 0.26$

**APPENDIX 5: DATA SHEETS FOR EXPERIMENTAL TESTS**

Test No.	Axial Load Location W.R.T. Purlin Centroid (in.)			
	N.E.	N.W.	S.E.	S.W.
A1	+0.24	+0.33	+0.28	+0.09
A2	0.00	-0.06	-0.03	+0.03
A3	0.00	+0.06	+0.01	+0.03
A4	0.00	0.00	-0.03	0.00

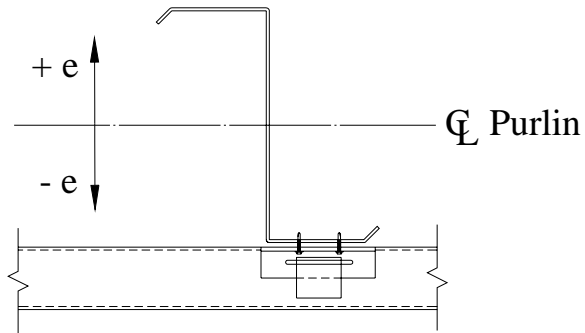

Test No.	Initial Lateral Sweep (in.)		Initial Vertical Camber (in.)	
	East Purlin	West Purlin	East Purlin	West Purlin
A1	0.00	0.31 East	0.13 Up	0.33 Up
A2	0.06 West	0.25 West	0.44 Up	0.63 Up
A3	0.25 West	0.00	0.25 Up	0.31 Up
A4	0.25 West	0.44 West	0.75 Up	0.25 Up

Test No.: A1Witness: JASTest Date: 12/13/00

Dial Gage Readings									
Load	$\Delta 1$	$\Delta 2$	$\Delta 3$	$\Delta 4$	$\Delta 5$	$\Delta 6$	$\Delta 7$	$\Delta 8$	Comments
(kips)	(in.)	(in.)	(in.)	(in.)	(in.)	(in.)	(in.)	(in.)	
0	0.496	0.495	0.704	0.801	0.500	0.500	0.402	-	
5	0.482	0.484	0.704	0.802	0.497	0.492	0.395	-	
10	0.479	0.496	0.704	0.802	0.497	0.493	0.380	-	
15	0.475	0.513	0.704	0.802	0.500	0.496	0.361	-	
20	0.473	0.533	0.701	0.800	0.502	0.499	0.338	-	
25	0.470	0.560	0.697	0.796	0.506	0.504	0.311	-	i
30	0.468	0.590	0.691	0.789	0.509	0.511	0.278	-	
35	0.468	0.629	0.688	0.783	0.512	0.520	0.238	-	
40	0.468	0.673	0.684	0.780	0.508	0.526	0.203	-	
45	0.469	0.722	0.684	0.776	0.504	0.535	0.172	-	
50	0.474	0.798	0.680	0.768	0.511	0.554	0.145	-	
55	0.477	0.900	0.673	0.760	0.524	0.580	0.120	-	
55	-	0.400	-	-	-	-	-	-	Rezero $\Delta 2$
60	0.486	0.533	0.669	0.751	0.545	0.612	0.093	-	

i – flange of east purlin deflecting laterally

## Failure Description:

- Failure load = 62.1 kips. Failure of West Purlin via lateral buckle of unsupported flange. Failure occurred 5.5 ft. from south end of purlin. Tabs on clips sheared at failure location.

Test No.: A1Witness: JASTest Date: 12/13/00

Strain Gage Readings					
Load (kips)	Gage 1 ( $\mu\epsilon$ )	Gage 2 ( $\mu\epsilon$ )	Gage 3 ( $\mu\epsilon$ )	Gage 4 ( $\mu\epsilon$ )	Comments
0	+2	-6	+4	0	-
5	-35	-58	-39	-66	-
10	-80	-107	-85	-116	-
15	-123	-159	-134	-161	-
20	-170	-207	-187	-201	-
25	-214	-257	-238	-247	-
30	-255	-309	-289	-288	-
35	-298	-358	-343	-330	-
40	-345	-421	-399	-377	-
45	-380	-477	-453	-417	-
50	-435	-529	-514	-450	-
55	-476	-591	-585	-494	-
60	-527	-654	-663	-533	-

Test No.: A2Witness: JASTest Date: 12/20/00

Dial Gage Readings									
Load	$\Delta 1$	$\Delta 2$	$\Delta 3$	$\Delta 4$	$\Delta 5$	$\Delta 6$	$\Delta 7$	$\Delta 8$	Comments
(kips)	(in.)	(in.)	(in.)	(in.)	(in.)	(in.)	(in.)	(in.)	
0	0.490	0.193	0.489	0.401	0.450	0.498	0.571	0.403	-
5	0.488	0.198	0.489	0.402	0.450	0.501	0.579	0.406	-
10	0.482	0.205	0.489	0.402	0.450	0.501	0.590	0.409	-
15	0.478	0.210	0.489	0.401	0.450	0.510	0.606	0.415	-
20	0.473	0.215	0.489	0.394	0.449	0.513	0.621	0.417	-
25	0.470	0.214	0.489	0.394	0.449	0.517	0.640	0.420	-
30	0.468	0.209	0.489	0.394	0.448	0.523	0.660	0.422	i
35	0.467	0.201	0.489	0.394	0.448	0.533	0.682	0.423	-
40	0.465	0.194	0.489	0.394	0.449	0.546	0.705	0.425	-
45	0.464	0.185	0.489	0.394	0.449	0.556	0.730	0.424	-
50	0.461	0.178	0.489	0.395	0.453	0.565	0.756	0.420	-
55	0.460	0.185	0.489	0.399	0.453	0.571	0.780	0.410	-
60	0.462	0.172	0.489	0.402	0.456	0.576	0.806	0.391	-
65	0.476	0.163	0.487	0.410	0.458	0.577	0.849	0.345	-

i – sweep noticed in unsupported flange of west purlin

#### Failure Description:

- Failure of West Purlin at 70 kips via lateral buckle of unsupported flange. Occurred 5.5 ft. from south end of purlin.



Test No.: A2Witness: JASTest Date: 12/20/00

Strain Gage Readings					
Load (kips)	Gage 1 ( $\mu\epsilon$ )	Gage 2 ( $\mu\epsilon$ )	Gage 3 ( $\mu\epsilon$ )	Gage 4 ( $\mu\epsilon$ )	Comments
0	0	-1	-1	-4	-
5	-50	-51	-55	-50	-
10	-99	-95	-108	-95	-
15	-148	-139	-158	-140	-
20	-194	-207	-181	-184	-
25	-245	-230	-259	-233	-
30	-294	-276	-306	-280	-
35	-346	-322	-356	-331	-
40	-397	-368	-409	-380	-
45	-452	-416	-459	-434	-
50	-509	-469	-510	-489	-
55	-567	-516	-571	-549	-
60	-628	-562	-619	-607	-
65	-698	-609	-678	-677	-

Test No.: A3Witness: JASTest Date: 12/27/00

Dial Gage Readings									
Load (kips)	$\Delta 1$ (in.)	$\Delta 2$ (in.)	$\Delta 3$ (in.)	$\Delta 4$ (in.)	$\Delta 5$ (in.)	$\Delta 6$ (in.)	$\Delta 7$ (in.)	$\Delta 8$ (in.)	Comments
0	0.512	0.502	0.502	0.596	0.357	0.500	0.500	0.502	-
2	0.512	0.503	0.501	0.596	0.355	0.499	0.504	0.505	-
4	0.512	0.503	0.501	0.596	0.348	0.499	0.511	0.509	-
6	0.512	0.506	0.501	0.595	0.343	0.498	0.521	0.516	-
8	0.513	0.507	0.497	0.595	0.343	0.498	0.529	0.523	-
10	0.515	0.510	0.496	0.595	0.343	0.498	0.539	0.529	-
15	0.521	0.519	0.489	0.593	0.343	0.498	0.564	0.544	-
20	0.527	0.526	0.481	0.589	0.341	0.498	0.598	0.558	-
25	0.538	0.535	0.476	0.585	0.340	0.498	0.634	0.572	-
30	0.549	0.543	0.464	0.580	0.340	0.498	0.668	0.590	i
35	0.566	0.546	0.448	0.574	0.341	0.498	0.711	0.610	-
40	0.586	0.549	0.433	0.568	0.394	0.499	0.767	0.629	-
45	0.615	0.548	0.415	0.563	0.387	0.501	0.832	0.646	-
50	0.657	0.539	0.390	0.562	0.407	0.502	0.934	0.681	-

i – noticeable sweep of west purlin

#### Failure Description:

- Failure of east purlin at 54.7 kips. Failure was sudden. Appeared to be a weak axis column type of failure. Clips slid within the panel seam. Stiffener lip and flange buckle occurred at midspan.

Test No.: A3Witness: JASTest Date: 12/27/00

Strain Gage Readings					
Load (kips)	Gage 1 ( $\mu\epsilon$ )	Gage 2 ( $\mu\epsilon$ )	Gage 3 ( $\mu\epsilon$ )	Gage 4 ( $\mu\epsilon$ )	Comments
0	-1	-2	-2	-2	-
2	-15	-24	-19	-20	-
4	-36	-47	-41	-44	-
6	-56	-71	-65	-65	-
8	-77	-95	-87	-85	-
10	-102	-117	-109	-106	-
15	-158	-174	-183	-167	-
20	-216	-232	-232	-215	-
25	-284	-292	-293	-270	-
30	-340	-346	-349	-325	-
35	-393	-404	-411	-375	-
40	-447	-458	-466	-431	-
45	-510	-515	-523	-487	-
50	-580	-570	-585	-550	-

Test No.: A4Witness: JASTest Date: 12/29/00

Dial Gage Readings									
Load	$\Delta 1$	$\Delta 2$	$\Delta 3$	$\Delta 4$	$\Delta 5$	$\Delta 6$	$\Delta 7$	$\Delta 8$	Comments
(kips)	(in.)	(in.)	(in.)	(in.)	(in.)	(in.)	(in.)	(in.)	
0	0.506	1.642	0.698	0.843	0.482	0.376	0.397	0.393	-
2	0.504	1.642	0.698	0.844	0.478	0.375	0.419	0.397	-
4	0.507	1.642	0.698	0.848	0.477	0.373	0.448	0.404	-
6	0.510	1.642	0.696	0.850	0.481	0.371	0.483	0.410	-
8	0.514	1.642	0.682	0.859	0.486	0.370	0.521	0.417	-
10	0.523	1.640	0.680	0.864	0.485	0.368	0.560	0.424	-
12	0.531	1.638	0.670	0.871	0.486	0.365	0.605	0.428	-
14	0.542	1.634	0.662	0.881	0.488	0.360	0.658	0.429	-
16	0.554	1.628	0.654	0.892	0.493	0.355	0.718	0.419	-
18	0.569	1.620	0.632	0.920	0.506	0.345	0.793	0.388	i

i – Multiple sine wave buckles along entire length of purlin web

Failure Description:

- Failure of east purlin at 21 kips. Appeared to be a weak axis column type of failure.

Clips slid within the panel seam. Stiffener lip buckled as purlin translated laterally.

Test No.: A4Witness: JASTest Date: 12/29/00

Strain Gage Readings					
Load (kips)	Gage 1 ( $\mu\epsilon$ )	Gage 2 ( $\mu\epsilon$ )	Gage 3 ( $\mu\epsilon$ )	Gage 4 ( $\mu\epsilon$ )	Comments
0	-4	-1	-2	-3	-
2	-30	-41	-28	-43	-
4	-65	-78	-58	-83	-
6	-101	-116	-89	-123	-
8	-136	-155	-123	-166	-
10	-172	-192	-156	-206	-
12	-208	-230	-188	-250	-
14	-245	-267	-223	-284	-
16	-289	-305	-264	-323	-
18	-345	-335	-309	-364	-

Test No.: F1Witness: JASTest Date: 8/25/00

Manometer “H <sub>2</sub> O	Pressure (psf)	$\Delta V_{\text{east}}$ (in.)	$\Delta V_{\text{west}}$ (in.)	$\Delta H$ (in.)	Comments
0.0	0.0	0.00	0.00	0.00	-
1.0	5.2	0.72	0.72	0.20	-
1.5	7.8	0.97	0.95	0.30	-
2.0	10.4	1.40	1.32	0.40	-
2.5	13.0	1.73	1.67	0.50	-
3.0	15.6	2.09	1.97	0.60	-
3.5	18.2	2.57	2.40	0.78	-
4.0	20.8	2.98	2.82	0.90	-
4.5	23.4	3.33	3.22	1.04	-
5.0	26.0	4.07	3.87	1.42	-
5.5	28.6	-	-	-	Max.

## Failure Description:

- Purlin rolled and clips sheared. Failure of east purlin. Flanges oriented to the west.

Test No.: F2Witness: JASTest Date: 1/5/01

Manometer “H <sub>2</sub> O	Pressure (psf)	$\Delta V_{\text{east}}$ (in.)	$\Delta V_{\text{west}}$ (in.)	$\Delta H$ (in.)	Comments
0.0	0.0	0.00	0.00	0.00	-
1.0	5.2	0.76	0.68	0.23	-
1.5	7.8	1.16	1.10	0.36	-
2.0	10.4	1.66	1.48	0.44	-
2.5	13.0	2.01	1.93	0.55	-
3.0	15.6	2.26	2.26	0.65	-
3.5	18.2	2.58	2.74	0.73	-
4.0	20.8	2.95	3.10	0.81	-
4.5	23.4	3.35	3.67	0.99	-
5.0	26.0	-	-	-	Max.

## Failure Description:

- Failure of west purlin, flanges oriented toward west. Web and flange buckle at purlin midspan.

Test No.: F3Witness: Scott CorteseTest Date: 7/20/00

Manometer “H <sub>2</sub> O	Pressure (psf)	$\Delta V_{\text{eave}}$ (in.)	$\Delta V_{\text{ridge}}$ (in.)	$\Delta H$ (in.)	Comments
0.000	0.000	0.000	0.000	0.000	-
1.049	5.455	0.488	0.406	0.077	-
1.518	7.894	0.737	0.651	0.132	-
2.108	10.962	1.012	0.912	0.232	-
2.503	13.016	1.200	1.083	0.294	-
3.231	16.801	1.559	1.398	0.455	-
3.585	18.642	1.720	1.534	0.473	-
4.027	20.940	1.952	1.723	0.519	-
4.529	23.551	2.272	1.982	0.624	-
5.012	26.062	2.578	2.243	0.728	-
5.545	28.834	2.996	2.669	0.967	-
6.020	31.304	3.288	2.914	0.974	-
6.517	33.888	3.792	3.355	1.029	-
7.022	36.514	4.445	3.909	1.092	-
7.519	39.099	5.111	4.581	1.115	-
7.983	41.512	6.683	5.493	0.994	-

## Failure Description:

- Lateral Torsional inelastic buckling of flange and web at maximum moment region. Maximum pressure = 7.98 “H<sub>2</sub>O.



Test No.: F4Witness: Scott CorteseTest Date: 7/17/00

Manometer	Pressure	$\Delta V_{\text{eave}}$	$\Delta V_{\text{ridge}}$	$\Delta H$	Comments
"H <sub>2</sub> O	(psf)	(in.)	(in.)	(in.)	
0.000	0.000	0.000	0.000	0.000	-
1.077	5.236	0.701	0.602	0.036	-
1.500	7.800	1.009	0.903	0.137	-
2.186	11.367	1.484	1.332	0.246	-
2.538	13.198	1.728	1.534	0.287	-
3.017	15.688	2.095	1.832	0.378	-
3.515	18.278	2.538	2.229	0.528	-
4.008	20.842	3.047	2.778	0.728	-
4.459	23.187	3.872	4.163	0.928	-

## Failure Description:

- Lateral torsional inelastic buckling of flange and web at maximum moment region. Maximum pressure = 4.46 "H<sub>2</sub>O.

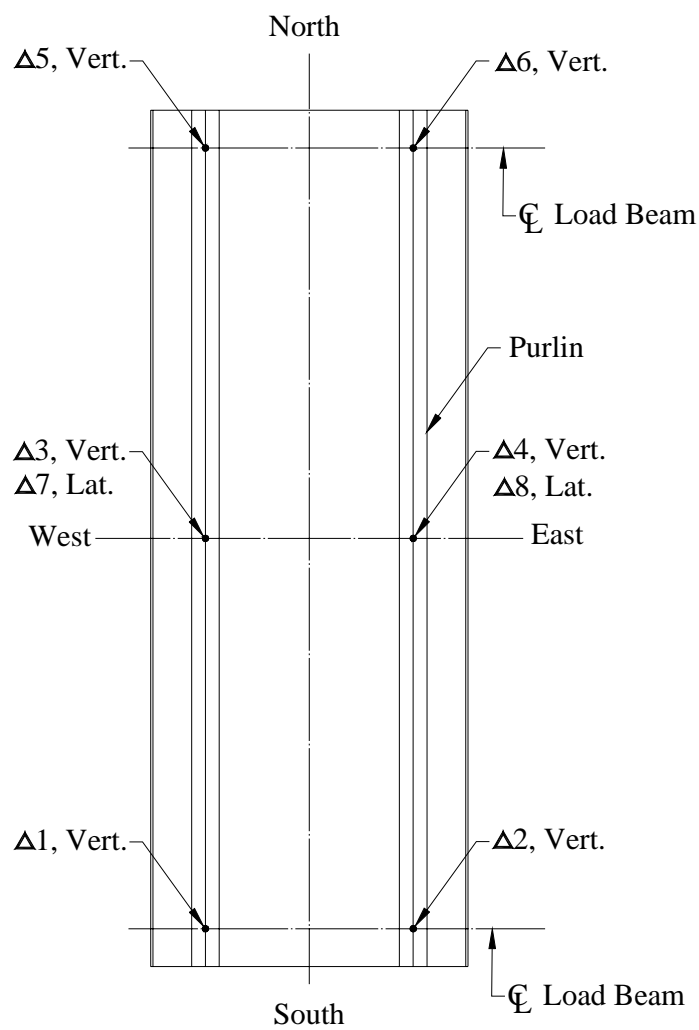

Figure 41: Location of Dial Gages

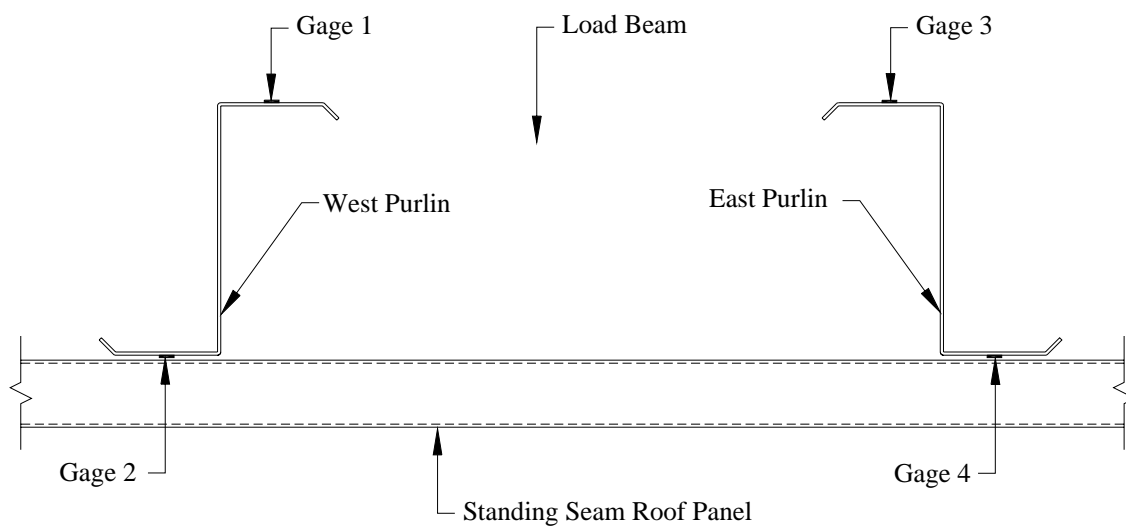

Figure 42: Location of Stain Gages

**APPENDIX 6: SAMPLE CALCULATIONS FOR AXIAL LOAD CORRECTION**

TEST #1: Test Correction

- To obtain the pure axial load capacity of the standing seam roof assembly two corrections need to be made. The first correction accounts for the bending moment in the purlin. The bending moment results from numerous things such as load eccentricity, camber, which produces P-Δ moments, and moment due to the self-weight of the assembly. Through the use of strain gages, the moment in the purlin is calculated and can be back calculated into an equivalent axial load. The second correction that needs to be made results from the end fixity at the test fixture. The end fixity, when modeled with finite elements, resulted in up to a 25 percent increase in axial load capacity. Field conditions do not have this end fixity, therefore the experimental loads are reduced by 25 percent.

## Strain Gage Readings: West Purlin

Readings at 60 kips:  $\epsilon_5 = -663 \mu\epsilon$  (micro-strain)

$$\epsilon_6 = -533 \mu\epsilon$$

$$\epsilon_{ave} = \frac{\epsilon_5 + \epsilon_6}{2} = \frac{-663 + (-533)}{2} = -598 \mu\epsilon$$

Determine the moment in the purlin:

$$\epsilon_{mom} = -663 - (-598) = -65 \mu\epsilon$$

$$\text{Flexural Stress} = E(\epsilon) = 29,500(65 \times 10^{-6}) = 1.92 \text{ ksi}$$

$$S_{xeff} = 4.1591 \text{ in}^3$$

$$M = f_b S_{xeff} = 1.92(4.1591) = 8 \text{ K-in.}$$

Interaction Equation:

$$\frac{P_{Test}}{P_{All}} + \frac{M_{Test}}{M_{All}} = 1.0$$

$$P_{test} = 31.05 \text{ kips}$$

$$M_{all} = 123.2 \text{ K-in. (results of uplift base test)}$$

$$\frac{31.05}{P_{All}} + \frac{8}{123.2} = 1.0$$

$$P_{All} = \frac{31.05}{\left(1.0 - \frac{8}{123.2}\right)} = 33.2 \text{ kips}$$

Lastly, to correct for the end fixity:

$$P_{corrected} = 0.75P_{all} = 0.75(33.2) = 24.9 \text{ kips}$$

**APPENDIX 7: PROPOSED DESIGN APPROACH AND EXAMPLE**

The recommendations included in Chapter 5 are intended to be used in conjunction with the results obtained from flexural uplift tests conducted in conformance with the Base Test Method prescribed in the AISI Cold-Formed Specification<sup>10</sup>.

The following is proposed as an addition to the current AISI Cold-Formed Specification and is written according to the current AISI Specification standards.

#### **C4.5 Compression Members Having One Flange Fastened to Standing Seam Roof**

These provisions are applicable to Z-sections concentrically loaded along their longitudinal axis, with only one flange attached to standing seam roof panels. Alternatively, design values for a particular system shall be permitted to be based on tests according to Section F.

The nominal axial strength of simple span or continuous Z-sections shall be calculated as follows:

(a) For weak axis nominal strength

$$P_n = k_{af} R F_y A \quad \text{kips (Newtons)} \quad (\text{Eq. C4.5-1})$$

$$\Omega = 1.80 \text{ (ASD)}$$

$$\phi = 0.85 \text{ (LRFD)}$$

where:

$$k_{af} = 0.36 \text{ for } \frac{d}{t} \leq 90 \quad (\text{Eq. C4.5-2})$$

$$0.72 - \frac{d}{250t} \text{ for } 90 < \frac{d}{t} \leq 130 \quad (\text{Eq. C4.5-3})$$

$$0.20 \text{ for } \frac{d}{t} > 130 \quad (\text{Eq. C4.5-4})$$



R = The reduction factor determined by the “Base Test Method for Purlins Supporting a Standing Seam Roof System” of Part VIII of the AISI Cold-Formed Steel Design Manual.

A = The full unreduced cross-sectional area of the Z-section.

F<sub>y</sub> as defined in Section C3.1.1

Eq. C4.5-1 shall be limited to roof systems meeting the following conditions:

- (1) Purlin thickness not exceeding 0.125-inches (3.22 mm)
- (2) 6-inches (152 mm) ≤ d ≤ 12-inches (305 mm)
- (3) Flanges are edge stiffened compression elements
- (4)  $70 \leq \frac{d}{t} \leq 170$
- (5)  $2.8 \leq \frac{d}{b} < 5$
- (6)  $16 \leq \frac{\text{flange flat width}}{t} < 50$
- (7) Both flanges are prevented from moving laterally at the supports

(b) For strong axis nominal strength, the equations contained in Section C4 and C4.1 of the Specification shall be used.

The following is proposed as an addition to the Commentary of the current AISI Cold-Formed Specification and is written according to the current AISI Specification standards.

#### **C4.5 Compression Members Having One Flange Fastened to Standing Seam Roof**

For axially loaded Z-sections having one flange attached to standing seam roof panels and the other unbraced, e.g., a roof purlin subjected to wind or seismic generated compression forces, the axial load capacity is less than a fully braced member, but greater than an unbraced member. The partial restraint against weak axis buckling is a function of the rotational stiffness provided by the panel-to-purlin connection. Specification Equation C4.5-1 is used to calculate the weak axis capacity. The equation developed by Stolarczyk (2001) is empirically based.

A limitation on the maximum yield point of the Z-section is not given in the Specification since Equation C4.5-1 is based on elastic buckling criteria. A limitation on minimum length is not contained in the Specification because Equation C4.5-1 is conservative for spans which are smaller than that tested under the Base Test provisions.

As indicated in the Specification, the strong axis axial load capacity is determined assuming that the weak axis of the strut is braced.

The controlling axial load capacity (weak or strong axis) is suitable for usage in the combined axial load and bending equations in Section C5 of the Specification (Hatch, Easterling, and Murray, 1990).

**DESIGN EXAMPLE**

Given:

Purlin Geometry:

- Thickness = 0.082-inches
- Flange Width = 2.5-inches
- Depth = 8.5-inches
- Gross Area,  $A_g = 1.21 \text{ in}^2$

Strength Characteristics:

- Minimum Yield Strength,  $F_y = 55 \text{ ksi}$
- R based on AISI Base Test Method for Uplift of 0.60.

Problem Statement: Determine the nominal weak axis axial load capacity of the given purlin supporting a standing seam roof system.

$$\text{Calculate } \frac{d}{t} = \frac{8.5}{0.082} = 103.7$$

Since this is between 90 and 130 use

$$\begin{aligned} k_{af} &= 0.72 - \frac{d}{250t} && \text{Equation 2, Chapter 5} \\ &= 0.72 - \frac{8.5}{(250)(0.082)} \\ &= 0.31 \end{aligned}$$

Calculate the axial stress:

$$\begin{aligned} F_a &= k_{af} R F_y \\ &= 0.31(0.60)(55) \\ &= 10.2 \text{ ksi} \end{aligned}$$

Nominal Weak Axis Axial Load Capacity of Purlin:

$$\begin{aligned} P_n &= F_a A_g \\ &= 10.2(1.21) \\ &= 12.3 \text{ kips} \end{aligned}$$

Use  $\Omega = 1.80$  (ASD)

$$\phi = 0.85 \text{ (LRFD)}$$

Therefore, the weak axis design axial load capacity of the given system is:

For ASD:

$$\begin{aligned} P_a &= \frac{P_n}{\Omega} \\ &= \frac{12.3}{1.80} \\ &= 6.8 \text{ kips} \end{aligned}$$

For LRFD:

$$\begin{aligned} P_a &= \phi P_n \\ &= 0.85(12.3) \\ &= 10.5 \text{ kips} \end{aligned}$$

The strong axis nominal axial strength must be checked separately. For this check, the equations contained in Section C4 and C4.1 of the AISI Specification shall be used.



**American Iron and Steel Institute**

1140 Connecticut Avenue, NW  
Suite 705  
Washington, DC 20036

[www.steel.org](http://www.steel.org)

