

01 Oct 2009

Steel sheet sheathing options for cold-formed steel framed shear wall assemblies providing shear resistance - phase 2

Cheng Yu

Yujie Chen

Follow this and additional works at: <https://scholarsmine.mst.edu/ccfss-library>



Part of the [Structural Engineering Commons](#)

Recommended Citation

Yu, Cheng and Chen, Yujie, "Steel sheet sheathing options for cold-formed steel framed shear wall assemblies providing shear resistance - phase 2" (2009). *Center for Cold-Formed Steel Structures Library*. 92.

<https://scholarsmine.mst.edu/ccfss-library/92>

This Technical Report is brought to you for free and open access by Scholars' Mine. It has been accepted for inclusion in Center for Cold-Formed Steel Structures Library by an authorized administrator of Scholars' Mine. This work is protected by U. S. Copyright Law. Unauthorized use including reproduction for redistribution requires the permission of the copyright holder. For more information, please contact scholarsmine@mst.edu.

research report

Steel Sheet Sheathing Options for Cold-Formed Steel Framed Shear Wall Assemblies Providing Shear Resistance - Phase 2

RESEARCH REPORT RP09-2

2009



American Iron and Steel Institute



Steel Framing Alliance™

Steel. The Better Builder.

DISCLAIMER

The material contained herein has been developed by researchers based on their research findings and is for general information only. The information in it should not be used without first securing competent advice with respect to its suitability for any given application. The publication of the information is not intended as a representation or warranty on the part of the American Iron and Steel Institute, Steel Framing Alliance, or of any other person named herein, that the information is suitable for any general or particular use or of freedom from infringement of any patent or patents. Anyone making use of the information assumes all liability arising from such use.

PREFACE

The *North American Standard for Cold-Formed Steel Framing - Lateral Design*, AISI S213-07, provides design provisions for cold-formed steel framed shear walls with steel sheet sheathing. However, options are limited to 18-mil and 27-mil steel sheet sheathing.

Phase 1 of this project was successfully completed and a final report, *Steel Sheet Sheathing Options for Cold-Formed Steel Framed Shear Wall Assemblies Providing Shear Resistance*, dated October 31, 2007 has been issued. The primary objective of Phase 1 was to add values to AISI S213 for 30-mil and 33-mil sheet steel shear walls with 2:1 and 4:1 aspect ratios and 6", 4", 3" and 2" fastener spacing at panel edges, and 27-mil sheet steel shear walls with 2:1 aspect ratio and 6", 4", 3" and 2" fastener spacing at panel edges. A further objective of Phase 1 was to verify the deflection equations in AISI S213 and develop new equations, if needed. An apparent discrepancy in the test results of Phase 1 when compared to previous work by other researchers necessitated this Phase 2 project.

The objective of Phase 2 was to verify and, if warranted, propose revised values in AISI S213 for 18-mil sheet steel shear walls with 2:1 aspect ratio and 6" fastener spacing at panel edges; and 27-mil sheet steel shear walls with 4:1 aspect ratio and 6", 4", 3" and 2" fastener spacing at panel edges. A further objective of Phase 2 was to determine special seismic detailing requirements, if any, needed to assure satisfactory performance of a 6'-wide sheet steel shear wall with a 2'-wide and a 4'-wide panel. Presented in this report are the findings from the monotonic and cyclic testing program that was conducted at the University of North Texas.

It is anticipated that the results of this study will be incorporated in future standards developed by the AISI Committee on Framing Standards and design aids developed by the Cold-Formed Steel Engineers Institute.



**Steel Sheet Sheathing Options for Cold-Formed Steel Framed
Shear Wall Assemblies Providing Shear Resistance – Phase 2**

Report No. UNT-G70752

By

Cheng Yu, PhD
Assistant Professor

Yujie Chen
Research Assistant

A Research Report Submitted to American Iron and Steel Institute

October 29, 2009

Department of Engineering Technology
University of North Texas
Denton, Texas 76207

ABSTRACT

Monotonic and cyclic tests on cold-formed steel shear walls sheathed with steel sheets on one side were conducted to (1) verify the published nominal shear strength for 18-mil and 27-mil steel sheets; and (2) investigate the behavior of 6-ft. wide shear walls with multiple steel sheets. This project is the continuation of a completed project titled “Steel Sheet Sheathing Options for Cold-Formed Steel Framed Shear Wall Assemblies Providing Shear Resistance” by Yu (2007). This Phase 2 project confirms the discrepancy in the published nominal strength of 27-mil sheets discovered by the Phase 1 project, and proposes new values. The project also finds disagreement on the nominal strength of 18-mil sheets for seismic design, which requires further research. For the 6-ft. wide shear walls, this project identifies special seismic detailing to prevent potential damage on studs while improving the strength and ductility of the shear walls. This report provides detailed information on the test setup, test results, and analyses.

Table of Contents

Background and Objectives	1
Test Program	3
Test Setup.....	3
Test Procedure.....	5
Test Specimens.....	8
Material Properties.....	21
Test Results and Discussion	22
Task 1 – Verifying nominal strength of 27-mil and 18-mil sheet steel shear walls	22
Task 2 – Special detailing for 8-ft. × 6-ft. shear walls sheathed with steel sheets	28
Conclusions and Future Research	42
Acknowledgement	43
References	43
Appendix A Data Sheets for Task 1 Tests	45
Appendix B Data Sheets for Task 2 Tests	70

BACKGROUND AND OBJECTIVES

The American Iron and Steel Institute (AISI) “North American Standard for Cold-Formed Steel Framing – Lateral Design 2007 Edition” (AISI S213, 2007) provides shear strengths for a limited range of options of the sheathing thickness and the wall aspect ratio for cold-formed steel framed walls with steel sheet sheathing. Therefore, in 2007 Yu performed a research project titled “Steel Sheet Sheathing Options for Cold-Formed Steel Framed Shear Wall Assemblies Providing Shear Resistance” (Phase 1). The main objective of Phase 1 research was to determine the nominal shear strength for 30-mil and 33-mil steel sheet sheathed shear walls with 2:1 and 4:1 aspect ratios and 6”, 4”, 3”, and 2” fastener spacing at panel edges, and 27-mil steel sheet sheathed shear walls with 2:1 aspect ratio and 6”, 4”, 3”, and 2” fastener spacing at panel edges.

The test results of Phase 1 on 27-mil sheet steel shear walls demonstrated different than the ones published in AISI S213 (2007). Although the AISI values were for walls with an aspect ratio of 4:1 while the Phase 1 tests were on walls with a ratio of 2:1, the Phase 1 work indicted that walls with 4:1 and 2:1 aspect ratio yield close shear resistance per unit width. AISI S213 values were based on Serrette (1997). Serrette (2002) also conducted cyclic tests on 27-mil sheet steel shear walls with simple lap connected sheathing. Tables 1 and 2 summarize the test results of Serrette (1997, 2002). Table 3 summarizes the test results of Phase 1 research (Yu 2007).

Table 1 Test matrix and results of steel sheet shear walls in Serrette 1997

Monotonic Tests				
Configuration	Sheathing Thickness (in.)	#8 Screw Spacing edge (in.)/field(in.)	Wall Aspect Ratio (h:w)	Nominal Shear Strength (plf)
1	0.018	6/12	4:1 (8 ft × 2 ft)	491
2	0.018	6/12	2:1 (8 ft × 4 ft)	483
3	0.027	4/12	4:1 (8 ft × 2 ft)	990
Cyclic Tests				
1	0.018	6/12	2:1 (8 ft × 4 ft)	392
2	0.027	4/12	4:1 (8 ft × 2 ft)	1003
3	0.027	2/12	4:1 (8 ft × 2 ft)	1171
All specimens used nominal 33 ksi yield strength material, SSMA 350S162-33 studs, SSMA 350T125-33 track, and No.8 × ½-inch self-drilling screws. Two identical tests were conducted for each configuration, the average values are reported here.				

Table 2 Test matrix and results of steel sheet shear walls in Serrette 2002

Cyclic Tests				
Configuration	Sheathing thickness (in.)	#8 Screw spacing edge (in.)/field(in.)	Wall aspect ratio (h:w)	Nominal shear strength (plf)
1	0.027	2/12	2:1 (8 ft × 4 ft)	787
All specimens used nominal 33 ksi yield strength material, SSMA 350S162-33 studs, SSMA 350T125-33 track, and No.8 × ½-inch self-drilling screws. Two identical tests were conducted for each configuration, the average values are reported here. 1.5 in. lap joint at wall mid height with single line of fasteners.				

Table 3 Test matrix and results of 27-mil steel sheet shear walls in Phase 1

Configuration	Sheathing thickness (in.)	#8 Screw spacing edge (in.)/field(in.)	Wall aspect ratio (h:w)	Nominal shear strength (plf)
Monotonic Tests				
1	0.027	2/12	2:1 (8 ft × 4 ft)	836
2	0.027	4/12	2:1 (8 ft × 4 ft)	684
3	0.027	6/12	2:1 (8 ft × 4 ft)	626
Cyclic Tests				
1	0.027	2/12	2:1 (8 ft × 4 ft)	845
2	0.027	4/12	2:1 (8 ft × 4 ft)	710
3	0.027	6/12	2:1 (8 ft × 4 ft)	647
All specimens used nominal 33 ksi yield strength material, SSMA 350S162-33 studs, SSMA 350T150-33 track, and No.8 × ½-inch self-drilling screws. Two identical tests were conducted for each configuration, the average values are reported here.				

Tables 1, 2, and 3 show that differences in the nominal shear strength of 27-mil steel sheet shear walls are as large as 29% between Phase 1 tests and AISI values (Table 1) as the reference. Therefore, these differences between 27-mil sheet steel shear wall strengths should be investigated and the published nominal shear strength values in current AISI S213 (2007) verified.

The existing experimental studies of cold-formed steel shear walls (Serrette 1996, 1997, 2002; Yu 2007) have been focused on wall aspect ratios 2:1 and 4:1, in which one sheet of sheathing was usually installed, and one or no interior stud was used. However in the actual application, shear walls with a larger aspect ratio less than 2:1 are frequently used. For those wider shear walls, multiple sheets of sheathing will be installed and more than one interior studs will be used to support the gravity loads and other demands. Therefore consideration shall be given to the sheathing joint and the framing details to ensure satisfactory performance of the shear walls in the events of earthquakes and strong winds.

The objective of the Phase 2 research is (1) to verify and if warranted, propose revised shear strength values in AISI S213 for 18-mil sheet steel walls with 2:1 aspect ratio and 6" fastener spacing at panel edges; and 27-mil sheet steel shear walls with 4:1 aspect ratio and 6", 4", 3", and 2" fastener spacing at panel edges; (2) to determine seismic detailing requirements to assure satisfactory performance of a 6'-wide steel shear wall with a 2'-wide and a 4'-wide steel sheet sheathing.

TEST PROGRAM

The test program was carried out from September 2008 to July 2009 in the NUCONSTEEL Materials Testing Laboratory at the University of North Texas, Denton Texas. The research completed two tasks. Task 1 verified the published nominal shear strength of 27-mil and 18-mil sheet steel shear walls and if discrepancy was warranted, proposed revised nominal strength. Task 2 investigated the behavior and identified required detailing to achieve satisfactory performance of 6-ft. wide steel sheet shear walls in seismic loads.

Test Setup

The monotonic tests and the cyclic tests were performed on a 16-ft. span, 12-ft. high adaptable structural steel testing frame. Figure 1 shows the front view of the testing frame with an 8-ft. × 4-ft. steel shear wall installed. All the shear wall specimens were assembled in a horizontal position and then installed vertically in the testing frame. The wall is bolted to the base beam and loaded horizontally at the top. For shear walls using 3.5-in. framing members, a 5-in. × 5-in. × ½-in. structural steel tubing was used for the base beam. For shear walls using 6-in. framing members, 10-in. × 5-in. × ½-in. structural steel tubing was used for the base beam. The base beam was attached to a W16×67 structural steel beam that was attached to the concrete floor slab with ¾-in. anchor bolts at 24-in. in the center. The web of the structural steel tubing base beam was cut-out in several locations on one side to provide access to anchor bolts in the shear walls.

The lateral force was applied to the shear wall top via a load beam made of structural steel T shape. The T shape was attached to the top track of the shear wall by 2 - No. 12 × 1-1/2-in. hex washer head (HWH) self-drilling tapping screws placed every 3-in. on center. The out-of-plane displacement of the wall was prevented by a series of steel rollers on each side of the T shape. A gap of approximately 1/8-in. was provided between the rollers and the T shape to avoid significant friction in the test. The anchorage system for monotonic tests consisted of ASTM A490 5/8-in. diameter shear anchor bolts with standard cut washers (ASME B18.22.1 (1998)) and one Simpson Strong-Tie® S/HD10 hold-down with one ASTM A490 5/8-in. diameter anchor bolt. For the cyclic tests, the anchorage system included ASTM A490 5/8-in. diameter shear anchor bolts and one Simpson Strong-Tie® S/HD10 hold-down with a 5/8-in. diameter ASTM A490 anchor bolt at each end of the shear wall.

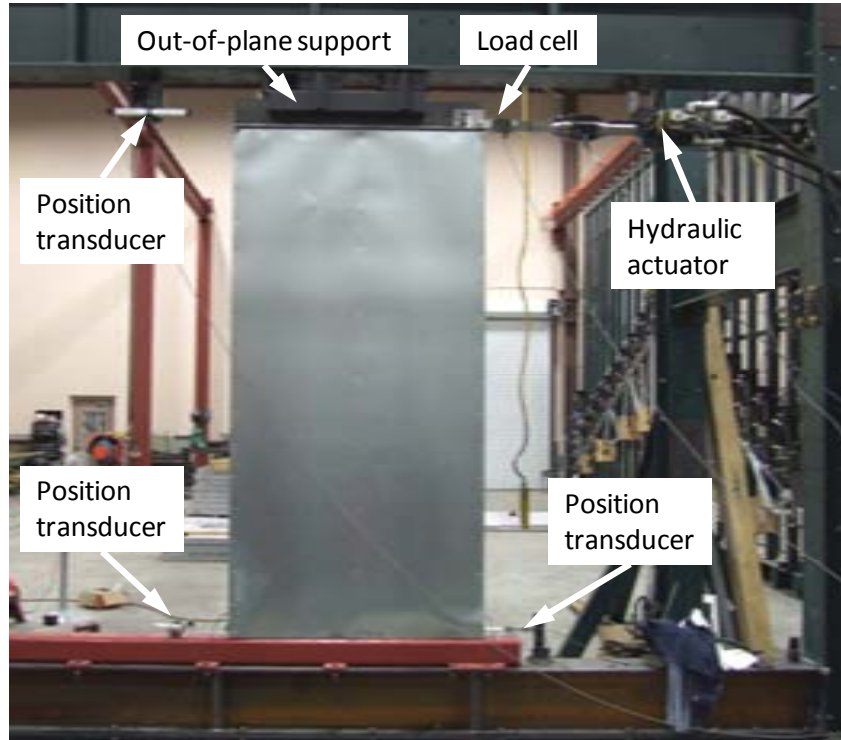

Figure 1 Front view of the test setup

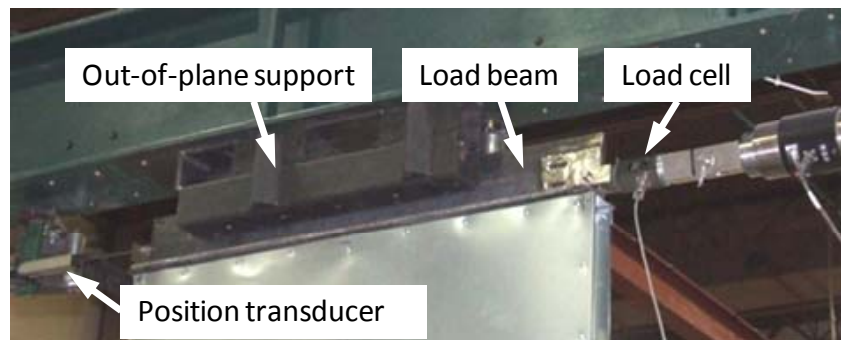

Figure 2 Close up of the top of the wall specimen

The testing frame was equipped with one MTS[®] 35-kip hydraulic actuator with ± 5 -in. stroke. A MTS[®] 407 controller and a 20-GPM MTS[®] hydraulic power unit were employed to support the loading system. A 20-kip TRANSDUCER TECHNIQUES[®] SWO universal compression/tension load cell was placed to pin-connect the actuator rod to the T shape. Five NOVOTECHNIC[®] position transducers were employed to measure the horizontal displacement at the top of wall, and the vertical and horizontal displacements of the bottoms of the two boundary studs. The data acquisition system consisted of a National Instruments[®] unit (including a PCI6225 DAQ card, a SCXI1100 chassis with SCXI1520 load cell sensor module and SCXI1540 LVDT input module) and an IBM[®] desktop. The applied force and the five displacements were measured and recorded instantaneously during the test.

Test Procedure

Both the monotonic and the cyclic tests were conducted in a displacement control mode. The procedure of the monotonic tests was in accordance with ASTM E564 (2006) “Standard Practice for Static Load Test for Shear Resistance of Framed Walls for Buildings.” A preload of approximately 10% of the estimated ultimate load was applied first to the specimen and held for 5 minutes to seat all connections. After the preload was removed, the incremental loading procedure followed until structural failure was achieved using a load increment of 1/3 of the estimated ultimate load.

Two protocols were used for the cyclic tests as specified in Tables 4 and 5: (1) Sequential Phased Displacement, SPD, protocol used in Serrette (1997), and (2) The CUREE protocol, in accordance with the method C in ASTM E2126 (2007) “Standard Test Methods for Cyclic (Reversed) Load Test for Shear Resistance of Vertical Elements of the Lateral Force Resisting Systems for Buildings.” Table 4 and Figure 3 illustrate the basic displacement history of the SPD protocol with 0.2-Hz loading frequency. The SPD protocol used in Serrette (1997) includes 54 cycles.

Table 4 SPD basic displacement history used by Serrette (1997)

No. of Cycles	Input Displacement, in.	No. of Cycles	Input Displacement, in.
3	0.2	3	1.6
3	0.4	1	2.0
3	0.6	1	1.5
3	0.8	1	1.0
1	1.0	1	0.5
1	0.75	3	2.0
1	0.50	1	2.4
1	0.25	1	1.8
3	1.0	1	1.2
1	1.2	1	0.6
1	0.9	3	2.4
1	0.6	1	2.8
1	0.3	1	2.1
3	1.2	1	1.4
1	1.6	1	0.7
1	1.2	3	2.8
1	0.8		
1	0.4		

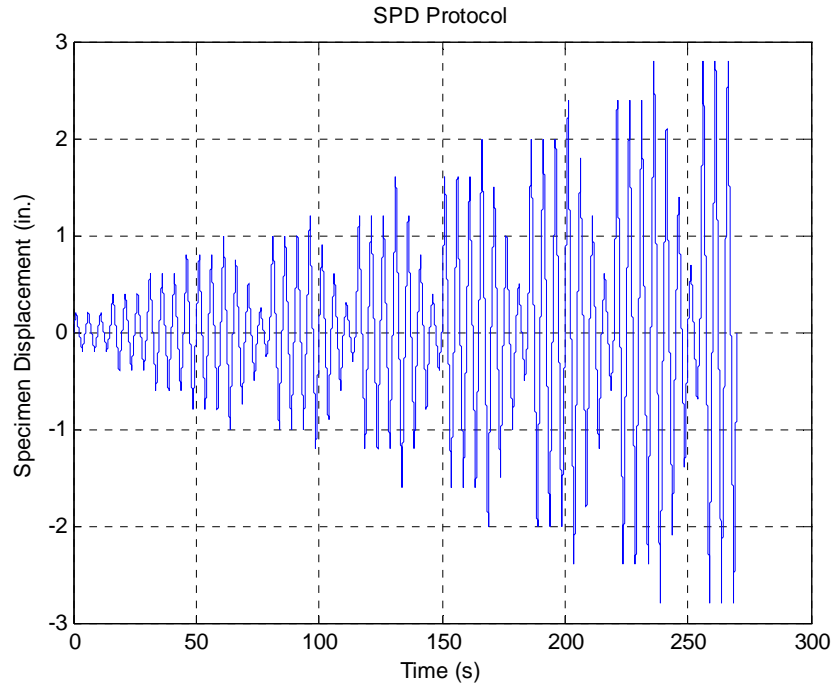

Figure 3 SPD basic loading history (0.2 Hz)

The CUREE protocol was chosen for the majority of cyclic tests in the Phase 2 research. The CUREE basic loading history shown in Figure 4 includes 40 cycles with specific displacement amplitudes, which are listed in Table 5. The specified displacement amplitudes are based on a percentage of the ultimate displacement capacity determined from the monotonic tests. If the panel has not failed at the end of the 40 cycles of Table 5, then additional cycles shall be added. Each progressive primary cycle added shall include an increase of 50% over the previous primary cycle. Two trailing cycles shall follow each primary cycle with an added magnitude of 75% of the primary cycle.

For both the SPD and the CUREE protocols, a constant cycling frequency of 0.2 Hz for the loading history was adopted in the Phase 2 tests.

Table 5 CUREE basic loading history

CYCLE NO.	%Δ	CYCLE NO.	%Δ
1	5.0	21	20
2	5.0	22	15
3	5.0	23	15
4	5.0	24	15
5	5.0	25	30
6	5.0	26	23
7	7.5	27	23
8	5.6	28	23
9	5.6	29	40
10	5.6	30	30
11	5.6	31	30
12	5.6	32	70
13	5.6	33	53
14	10	34	53
15	7.5	35	100
16	7.5	36	75
17	7.5	37	75
18	7.5	38	150
19	7.5	39	113
20	7.5	40	113

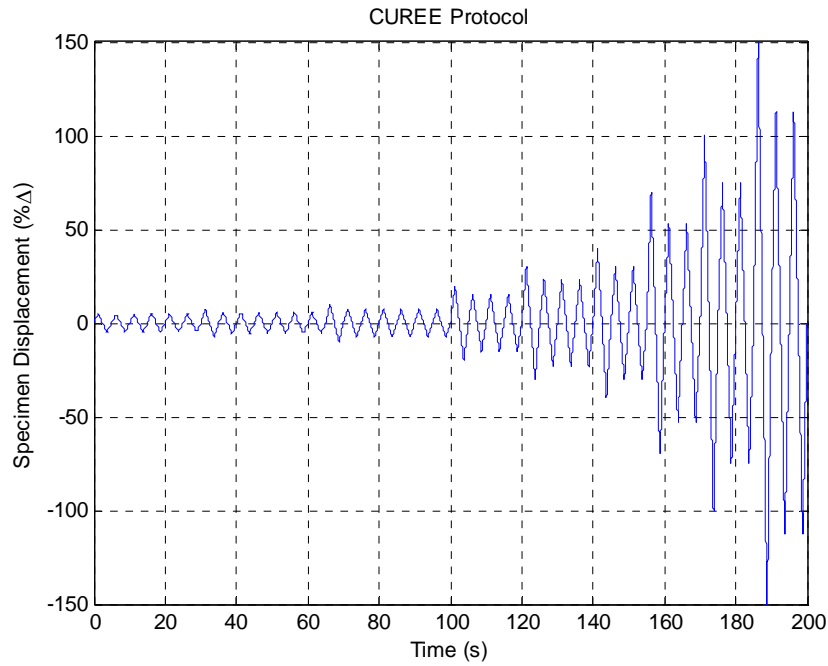

Figure 4 CUREE basic loading history (0.2 Hz)

Test Specimens

Test Specimens for Task 1

The test specimen configurations for Task 1 are listed in Table 6. Task 1 was to verify the published shear strength values for 27-mil and 18-mil sheet steel shear walls in AISI S213 (2007), and propose revised shear strength if discrepancy was observed and confirmed. In order to make direct comparison with the test results of Serrette (1997), the same cyclic test protocol – SPD was used for one 27 mil sheet shear wall with a 4:1 aspect ratio. The majority of the cyclic tests in Table 6 used the CUREE protocol and all the monotonic tests used ASTM E564 (2006), which was same as the Phase 1 research (Yu 2007).

Table 6 Test matrix for Task 1

Test label	Wall dimension h×w (ft. × ft.)	Nominal sheathing thickness (in.)	Nominal framing thickness (in.)	Fastener spacing at panel edges (in.)	Test protocol
8×2×350-33×27-2-C1	8×2	0.027	0.033	2	Cyclic – SPD
8×2×350-33×27-6-M1	8×2	0.027	0.033	6	Monotonic-ASTM E564
8×2×350-33×27-6-M2	8×2	0.027	0.033	6	Monotonic-ASTM E564
8×2×350-33×27-6-C1	8×2	0.027	0.033	6	Cyclic – CUREE
8×2×350-33×27-6-C2	8×2	0.027	0.033	6	Cyclic – CUREE
8×4×350-33×18-6-M1	8×4	0.018	0.033	6	Monotonic-ASTM E564
8×4×350-33×18-6-M2	8×4	0.018	0.033	6	Monotonic-ASTM E564
8×4×350-33×18-6-C1	8×4	0.018	0.033	6	Cyclic – CUREE
8×4×350-33×18-6-C2	8×4	0.018	0.033	6	Cyclic – CUREE
8×2×350-33×27-2-M1	8×2	0.027	0.033	2	Monotonic-ASTM E564
8×2×350-33×27-2-M2	8×2	0.027	0.033	2	Monotonic-ASTM E564
8×2×350-33×27-2-M3	8×2	0.027	0.033	2	Monotonic-ASTM E564
8×2×350-33×27-2-C2	8×2	0.027	0.033	2	Cyclic – CUREE
8×2×350-33×27-2-C3	8×2	0.027	0.033	2	Cyclic – CUREE
<p>Note: No.8×18-1/2-in. modified truss head self-drilling tapping screws were used. Screw spacing was 12 in. in the field of sheathing for all tests.</p>					

The dimensions of the tested shear walls are shown in Figure 5 and 6. The studs were placed 24-in. from the edge, in the center. Double back-to-back studs were used for the boundary, and single stud was used for the interior. The steel sheet sheathing was installed on one side of the wall by No. 8-18×1/2-in. modified truss head self-drilling screws.

The details of the components of the proposed steel sheet walls are given as follows:

Studs:

- 350S162-33 SSMA structural stud, 0.033-in. 3-1/2-in. × 1-5/8-in. made of Grade 33 steel, placed in 24-in. o. c.

Tracks:

- 350T150-33 SSMA structural track, 0.033-in. 3-1/2-in. × 1-1/2-in. made of Grade 33 steel.

Sheathing:

- 0.027-in. thick Grade 33 steel.
- 0.018-in. thick Grade 33 steel.
- Steel sheet was installed on one side of the wall assembly.

Framing and Sheathing Screws:

- No. 8-18×1/2-in. modified truss head self-drilling tapping screws. Spacing at panel edge is listed in Table 6. Spacing in the field of the sheathing is 12-in. for all specimen configurations.

Hold-Downs:

- Simpson Strong-Tie[®] S/HD10 hold-downs with No. 10-16×1-in. HWH self-drilling tapping screws, and with 5/8-in. diameter ASTM A490 anchor bolts. Hold-downs were raised 1.5-in. above the edge of the track flange. One hold-down was installed for each monotonic test, and two were used for each cyclic test.

Shear Anchor Bolts:

- 5/8-in. diameter ASTM A490 anchor bolts with standard cut washers and nuts. Four bolts were used for each wall assembly.

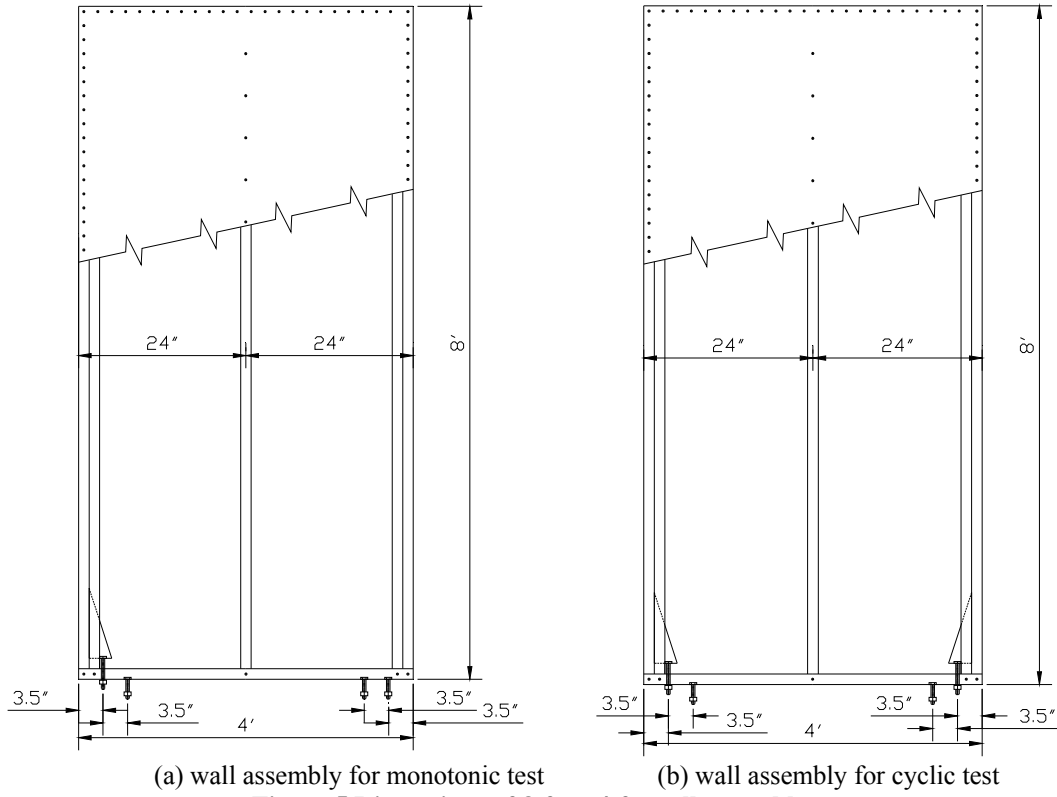

Figure 5 Dimensions of 8-ft. × 4-ft. wall assembly

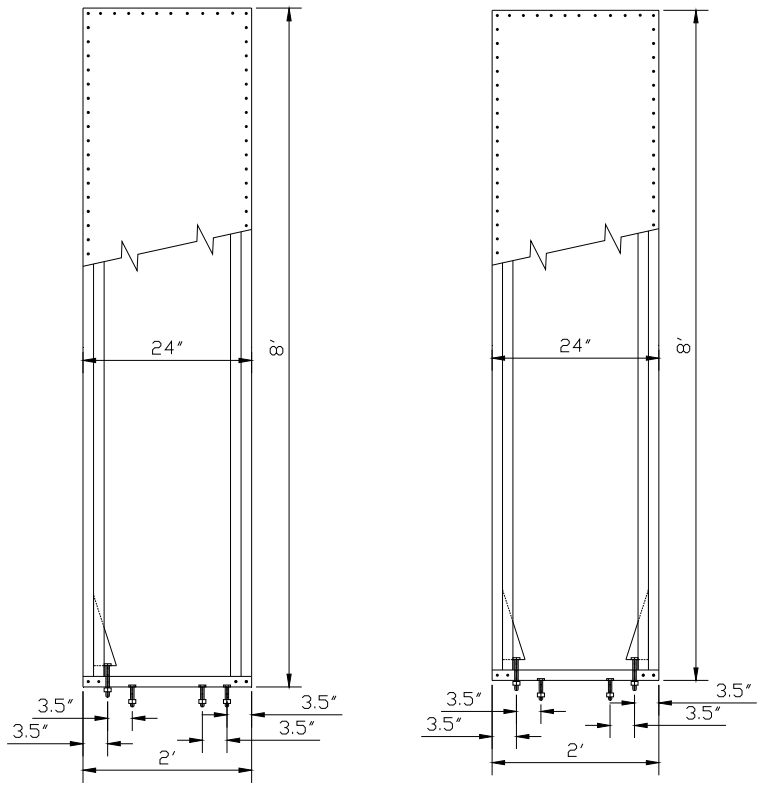

Figure 6 Dimensions of 8-ft. × 2-ft. wall assembly

The vertical gaps between the double boundary studs and the tracks were measured prior to the testing. Figure 7 illustrates the locations of the measured gaps and Table 7 lists the pretest gaps for the specimens for Task 1. The nominal length of the studs and the height of the sheathing are the same, 8-ft., therefore the nominal distance between the sheathing edge and the closest test frame edge is the thickness of the track member plus the gap between the stud and the track at the location in question. The actual distances between the sheathing edge and the test frame edge were not measured. However the test specimens were inspected prior to testing to ensure the sheathing did not extend beyond the framing.

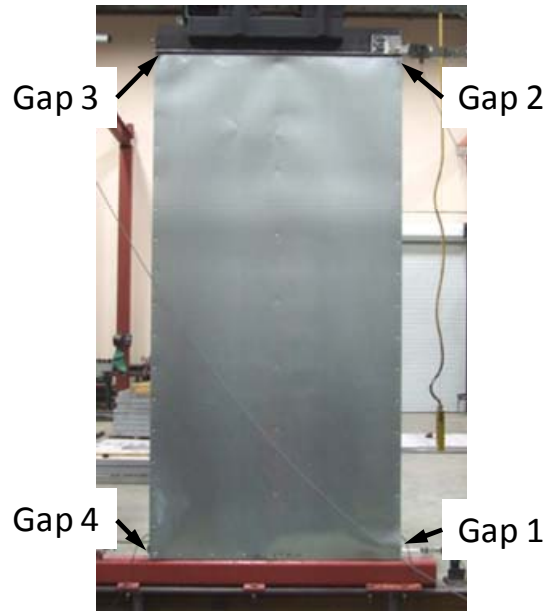

Figure 7 Locations of the measured gaps

Table 7 Measured gaps between boundary studs and tracks of specimens for Task 1

Test label	Gap 1 (in.)	Gap 2 (in.)	Gap 3 (in.)	Gap 4 (in.)
8×2×350-33×27-2-C1	0.115	0.078	0.095	0.068
8×2×350-33×27-6-M1	0.056	0.043	0.056	0.030
8×2×350-33×27-6-M2	0.105	0.078	0.095	0.068
8×2×350-33×27-6-C1	0.112	0.076	0.085	0.168
8×2×350-33×27-6-C2	0.095	0.074	0.068	0.045
8×4×350-33×18-6-M1	0	0.055	0.075	0.120
8×4×350-33×18-6-M2	0.069	0.055	0.093	0.043
8×4×350-33×18-6-C1	0.066	0.056	0.057	0.046
8×4×350-33×18-6-C2	0	0.099	0.136	0
8×2×350-33×27-2-M1	0	0.055	0.093	0
8×2×350-33×27-2-M2	0.106	0.096	0.119	0.178
8×2×350-33×27-2-M3	0.071	0.088	0.096	0.068
8×2×350-33×27-2-C2	0.161	0.092	0.060	0.075
8×2×350-33×27-2-C3	0.040	0.067	0.068	0.068

Test Specimens for Task 2

The details of the test specimens for Task 2 are provided in Table 7. Task 2 was to determine the seismic detailing for 8-ft. × 6-ft. CFS shear walls, therefore the majority of the test specimens in this group were 8-ft. × 6-ft., however 8-ft. × 4-ft. and 8-ft. × 2-ft. shear walls with special detailing were also investigated. Task 2 was focused on the performance of shear walls subject to seismic loads, therefore two identical cyclic tests with CUREE protocol for each specimen configuration were performed. In general, one monotonic test was conducted prior to the cyclic tests. The purpose of the monotonic test was to determine the ultimate displacement capacity which was used to define the reference displacement for the CUREE protocol.

In order to determine the appropriate detailing in framing and the joint of sheathing, a total of 4 wall configurations were used in the test program. Figure 8 shows the wall configuration A. The sheathing consisted of one 8-ft. × 4-ft. and one 8-ft. × 2-ft. steel sheet. The two sheets were butted and attached to the frame by single line of screws at the perimeter and in the field. The studs were 24-in. apart, and double studs were used at the boundary and the sheet joint. One 5/8-in. shear bolt was installed on the bottom trace in each section of the frame. The wall configuration B, illustrated in Figure 9, is similar to the configuration A except that one single stud was installed at the sheet joint.

The wall configuration C, illustrated in Figure 10, was developed from the configuration B with additional special detailing which include the following.

- No. 10-16 × 3/4-in. modified truss head self-drilling tapping screws were used for sheathing and framing. The screws were in single line on tracks and in the stagger pattern at boundary and sheathing joint studs.
- 1-1/2-in. × 33 mil flat strap was installed at the mid height on both sides of the frame. No. 8 × 1/2-in. screws were used to attach the strap to the stud and blocking.
- Stud/track blocking with the same material as the framing members was installed at the mid height in the two end sections of the frame. The strapping and blocking details were in accordance with AISI S230 Standard for Cold-Formed Steel Framing – Prescriptive Method for One and Two Family Dwellings (AISI S230, 2007) Section E, as shown in Figure 11.

The wall configuration C is also used for 8-ft. × 4-ft. and 8-ft. × 2-ft. walls in Task 2. The blocking for the narrow walls is installed continuously along the whole width.

The wall configuration D adopted the same framing detail as configuration B, but used three 8-ft. × 2-ft. steel sheets. The sheets were attached to the frame by single line of screws at the panel edge.

Table 8 Test matrix for Task 2

Test label	Wall dimension height×width (ft. × ft.)	Nominal steel sheet thickness (in.)	Nominal framing web depth (in.)	Nominal framing thickness (in.)	Framing and sheathing fastener	Fastener spacing at panel edges (in.)	Wall config.	Test protocol
8×6×350-43×30-2-C1-A	8×6	0.030	3.5	0.043	#8×1/2"	2	A	Cyclic-CUREE
8×6×350-43×30-2-C1-B	8×6	0.030	3.5	0.043	#8×1/2"	2	B	Cyclic-CUREE
8×6×350-43×33-2-M1-C	8×6	0.033	3.5	0.043	#10×3/4"	2	C	Monotonic-ASTM E564
8×6×350-43×33-2-C1-C	8×6	0.033	3.5	0.043	#10×3/4"	2	C	Cyclic-CUREE
8×6×350-43×33-2-C2-C	8×6	0.033	3.5	0.043	#10×3/4"	2	C	Cyclic-CUREE
8×6×350-43×30-2-M1-C	8×6	0.030	3.5	0.043	#10×3/4"	2	C	Monotonic-ASTM E564
8×6×350-43×30-2-C1-C	8×6	0.030	3.5	0.043	#10×3/4"	2	C	Cyclic-CUREE
8×6×350-43×30-2-C2-C	8×6	0.030	3.5	0.043	#10×3/4"	2	C	Cyclic-CUREE
8×6×600-43×33-2-M1-C	8×6	0.033	6	0.043	#10×3/4"	2	C	Monotonic-ASTM E564
8×6×600-43×33-2-C1-C	8×6	0.033	6	0.043	#10×3/4"	2	C	Cyclic-CUREE
8×6×600-43×33-2-C2-C	8×6	0.033	6	0.043	#10×3/4"	2	C	Cyclic-CUREE
8×6×350-54×33-2-M1-B	8×6	0.033	3.5	0.054	#8×1/2"	2	B	Monotonic-ASTM E564
8×6×350-54×33-2-C1-B	8×6	0.033	3.5	0.054	#8×1/2"	2	B	Cyclic-CUREE
8×6×350-54×33-2-C2-B	8×6	0.033	3.5	0.054	#8×1/2"	2	B	Cyclic-CUREE
8×6×350-43×27-2-M1-D	8×6	0.027	3.5	0.043	#10×3/4"	2	D	Monotonic-ASTM E564
8×6×350-43×27-2-C1-D	8×6	0.027	3.5	0.043	#10×3/4"	2	D	Cyclic-CUREE
8×6×350-54×33-2-M1-C	8×6	0.033	3.5	0.054	#10×3/4"	2	C	Monotonic-ASTM E564
8×6×350-54×33-2-C1-C	8×6	0.033	3.5	0.054	#10×3/4"	2	C	Cyclic-CUREE
8×6×350-54×33-2-C2-C	8×6	0.033	3.5	0.054	#10×3/4"	2	C	Cyclic-CUREE
8×4×350-43×33-2-C1-C	8×4	0.033	3.5	0.043	#10×3/4"	2	C	Cyclic-CUREE
8×4×350-43×33-2-C2-C	8×4	0.033	3.5	0.043	#10×3/4"	2	C	Cyclic-CUREE
8×2×350-43×33-2-C1-C	8×2	0.033	3.5	0.043	#10×3/4"	2	C	Cyclic-CUREE
8×2×350-43×33-2-C2-C	8×2	0.033	3.5	0.043	#10×3/4"	2	C	Cyclic-CUREE

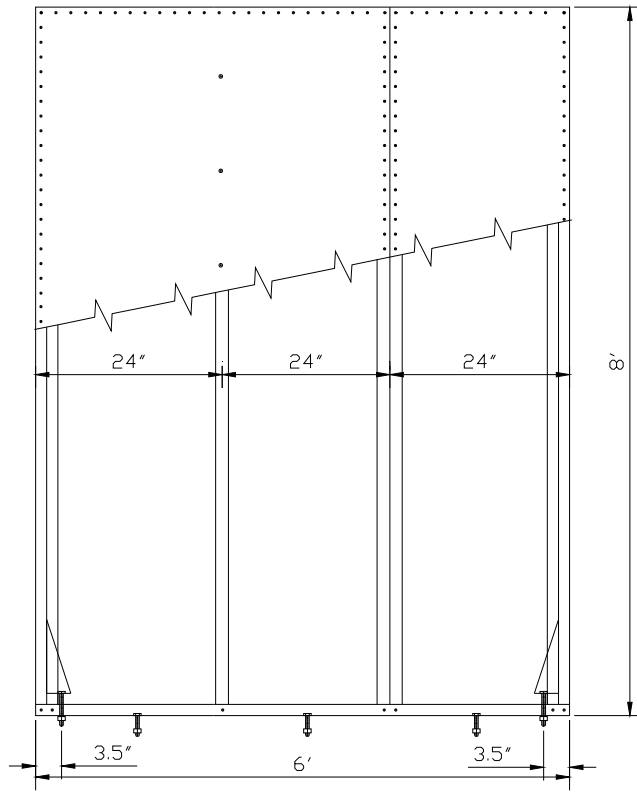
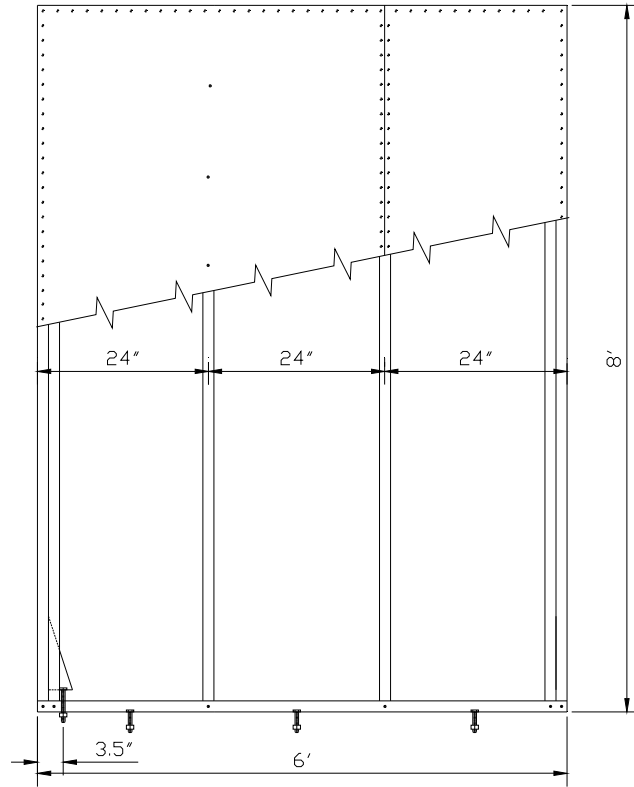
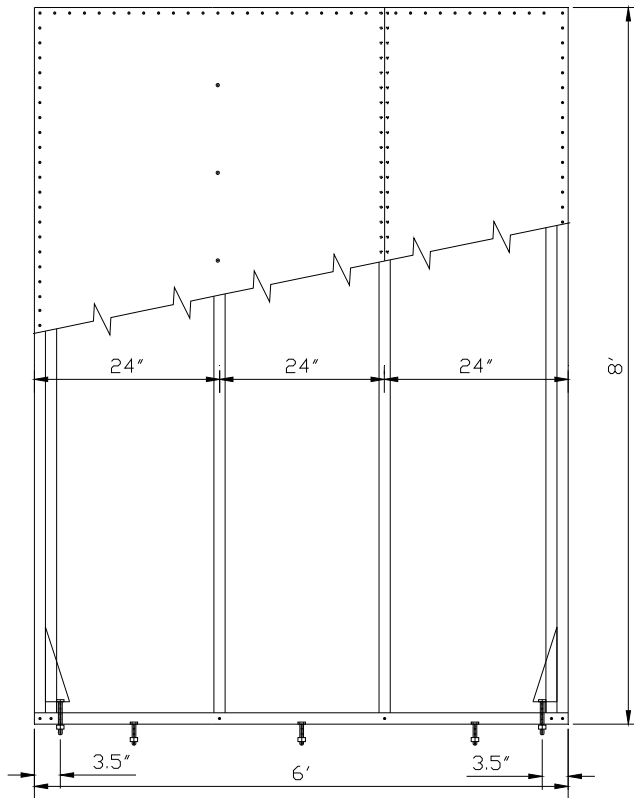

Figure 8 Dimensions of 8-ft. x 6-ft. wall assembly – Configuration A



(a) assembly for monotonic tests



(b) assembly for cyclic tests

Figure 9 Dimensions of 8-ft. x 6-ft. wall assembly – Configuration B

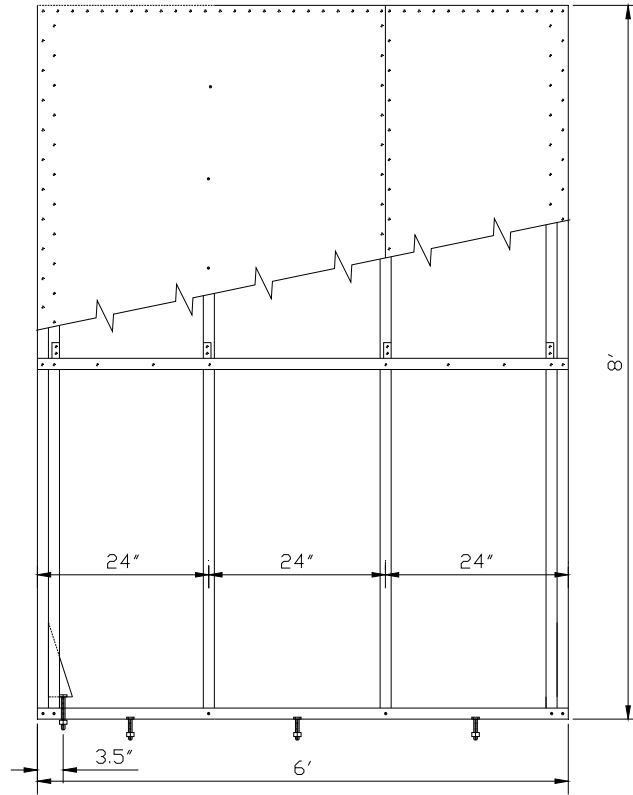

(a) assembly for monotonic tests

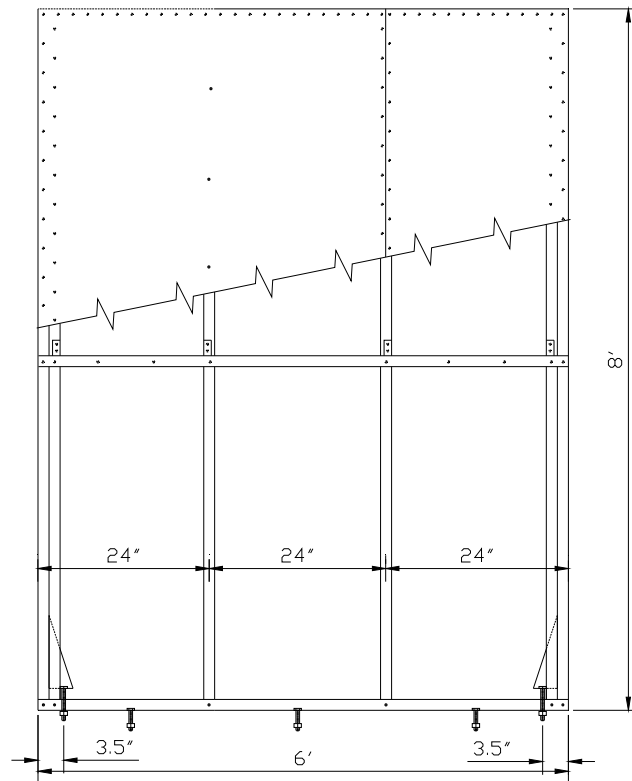

(b) assembly for cyclic tests

Figure 10 Dimensions of 8-ft. × 6-ft. wall assembly – Configuration C

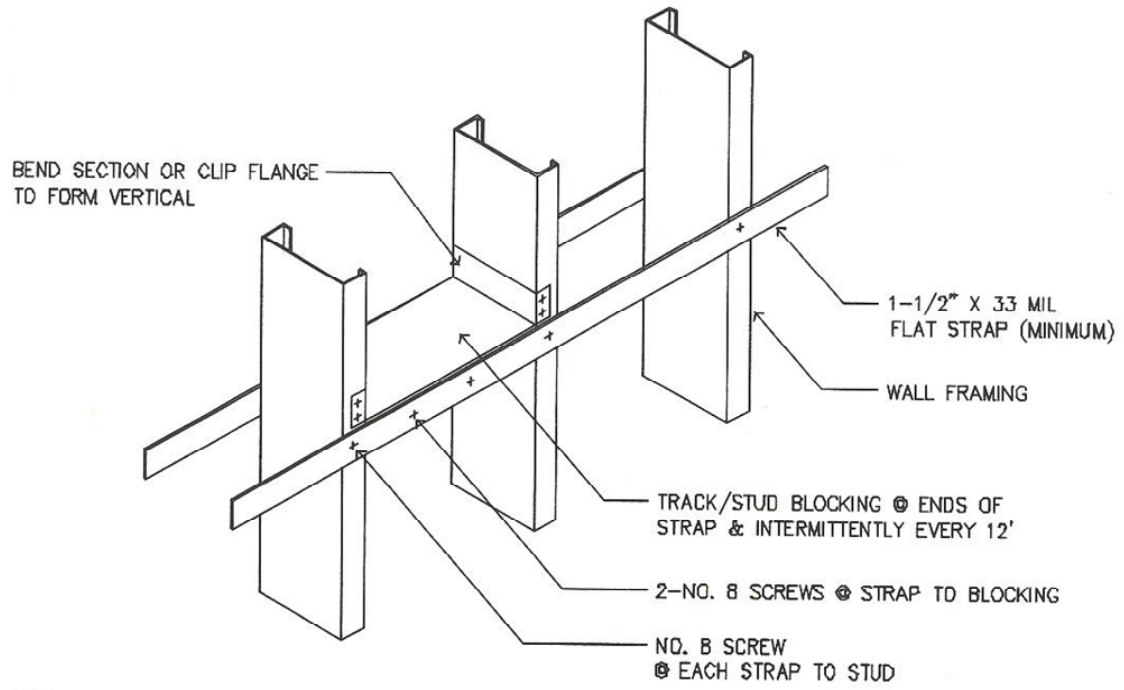
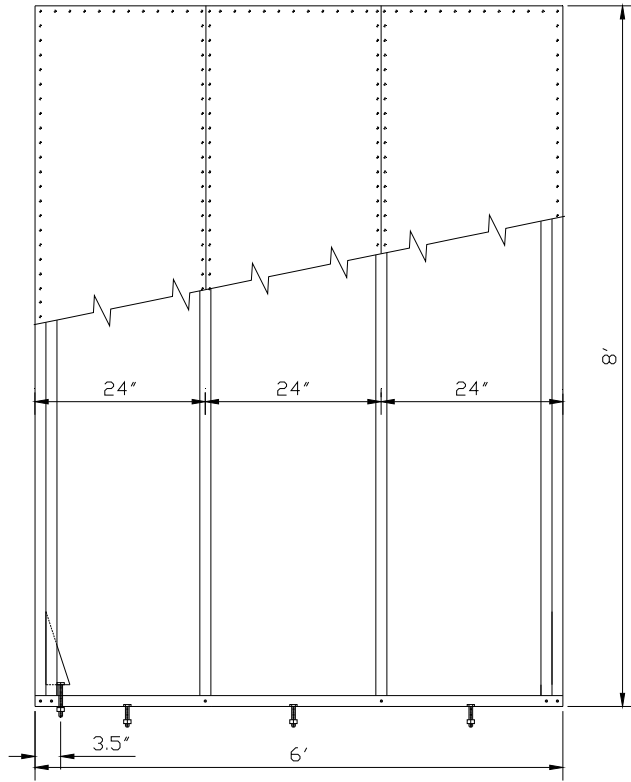
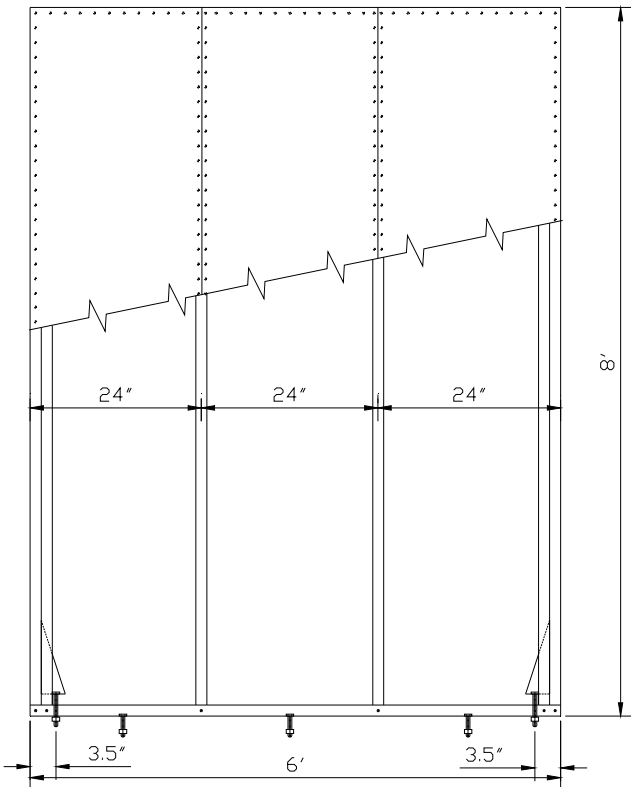

Figure 11 Strapping and blocking details for wall configuration C (Excerpt from AISI S230-07)



(a) assembly for monotonic tests



(b) assembly for cyclic tests

Figure 12 Dimensions of 8-ft. × 6-ft. wall assembly – Configuration D

The details of the components of the shear walls in Task 2 are given as follows:

Studs:

- 350S162-43 SSMA structural stud, 0.043-in. 3-1/2-in. × 1-5/8-in. made of Grade 33 steel, placed in 24-in. o. c.
- 350S162-54 SSMA structural stud, 0.054-in. 3-1/2-in. × 1-5/8-in. made of Grade 50 steel, placed in 24-in. o. c.
- 600S162-43 SSMA structural stud, 0.043-in. 6-in. × 1-5/8-in. made of Grade 33 steel, placed in 24-in. o. c.

Tracks:

- 350T150-43 SSMA structural track, 0.043-in. 3-1/2-in. × 1-1/2-in. made of Grade 33 steel.
- 350T150-54 SSMA structural track, 0.054-in. 3-1/2-in. × 1-1/2-in. made of Grade 50 steel.
- 600T125-43 SSMA structural track, 0.043-in. 6-in. × 1-1/4-in. made of Grade 33 steel.

Sheathing:

- 0.027-in. thick Grade 33 steel.
- 0.030-in. thick Grade 33 steel.
- 0.033-in. thick Grade 33 steel.
- Steel sheet was installed on one side of the wall assembly.

Framing and Sheathing Screws:

- No. 8-18×1/2-in. modified truss head self-drilling tapping screws. Spacing at panel edge is listed in Table 8.
- Fastener spacing in the field of the sheathing is 12-in. for all specimen configurations.

Hold-Downs:

- Simpson Strong-Tie[®] S/HD10 hold-downs with No. 10-16×1-in. HWH self-drilling tapping screws, and with 1/2-in. diameter ASTM A490 anchor bolts. Hold-downs were raised 1.5-in. above the edge of the track flange. One hold-down was installed each for monotonic test, and two were used for each cyclic test.

Shear Anchor Bolts:

- 5/8-in. diameter ASTM A490 anchor bolts with standard cut washers and nuts. Two bolts were used for each wall assembly.

The vertical gaps between the double boundary studs and the tracks were measured prior to the testing. The location of the gap measurements are illustrated in Figure 7. Table 9 lists the pretest gaps for the specimens in Task 2.

Table 9 Measured gaps between boundary studs and tracks of specimens for Task 2

Test label	Gap 1 (in.)	Gap 2 (in.)	Gap 3 (in.)	Gap 4 (in.)
8×6×350-43×30-2-C1-A	0.084	0.102	0.094	0.036
8×6×350-43×30-2-C1-B	0.048	0.144	0.092	0.055
8×6×350-43×33-2-M1-C	0.033	0.088	0.052	0.037
8×6×350-43×33-2-C1-C	0.097	0.048	0.070	0.085
8×6×350-43×33-2-C2-C	0.063	0.021	0.046	0.041
8×6×350-43×30-2-M1-C	0.050	0.061	0.077	0.083
8×6×350-43×30-2-C1-C	0.087	0.050	0.068	0.083
8×6×350-43×30-2-C2-C	0.065	0.075	0.063	0.076
8×6×600-43×33-2-M1-C	0.125	0.200	0.146	0.185
8×6×600-43×33-2-C1-C	0.195	0.173	0.144	0.175
8×6×600-43×33-2-C2-C	0.177	0.142	0.145	0.155
8×6×350-54×33-2-M1-B	-	-	-	-
8×6×350-54×33-2-C1-B	0.094	0.082	0.086	0.000
8×6×350-54×33-2-C2-B	0.138	0.136	0.071	0.138
8×6×350-43×27-2-M1-D	0.080	0.076	0.170	0.121
8×6×350-43×27-2-C1-D	0.074	0.078	0.108	0.068
8×6×350-54×33-2-M1-C	0.078	0.129	0.178	0.009
8×6×350-54×33-2-C1-C	0.036	0.056	0.077	0.092
8×6×350-54×33-2-C2-C	0.082	0.111	0.125	0.079
8×4×350-43×33-2-C1-C	0.030	0.044	0.077	0.032
8×4×350-43×33-2-C2-C	0.081	0.099	0.092	0.079
8×2×350-43×33-2-C1-C	0.023	0.055	0.085	0.102
8×2×350-43×33-2-C2-C	0.025	0.070	0.094	0.049

Material Properties

Coupon tests were conducted according to the ASTM A370 (2006) “Standard Test Methods and Definitions for Mechanical Testing of Steel Products” to obtain the actual properties of the test materials in this project. The coupon test results are summarized in Table 10. The coating on the steel was removed by hydrochloric acid prior to the coupon tests. The coupons tests were conducted on the INSTRON[®] 4482 universal testing machine. An INSTRON[®] 2630-106 extensometer was employed to measure the tensile strain. The tests were conducted in displacement control at a constant rate of 0.05 in./min. A total of four coupons were tested for each member, and the average results are provided in Table 10.

Table 10 Coupon test results

Member	Uncoated Thickness (in.)	Yield Stress F_y , (ksi)	Tensile Strength F_u (ksi)	F_u/F_y	Elongation for 2 in. Gage Length (%)
33 ksi 18 mil steel sheet	0.0189	51.0	55.0	1.08	21%
33 ksi 27mil steel sheet	0.0294	46.8	54.9	1.18	27%
33 ksi 30 mil steel sheet	0.0286	48.9	55.6	1.08	24%
33 ksi 33 mil steel sheet	0.0358	47.2	53.6	1.14	33%
33 ksi 33 mil stud	0.0341	49.8	58.1	1.17	35%
33 ksi 43 mil stud	0.0430	47.6	55.1	1.15	29%
50 ksi 54 mil stud	0.0535	55.4	73.8	1.33	20%
33 ksi 33 mil track	0.0339	67.5	87.5	1.30	16%
33 ksi 43 mil track	0.0420	43.1	55.6	1.29	25%
50 ksi 54 mil track	0.0534	62.3	82.3	1.32	20%

The test results indicate that the measured uncoated thickness of 30-mil sheet, 43 mil track, and 54 mil stud and track is less than the required minimum base metal (i.e., uncoated) thickness per the AISI S201 Product Data (2007) Table B2-1. All the coupons meet the minimum ductility requirement by North American Specification for Design of Cold-Formed Steel Structural Members 2007 Edition (NASPEC 2007), which requires the tensile strength to yield strength ratio greater than 1.08, and the elongation on a 2-in. gage length higher than 10%.

TEST RESULTS AND DISCUSSION

Task 1 – Verifying nominal strength of 27-mil and 18-mil sheet steel shear walls

The test results for Task 1 are summarized in Table 11. The displacements in Table 11 represent the lateral displacement of the wall top at the peak load. The ductility factor, D , is defined as the ratio of the ultimate displacement (Δ_u) and the yield displacement (Δ_{yield}). The Δ_u and Δ_{yield} are determined in accordance with ASTM E2126 (2007). The observed failure mechanism is listed in Table 12.

Table 11 Test results for Task 1

Test label	Peak +load P_+ (plf)	Peak -load P_- (plf)	Average peak load (plf)	Disp. at P_+ (in.)	Disp. at P_- (in.)	Average disp. (in.)	Ductility factor
8×2×350-33×27-2-C1	824	826	825	2.60	2.08	2.34	-
8×2×350-33×27-6-M1	529	-	529	1.95	-	1.95	3.09
8×2×350-33×27-6-M2	567	-	567	2.62	-	2.62	4.22
8×2×350-33×27-6-C1	602	728	665	2.87	2.32	2.59	-
8×2×350-33×27-6-C2	736	602	669	3.35	1.99	2.67	6.00
8×4×350-33×18-6-M1	427	-	427	2.10	-	2.10	4.29
8×4×350-33×18-6-M2	470	-	470	1.25	-	1.25	9.45
8×4×350-33×18-6-C1	489	484	487	1.15	1.40	1.27	10.52
8×4×350-33×18-6-C2	512	536	524	1.00	1.60	1.30	7.11
8×2×350-33×27-2-M1	856	-	856	2.15	-	2.15	2.60
8×2×350-33×27-2-M2	1002	-	1002	2.81	-	2.81	-
8×2×350-33×27-2-M3	984	-	984	2.34	-	2.34	1.64
8×2×350-33×27-2-C2	894	804	849	2.55	2.37	2.46	-
8×2×350-33×27-2-C3	960	864	912	1.91	1.68	1.79	2.89

Table 12 Failure modes for Task 1

Test label	Failure mode
8×2×350-33×27-2-C1	Steel sheet buckled, the chord studs distorted in the outer flanges
8×2×350-33×27-6-M1	Steel sheet buckled, screw pulled off the frame along the bottom portion of the chord studs
8×2×350-33×27-6-M2	Steel sheet buckled and screw pulled off the frame along the bottom portion of the chord studs
8×2×350-33×27-6-C1	Steel sheet buckled and screw pulled off the frame along the bottom portion of the chord studs
8×2×350-33×27-6-C2	Steel sheet buckled and screw pulled off the frame along the both bottom portion of the chord studs and top of the chord stud.
8×4×350-33×18-6-M1	Steel sheet buckled, the chord studs distorted on the flange at top, the interior stud distorted on flange at center.
8×4×350-33×18-6-M2	Steel sheet buckled and screw pulled off the frame at the left top corner
8×4×350-33×18-6-C1	Steel sheet buckled and screw pulled off the frame along the both bottom portion of the chord studs and at the center of the single stud
8×4×350-33×18-6-C2	Steel sheet buckled, screw pulled out from the top track and the mid-height of the single stud
8×2×350-33×27-2-M1	Steel sheet buckled, boundary studs buckled on the compression side of the wall

Table 12 Failure modes for Task 1 (Continued)

Test label	Failure mode
8×2×350-33×27-2-M2	Steel sheet buckled, boundary studs buckled on the compression side of the wall
8×2×350-33×27-2-M3	Steel sheet buckled, boundary studs buckled on the compression side of the wall
8×2×350-33×27-2-C2	Steel sheet buckled, distortion on flanges of boundary studs
8×2×350-33×27-2-C3	Steel sheet buckled, boundary studs buckled at bottom

The Task 1 work started with one cyclic test on one 8-ft.×2-ft. shear wall with 27-mil sheathing and 2-in. / 12-in. screw spacing. The test protocol was the same as that in Serrette (1996, 1997). Figure 13(a) shows the test hysteresis and Figure 13 (b) shows the specimen after the test. Permanent deformation existed on the sheathing after testing, no screw failure was observed. The peak load of the first test was 825 plf, which was close to the Phase 1 result (Yu 2007) on 27-mil 8-ft.×4-ft. shear wall (845 plf) and less than the result by Serrette (1997) on the same wall configuration (1171 plf).

The first test confirmed the Phase 1 conclusion: the published nominal shear strength for 33-mil framed shear walls sheathed with 27-mil steel sheets in AISI S213 (2007) is unconservative. In order to propose revised nominal shear strength for both wind and seismic loads, monotonic and cyclic tests on 27-mil sheet shear walls were performed in this research. No. 8 screws were used and the screw spacing at panel edges was 2-in. and 6-in. Figure 14 shows the typical failure mode for 27-mil sheet shear walls with 6-in. screw spacing. Screw pull-out from the bottom of boundary studs was observed in both monotonic and cyclic tests. For walls with 2-in. screw spacing, screw pull-out did not occur, the failure mode consisted of shear buckling of the sheathing and local buckling of the boundary studs at bottom. Figure 15 shows the failure on the boundary studs of a 27-mil sheet steel shear wall with 2-in. screw spacing on panel edges. On average, the cyclic tests yielded 21.7% higher peak load than the monotonic tests for the 27-mil sheet steel shear walls with 6-in. screw spacing. However for 27-mil sheet steel shear walls with 2-in. screw spacing, the monotonic and cyclic tests gave close peak loads.

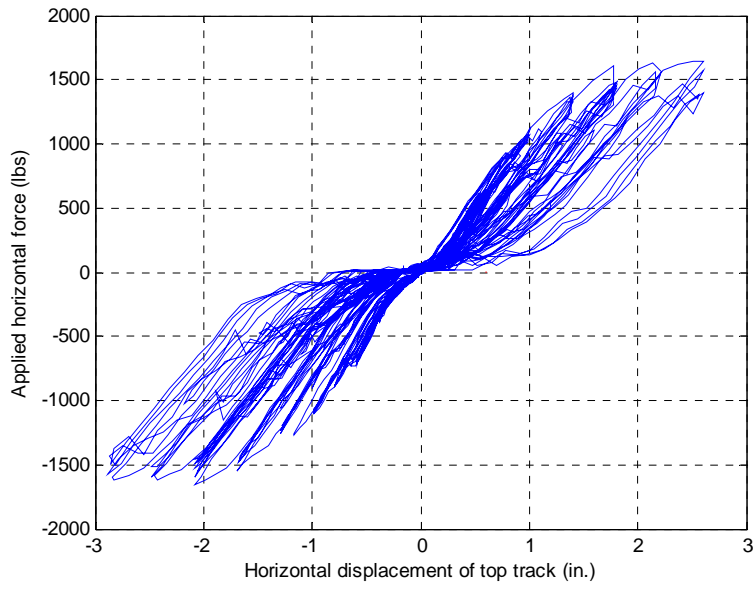

(a) Hysteresis



(b) Specimen after test

Figure 13 Test result of 8×2×350-33×27-2-C1



Figure 14 Screw pull-out failure on 27-mil sheet steel shear wall



Figure 15 Local buckling of boundary studs of 27-mil sheet steel shear wall

Based on the test results, the nominal shear strength for 27-mil sheet shear walls is established and listed in Tables 13 and 14. The values for 4-in. and 3-in. fastener spacing configurations in Tables 13 and 14 are determined by the linear interpolation of the values of 6-in. and 2-in. fastener spacing configurations. Serrette (1996, 1997) and Yu (2007) have proven that a linear relationship between the nominal shear strength and the fastener spacing at panel edges could be presumed for CFS shear walls sheathed by steel sheets.

The nominal shear strengths for 6-in. and 2-in. fastener spacing confirmations in both Table 13 and 14 were initially determined by taking the average peak load of two identical tests, and then adjusted per the North American Specification for the Design of Cold-Formed Steel Structural Members Chapter F (NASPEC 2007). NASPEC (2007) requires the nominal strength established from experimental results shall be adjusted according to the variation in the material thickness and yield or tensile strength, whichever is the critical factor, between the design values and the actual values in specimens. For the CFS shear wall assembly, the shear strength is most influenced by the steel sheathing, therefore the variation in the steel sheets is considered to adjust the test results.

The coupon tests indicate that the measured thickness for 27-mil sheet steel (0.0294-in) is greater than the design value (0.0283-in.), therefore the adjustment factor for variation in material thickness is $0.0283/0.0294 = 0.963$. The differences between the measured and the specified yield or tensile strength were also observed in the coupon tests for 27-mil steel sheet. Footnotes to the Tables 13 and 14 state the minimum material strengths (for steel sheet sheathing) required to use the tabulated nominal strength. The nominal strengths listed in Tables 13 and 14 are adjusted by the thickness factor only (0.963), and those values are recommended for the new version of the AISI Lateral Design Standards.

**Table 13 Recommended nominal shear strength for wind loads for shear walls^{1,2,4}
(Pounds Per Foot)**

Assembly description	Aspect ratio (h:w) ³	Fastener spacing at panel edges (inches)			
		6	4	3	2
0.027" steel sheet, one side	2:1	528	656	784	912

Note: (1) Screws in the field of panel shall be installed 12 in. o.c.
 (2) Steel sheet sheathing, wall studs, tracks, and blocking shall be of ASTM A1003 Grade 33 Type H Steel. Minimum yield strength, F_y , of 46 ksi and a minimum tensile strength, F_u , of 55 ksi are required for steel sheet sheathing.
 (3) Shear wall height to width aspect ratios (h/w) greater than 2:1, but not exceeding 4:1, shall be permitted provided the tabulated nominal strength values are multiplied by $2w/h$.
 (4) Wall studs, tracks, and blocking shall be of 33 mils or thicker, but the framing thickness shall be limited and/or the screw diameter increased to ensure that the screw itself not fail in shear.

**Table 14 Recommended nominal shear strength for seismic loads for shear walls^{1,2,4}
(Pounds Per Foot)**

Assembly description	Aspect ratio (h:w) ³	Fastener spacing at panel edges (inches)			
		6	4	3	2
0.027" steel sheet, one side	2:1	642	738	783	830
Note: (1) Screws in the field of panel shall be installed 12 in. o.c. (2) Steel sheet sheathing, wall studs, tracks, and blocking shall be of ASTM A1003 Grade 33 Type H Steel. Minimum yield strength, F_y , of 46 ksi and a minimum tensile strength, F_u , of 55 ksi are required for steel sheet sheathing. (3) Shear wall height to width aspect ratios (h/w) greater than 2:1, but not exceeding 4:1, shall be permitted provided the tabulated nominal strength values are multiplied by 2w/h. (4) Wall studs, tracks, and blocking shall be of 33 mils or thicker, but the framing thickness shall be limited and/or the screw diameter increased to ensure that the screw itself not fail in shear.					

Tables 15 and 16 list the nominal strength adjusted according to the variation in both material thickness and yield or tensile strength, whichever is the critical factor. The adjustment factor is calculated as $(F_{y-spec'd}/F_{y-tested})(t_{design}/t_{tested}) = 0.679$. It indicates that the reduction is too conservative for CFS shear wall assembly, future testing is needed to develop an appropriate approach to adjust the experiment results of CFS shear walls.

**Table 15 Adjusted nominal shear strength for wind loads for shear walls^{1,2,4}
(Pounds Per Foot)**

Assembly description	Aspect ratio (h:w) ³	Fastener spacing at panel edges (inches)			
		6	4	3	2
0.027" steel sheet, one side	2:1	372	462	553	643
Note: (1) Screws in the field of panel shall be installed 12 in. o.c. (2) Sheet steel sheathing, wall studs, tracks, and blocking shall be of ASTM A1003 Grade 33 Type H steel with specified yield strength, F_y , of 33 ksi and a specified tensile strength, F_u , of 45 ksi. (3) Shear wall height to width aspect ratios (h/w) greater than 2:1, but not exceeding 4:1, shall be permitted provided the tabulated nominal strength values are multiplied by 2w/h. (4) Wall studs, tracks, and blocking shall be of 33 mils or thicker, but the framing thickness shall be limited and/or the screw diameter increased to ensure that the screw itself not fail in shear.					

**Table 16 Recommended nominal shear strength for seismic loads for shear walls^{1,2,4}
(Pounds Per Foot)**

Assembly description	Aspect ratio (h:w) ³	Fastener spacing at panel edges (inches)			
		6	4	3	2
0.027" steel sheet, one side	2:1	453	520	552	585
Note: (1) Screws in the field of panel shall be installed 12 in. o.c. (2) Sheet steel sheathing, wall studs, tracks, and blocking shall be of ASTM A1003 Grade 33 Type H steel with specified yield strength, F_y , of 33 ksi and a specified tensile strength, F_u , of 45 ksi. (3) Shear wall height to width aspect ratios (h/w) greater than 2:1, but not exceeding 4:1, shall be permitted provided the tabulated nominal strength values are multiplied by 2w/h. (4) Wall studs, tracks, and blocking shall be of 33 mils or thicker, but the framing thickness shall be limited and/or the screw diameter increased to ensure that the screw itself not fail in shear.					

Task 1 work was also aimed at verifying the published nominal shear strength for 18-mil sheet steel shear walls in AISI S213 (2007). Two monotonic and two cyclic tests were performed on 33-mil framed shear walls with 18-mil steel sheets. Table 17 provides a comparison between the Phase 2 tests and the AISI S213 values for the nominal shear strength. The Phase 2 results are adjusted only by the variation in the material thickness. Table 17 indicates that the tested nominal strength for wind loads of the 18-mil sheet steel shear walls is close to and slightly lower than the those published in AISI S213 (2007). The difference is 9.2% which is within the test result tolerance. However, the tested nominal strength for seismic loads of the 18-mil sheet wall is 29.0% higher than the published values. It could be concluded that the published nominal strength in AISI S213 (2007) for the 18-mil steel sheet shear wall is reasonable for the wind design. Discrepancy in the nominal strength of 18-mil sheet steel for seismic loads is found, and further investigation is needed. It is recommended that the future research tests shear wall assemblies with material strengths and thicknesses close to the minimum specified values and compares to these results of this test program. The details of the test results of Task 1 are provided in Appendix A.

Table 17 Comparison of nominal shear strength for 33-mil framed walls with No. 8 screws 6-in. o.c. at panel edges^{1,2,3}

Assembly description	Aspect ratio (h:w)	For wind loads (plf)	For seismic loads (plf)
AISI S213 - 0.018" steel sheet, one side	2:1	485	390
Phase 2 - 0.018" steel sheet, one side ⁴	2:1	447	503
Note: (1) Screws in the field of panel shall be installed 12 in. o.c. (2) Sheet steel sheathing, wall studs, tracks, and blocking shall be of ASTM A1003 Grade 33 Type H steel with minimum yield strength, F_y , of 46 ksi and a minimum tensile strength, F_u , of 55 ksi. (3) Shear wall height to width aspect ratios (h/w) greater than 2:1, but not exceeding 4:1, shall be permitted provided the tabulated nominal strength values are multiplied by 2w/h. (4) Wall studs, tracks, and blocking shall be of 33 mils or thicker, but the framing thickness shall be limited and/or the screw diameter increased to ensure that the screw itself not fail in shear.			

Task 2 – Special detailing for 8-ft. × 6-ft. shear walls sheathed with steel sheets

The test results for Task 2 are summarized in Table 18. Table 19 lists the observed failure mechanism. The details of the test results are provided in Appendix B.

Table 18 Test results for Task 2

Test label	Peak +load P ₊ (plf)	Peak -load P ₋ (plf)	Average peak load (plf)	Disp. at P ₊ (in.)	Disp. at P ₋ (in.)	Average disp. (in.)	Ductility factor
8×6×350-43×30-2-C1-A	1051	1040	1045	1.03	1.68	1.35	6.24
8×6×350-43×30-2-C1-B	1263	1223	1243	1.36	1.68	1.61	5.91
8×6×350-43×33-2-M1-C	1215	-	1215	1.74	-	1.74	6.38
8×6×350-43×33-2-C1-C	1575	1482	1529	1.07	1.13	1.10	3.39
8×6×350-43×33-2-C2-C	1528	1442	1485	1.21	1.33	1.27	4.16
8×6×350-43×30-2-M1-C	1255	-	1255	1.41	-	1.41	4.31
8×6×350-43×30-2-C1-C	1293	1389	1341	1.33	1.71	1.52	-
8×6×350-43×30-2-C2-C	1340	1405	1372	1.75	1.11	1.42	-
8×6×600-43×33-2-M1-C	1354	-	1354	1.72	-	1.72	2.95
8×6×600-43×33-2-C1-C	1514	1481	1497	1.58	1.60	1.59	2.56
8×6×600-43×33-2-C2-C	1498	1456	1477	1.01	1.00	1.01	3.90
8×6×350-54×33-2-M1-B	1699	-	1699	1.87	-	1.87	3.40
8×6×350-54×33-2-C1-B	1731	1958	1845	1.32	1.96	1.64	-
8×6×350-54×33-2-C2-B	1801	1994	1898	1.31	1.37	1.34	3.14
8×6×350-43×27-2-M1-D	1380	-	1380	1.36	-	1.36	4.88
8×6×350-43×27-2-C1-D	1492	1440	1466	1.41	1.43	1.42	4.20
8×6×350-54×33-2-M1-C	1989	-	1989	2.49	-	2.49	3.40
8×6×350-54×33-2-C1-C	2001	1986	1994	1.68	1.63	1.65	4.11
8×6×350-54×33-2-C2-C	2143	2205	2174	1.46	1.66	1.56	3.66
8×4×350-43×33-2-C1-C	1605	1546	1576	1.17	1.41	1.29	2.89
8×4×350-43×33-2-C2-C	1616	1531	1574	1.43	1.85	1.64	3.79
8×2×350-43×33-2-C1-C	1547	1667	1607	2.08	2.31	2.20	3.21
8×2×350-43×33-2-C2-C	1655	1570	1613	2.21	2.43	2.32	3.28

Table 19 Failure modes for Task 2

Test label	Failure mode
8×6×350-43×30-2-C1-A	Steel sheet buckled and pulled off along the bottom portion of the chord studs and track, the single stud buckled and the interior double studs separated
8×6×350-43×30-2-C1-B	Steel sheet buckled, screw pulled out at corners of the panel, two interior studs buckled
8×6×350-43×33-2-M1-C	Steel sheet buckled, screws pulled out at center of interior stud, flange of chord studs distorted
8×6×350-43×33-2-C1-C	Steel sheet buckled, screws pulled out at the bottom of joint stud and mid-height of field stud
8×6×350-43×33-2-C2-C	Steel sheet buckled, screws pulled out at the bottom of joint stud and mid-height of field stud
8×6×350-43×30-2-M1-C	Steel sheet buckled, screw pulled out at mid height of studs
8×6×350-43×30-2-C1-C	Steel sheet buckled, screws pulled out at the mid height of one interior stud
8×6×350-43×30-2-C2-C	Steel sheet buckled, screws pulled out at the mid height of one interior stud
8×6×600-43×33-2-M1-C	Steel sheet buckled, screw pulled out at center of interior studs, bottom track damaged by pulling of the sheets
8×6×600-43×33-2-C1-C	Steel sheet buckled, screws pulled out, interior stud buckled
8×6×600-43×33-2-C2-C	Steel sheet buckled, screws pulled out at interior stud center and at panel corners, one interior stud distorted
8×6×350-54×33-2-M1-B	Steel sheet buckled, screw pulled out at center of filed studs, flange of chord studs distorted at bottom corner
8×6×350-54×33-2-C1-B	Steel sheet buckled, screws pulled out at the mid-height of field stud. Flange of chord studs distorted at bottom
8×6×350-54×33-2-C2-B	Steel sheet buckled, screws pulled out at the mid-height of field stud, one interior stud is buckled
8×6×350-43×27-2-M1-D	Steel sheet buckled, interior stud distorted, chord studs distorted on flanges at panel corners
8×6×350-43×27-2-C1-D	Steel sheet buckled, one interior stud buckled
8×6×350-54×33-2-M1-C	Steel sheet buckled, screws pulled out at the mid-height of the interior stud, the interior stud and bottom of the tension stud buckled
8×6×350-54×33-2-C1-C	Steel sheet buckled, screws pulled out at the bottom of joint stud and mid-height of field stud
8×6×350-54×33-2-C2-C	Steel sheet buckled, screws pulled out at the mid height of the field stud
8×4×350-43×33-2-C1-C	Steel sheet buckled, screws pulled out at the mid-height of the field stud
8×4×350-43×33-2-C2-C	Steel sheet buckled, screws pulled out at the mid-height of the field stud
8×2×350-43×33-2-C1-C	Steel sheet buckled, both chord studs buckled at the bottom
8×2×350-43×33-2-C2-C	Steel sheet buckled, both chord studs buckled at bottom

Task 2 work started with two pilot cyclic tests on 30-mil sheet shear walls with two sheet joint configurations, A and B. Configuration A used double studs at the sheet joint, while Configuration B used a single stud at the sheet joint. Figures 16 and 17 respectively show the test hysteresis and failure mode for the shear wall with configuration A. The test 8×6×350-43×30-2-C1-A failed by flexural buckling of the single interior stud and screw pull-out at the joint, which in turn resulted in the separation of the double studs. Sheathing screw pull-out was also observed at the panel corners and on the single interior stud. Figures 18 and 19 respectively show the test hysteresis and failure mode of the shear wall with configuration B. The test 8×6×350-43×30-2-C1-B failed by flexural buckling of the interior studs and sheathing screws pulled out at the corner and in the field of the panel. The shear wall with configuration B yielded a 19% higher

peak load than that of the configuration A wall. Both shear walls demonstrated similar ductility. The boundary studs in both tests were able to provide sufficient overturning resistance. However the failure of the interior stud occurred in both tests, which could cause collapse of the structures in earthquakes or strong winds.

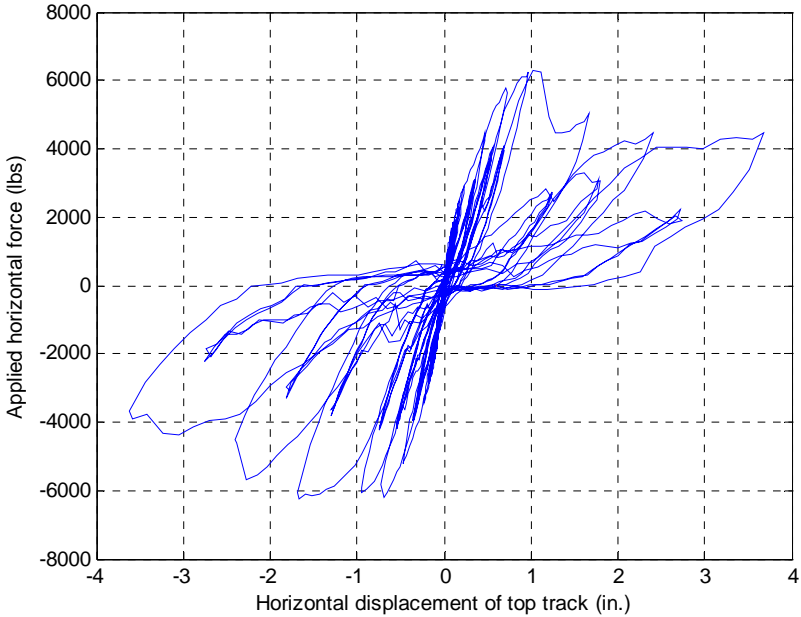

Figure 16 Test hysteresis for 8x6x350-43x30-2-C1-A



Figure 17 Failure mode of test 8x6x350-43x30-2-C1-A

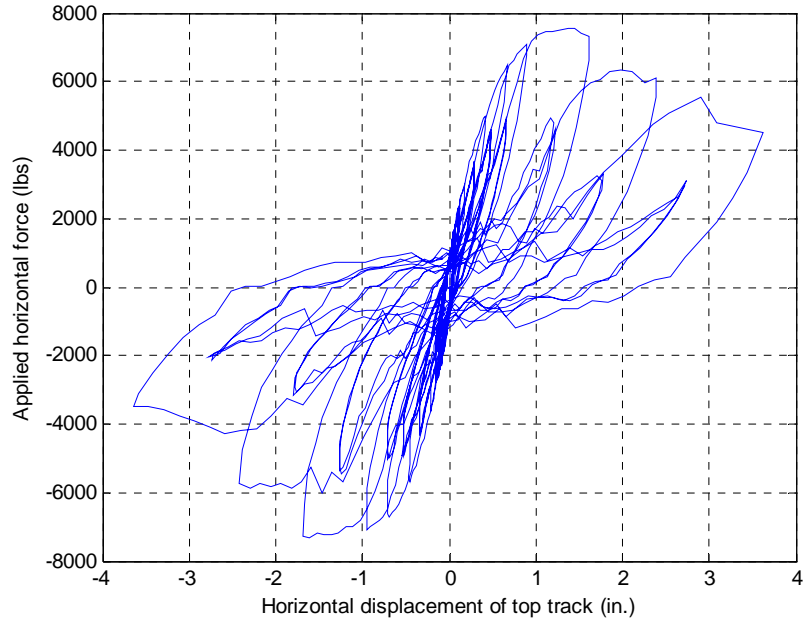

Figure 18 Test hysteresis for 8x6x350-43x30-2-C1-B



Figure 19 Failure mode of test 8x6x350-43x30-2-C1-B

In order to prevent failure in the studs, a wall configuration C was developed by adding special detailing to the configuration B. As specified in the previous section, the special details included No. 10×3/4” screws to replace No. 8×1/2” screws, adding blocking and strapping, and using a staggered screw pattern at the end and joint studs. Figures 20 and 21 respectively show post-test photos of the 30-mil and 33-mil sheet steel shear walls with configuration C. The flexural buckling of the interior studs was successfully restricted by the blocking and strapping. Damage on the flange of the interior stud in the panel field was observed due to the pull-out of the sheathing screws. The special details also improved the shear strength of the shear wall. For the 30-mil sheet steel shear wall, a 9% increase in max capacity was found on configuration C walls compared with the configuration B wall.

The special detailing (wall configuration C) was also applied to 43-mil 6-in. framed shear walls with 33-mil sheathing. Figure 22 shows failure mode of the test 8×6×600-43×30-2-C1-C. Moderate distortion of the interior stud at the field of the 4-ft. sheet occurred, and screw pull-out was observed at the deformed interior stud and at the bottom of the joint stud. The 6-in. framed shear walls did not give higher shear strength than the 3.5-in. framed shear walls using the same sheathing and fastener configurations. The two cyclic tests on 6-in. framed wall with 33-mil sheathing yielded 1487 plf in average. The two cyclic tests on 3.5-in. framed wall with 33-mil sheathing yielded 1507 plf in average. It suggests that the nominal strength for 3.5-in. framed shear walls can be used for 6-in. framed shear walls with the same details in framing, sheathing and the fastener configuration.



**Figure 20 Failure mode of test
8×6×350-43×30-2-C1-C**



**Figure 21 Failure mode of test
8×6×350-43×33-2-C1-C**



Figure 22 Failure mode of test 8x6x600-43x30-2-C1-C

Monotonic and cyclic tests were also performed on 54-mil framed shear walls sheathed with 33-mil sheets with and without the special detailing. Figure 23 shows the failure mode of the cyclic test on a 54-mil framed wall without the special detailing. The wall failed by the screw pull-out from the center of the interior stud and from the bottom of the boundary studs. The screw pull-out also caused distortion of the stud flange. However the studs were able to maintain their original shape after the tests. Figure 24 shows the failure mode of the cyclic tests on a 54-mil framed wall with the special detailing. Similar to the wall without special detailing, the wall with special detailing demonstrated screw pull-out at the interior and boundary studs which resulted in distortion of the stud flanges at those locations. No flexural buckling failure was observed on the studs. The special detailing increased the shear strength of the 54-mil framed shear wall by an average of 11.4% for the cyclic loading. The ductility of the shear wall was also improved as the cyclic tests showed an average of 21.7% increase in the ductility factor for the 54-mil framed shear walls with the special detailing compared with the walls without special detailing.



Figure 23 Failure mode of test 8x6x350-54x33-2-C1-B



Figure 24 Failure mode of test 8x6x350-54x33-2-C2-C

The special detailing was also experimentally studied on 8-ft. \times 4-ft. and 8-ft. \times 2-ft. shear walls in order to investigate the improved performance of walls with a broader range of aspect ratios. The tested 8-ft. \times 4-ft. and 8-ft. \times 2-ft. shear walls were sheathed with 33-mil sheets and framed by 43-mil studs and tracks. The 8-ft. \times 4-ft. walls failed by screw pull-out at the center of the interior stud and at the corners of the panel. No flexural buckling occurred on the studs. Figure 25 shows the failure mode of a cyclic test of 8-ft. \times 4-ft. wall with the special detailing. Figure 26 shows a

direct comparison of the hysteresis curves of two 8-ft.×4-ft. shear walls with 33-mil sheathing and 2-in. screw spacing at panel edges. One test was performed in Phase 1 (Yu 2007) without special detailing. The second test was conducted in this Phase 2 work with special detailing. It is clear that the special detailing increases both initial elastic stiffness and the shear strength of the shear wall. The average increase in the nominal shear strength is 16.7%.

Similar improvements by the special detailing were also discovered on the cyclic tests of 8-ft.×2-ft. shear walls. Figure 27 shows the comparison of the hysteresis curves. On average, the shear strength of the 8-ft.×2-ft. shear walls with 33-mil sheathing and 2-in. fastener spacing at panel edges was improved by 18.3%.

It should be noted that the 43-mil studs and tracks in both Phase 1 and Phase 2 were provided by the same manufacturer in one shipment, therefore having the same mechanical properties and thickness. The 33-mil steel sheets in the two phases were provided by different manufactures. However the measured uncoated thickness and the tested mechanical properties for the 33-mil steel sheets in the Phases 1 and 2 are close, therefore the difference in sheathing should not significantly affect shear strength of the wall assemblies.



Figure 25 Failure mode of test 8×4×350-43×33-2-C1-C

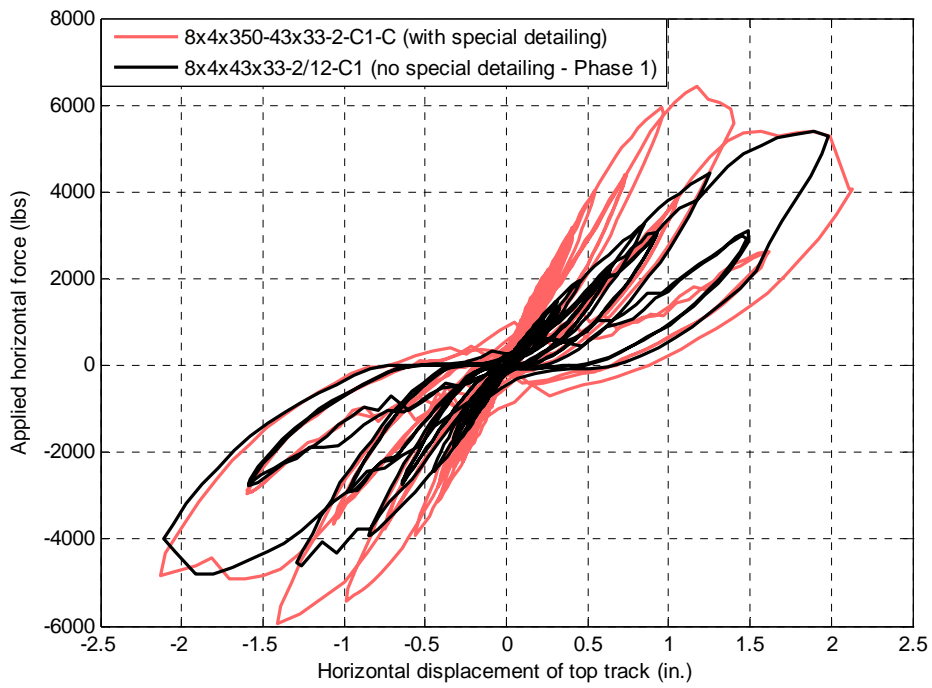

Figure 26 Test hysteresis curves for 8-ft. x 4-ft. walls with 33-mil sheathing

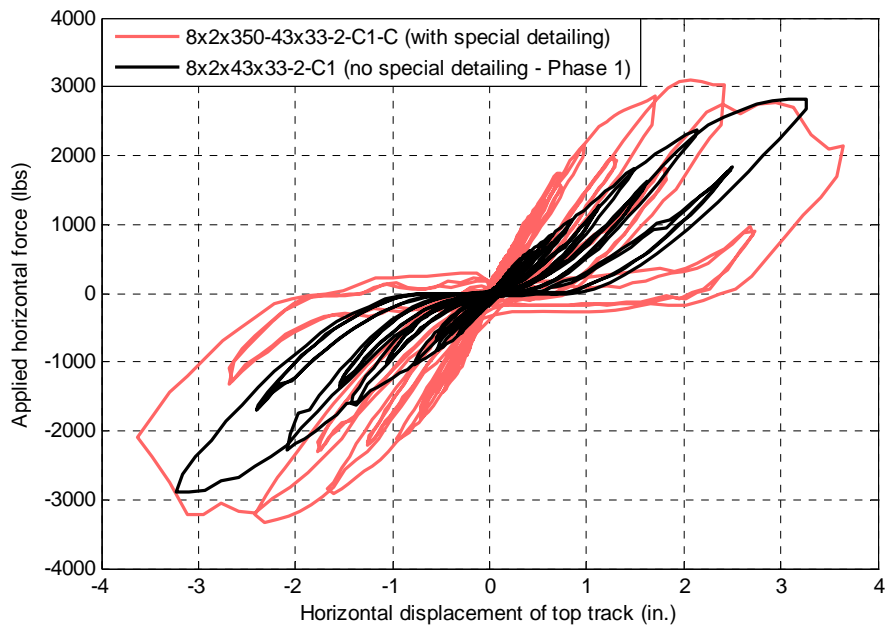

Figure 27 Test hysteresis curves for 8-ft. x 2-ft. walls with 33-mil sheathing

Task 2 was focused on 6-ft. wide shear walls sheathed with one 4-ft. and one 2-ft. wide steel sheets. The use of three 2-ft. wide steel sheets-wall configuration D- is also a practical method to assemble a 6-ft. wide shear wall. Task 2 tests included one monotonic test and one cyclic test on 8-ft. × 6-ft. 33-mil framed shear wall sheathed with three 27-mil 8-ft. × 2-ft. sheets. The special detailing was not installed for these two tests. Figure 28 and 29 respectively show the failure mode of the monotonic and cyclic test with wall configuration D. Both tests failed by the distortion of the stud flanges at the panel corners as well as at the lower portion of one interior stud. Screw pull-out failure on the test was not observed. Compared with 8-ft. × 4-ft. shear walls with 27-mil sheathing in Phase 1, the 8-ft. × 6-ft. walls yielded higher unit shear strength due to the stronger framing members being used (43 mil vs. 33 mil). The special detailing is recommended for the 6-ft. wide shear walls using multiple steel sheets to avoid potential damage on the studs.



Figure 28 Failure mode of 8x6x350-43x27-2-M1-D



Figure 29 Failure mode of 8x6x350-43x27-2-C1-D

Based on the cyclic test results, the nominal shear strength for seismic loads for shear walls investigated Task 2 can be obtained by taking the average of two identical tests for each configuration. The nominal shear strength is provided in Table 20. Similarly to Task 1 work, the nominal strengths listed in Table 20 are adjusted only by the variation in the material thickness between the design values and the actual values in steel sheets. Footnotes to the table address the variation in the material yield strength.

Table 20 Recommended nominal shear strength for seismic loads for shear walls¹
(Pounds Per Foot)

Assembly description ²	Aspect ratio (h:w) ⁴	Fastener spacing at panel edges	Nominal thickness of framing	Required sheathing screw Size	Required blocking and strapping ⁵
		2 inches			
0.033" steel sheet, one side	2:1	1507	43 mil ²	10	Yes
0.030" steel sheet, one side	2:1	1357	43 mil ²	10	Yes
0.033" steel sheet, one side	2:1	1872	54 mil ³	8	No
0.033" steel sheet, one side	2:1	2084	54 mil ³	10	Yes
0.033" steel sheet, one side	2:1	1575	43 mil ²	10	Yes

Note:

- (1) Screws in the field of panel shall be installed 12 in. o.c.
- (2) Sheet steel sheathing, wall studs, tracks, and blocking shall be of ASTM A1003 Grade 33 Type H steel with minimum yield strength, F_y , of 46 ksi and a minimum tensile strength, F_u , of 55 ksi.
- (3) Wall studs, tracks, and blocking shall be of ASTM A1003 Grade 50 Type H steel with minimum yield strength, F_y , of 55 ksi and a minimum tensile strength, F_u , of 74 ksi.
- (4) Shear wall height to width aspect ratios (h/w) greater than 2:1, but not exceeding 4:1, shall be permitted provided the tabulated nominal strength values are multiplied by 2w/h.
- (5) Blocking and strapping shall be the same thickness as the framing. Strapping shall be of 33 mil minimum, installed on both sides of the wall.

Reduction factor for slender shear walls

The AISI Lateral Design Standard (2007) permits CFS shear walls with steel sheathing to exceed the 2:1 aspect ratio limit, but requires that the nominal shear strength be reduced by a factor of 2w/h for those shear walls with a height to width aspect ratio (h/w) greater than 2:1 but not exceeding 4:1.

It also requires that the allowable strength (ASD) be determined by dividing the nominal shear strength by a safety factor of 2.5 for assemblies resisting seismic loads and 2.0 for assemblies resisting wind loads. The 2006 International Building Code limits story drift for seismic force-resisting systems for structures 4 stories or less with interior walls, partitions, ceilings and exterior wall systems that have been designed to accommodate the story drifts to 0.025h. This story drift limit is 0.60" for LRFD ($0.025h/C_d$) and 0.43" (LRFD story drift / 1.4) for ASD for an 8-ft. wall height. There is no in-plane story drift limit for wind loads yet defined by the codes, but ASCE 7-05 Commentary Section CC.1.2 states "Drifts of concern in serviceability checking arise primarily from the effects of wind. Drift limits in common usage for building design are on the order or 1/600 to 1/400 of the story height. An absolute limit on interstory drift may also need to be imposed in light of evidence that damage to non-structural partitions, cladding and glazing may occur if the interstory drift exceeds about 3/8" unless special detailing practices are made to tolerate movement."

Table 21 summarizes the actual drift reduction factors for monotonic tests in both tasks. Figure 30 illustrates the comparison of the code reduction factor and the actual reduction factors for the

monotonic tests. The reduction factors are determined by dividing the $h/180$ drift limited shear wall load value by the allowable shear strength (ASD) for wind loads. A safety factor of 2.0 was used to calculate the ASD allowable shear strength.

Table 22 summarizes the actual drift reduction factors for cyclic tests in both Task 1 and 2. Figure 31 shows the comparison of the code reduction factors and the actual values from the cyclic tests. The reduction factors for seismic loads are determined by dividing the 0.43-in. drift limited shear wall load value by the allowable shear strength (ASD) for seismic loads. A safety factor of 2.5 was used to calculate the ASD allowable shear strength.

Table 21 Actual drift reduction factor for monotonic tests

Test label	Aspect ratio	Actual reduction factor
8×2×350-33×27-6-M1	4:1	0.836
8×2×350-33×27-6-M2	4:1	0.964
8×4×350-33×18-6-M1	2:1	1.126
8×4×350-33×18-6-M2	2:1	1.556
8×2×350-33×27-2-M1	4:1	0.965
8×2×350-33×27-2-M2	4:1	0.769
8×2×350-33×27-2-M3	4:1	0.976
8×6×350-43×33-2-M1-C	4:3	1.652
8×6×350-43×30-2-M1-C	4:3	1.612
8×6×600-43×33-2-M1-C	4:3	1.599
8×6×350-54×33-2-M1-B	4:3	1.250
8×6×350-43×27-2-M1-D	4:3	1.465
8×6×350-54×33-2-M1-C	4:3	1.045

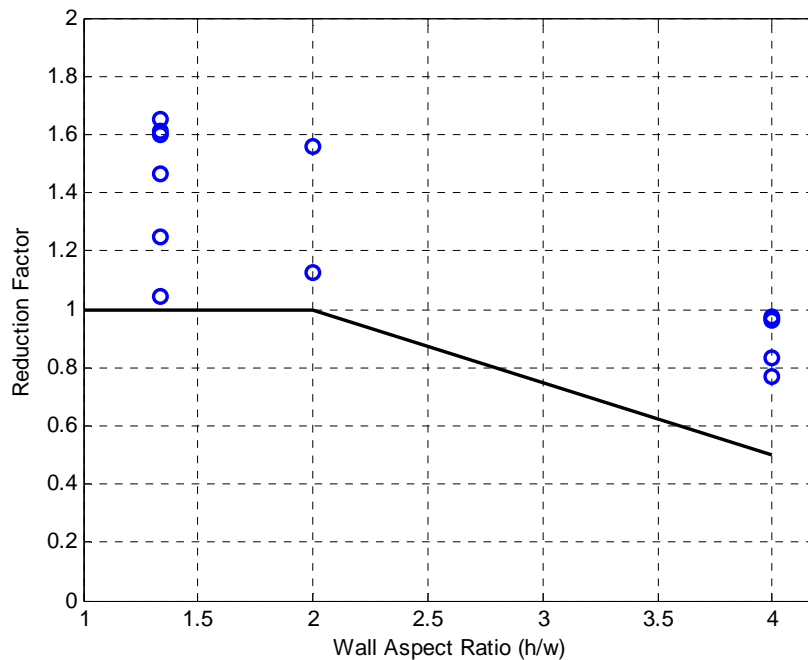

Figure 30 Reduction factors for monotonic tests

Table 21 Actual drift reduction factor for monotonic tests

Test label	Aspect ratio	Actual reduction factor
8×2×350-33×27-2-C1	4:1	0.760
8×2×350-33×27-6-C1	4:1	0.927
8×2×350-33×27-6-C2	4:1	1.108
8×4×350-33×18-6-C1	2:1	1.866
8×4×350-33×18-6-C2	2:1	1.780
8×2×350-33×27-2-C2	4:1	0.874
8×2×350-33×27-2-C3	4:1	1.103
8×6×350-43×30-2-C1-A	4:3	1.633
8×6×350-43×30-2-C1-B	4:3	1.766
8×6×350-43×33-2-C1-C	4:3	1.560
8×6×350-43×33-2-C2-C	4:3	1.588
8×6×350-43×30-2-C1-C	4:3	1.739
8×6×350-43×30-2-C2-C	4:3	1.656
8×6×600-43×33-2-C1-C	4:3	1.176
8×6×600-43×33-2-C2-C	4:3	1.764
8×6×350-54×33-2-C1-B	4:3	1.399
8×6×350-54×33-2-C2-B	4:3	1.406
8×6×350-43×27-2-C1-D	4:3	1.624
8×6×350-54×33-2-C1-C	4:3	1.376
8×6×350-54×33-2-C2-C	4:3	1.278
8×4×350-43×33-2-C1-C	2:1	1.318
8×4×350-43×33-2-C2-C	2:1	1.600
8×2×350-43×33-2-C1-C	4:1	0.967
8×2×350-43×33-2-C2-C	4:1	1.030

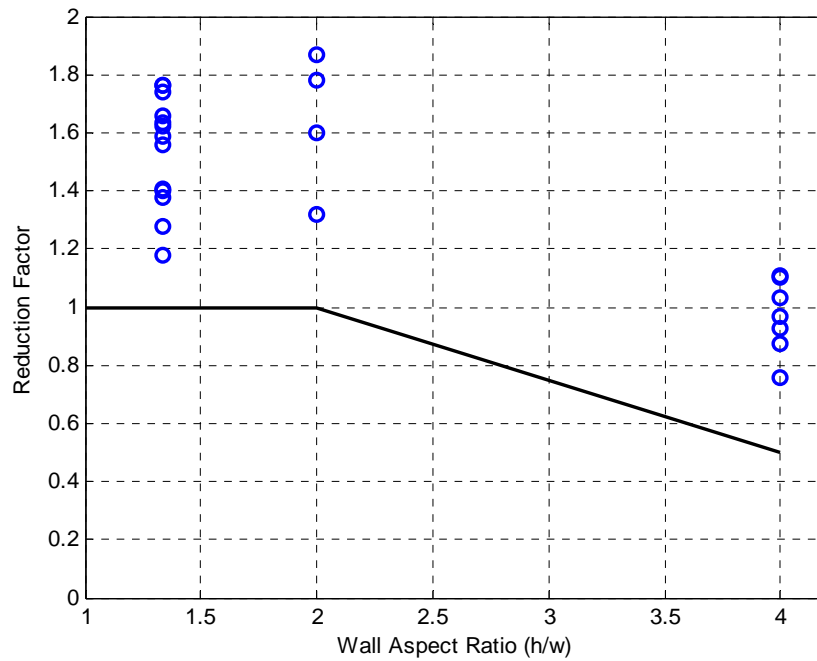

Figure 31 Reduction factors for cyclic tests

Figures 30 and 31 indicate that the shear strength of slender CFS shear walls (aspect ratio greater than 2:1) shall be reduced due to the higher flexibility. The code reduction factor $2w/h$ (AISI S213) is conservative for the tested CFS shear walls with an aspect ratio of 4:1, further research is needed to develop more accurate equation for the reduction factor.

CONCLUSIONS AND FUTURE RESEARCH

CFS sheet shear walls with various configurations in framing and sheathing were experimentally studied for two main goals: (1) to verify the published nominal shear strength for 18-mil and 27-mil steel sheets, and (2) to investigate the behavior and necessary detailing for 6-ft. wide CFS shear walls. The conclusions from this project can be drawn as follows.

In Task 1, it was found that the published nominal shear strength for a 33-mil framed shear wall with 27-mil steel sheets on one side is unconservative. Based on this test program, the revised nominal shear strength for 27-mil steel sheet are established and listed in Tables 13 and 14. Due to the lack of 18-mil steel sheets, this project used 18-mil steel sheets in Task 1 work. The monotonic tests on 18-mil sheets yielded reasonably lower strength compared to the published value of 18-mil sheets for wind loads. However the cyclic tests on 18-mil sheets gave significantly higher strength than the published value for 18-mil sheets for seismic loads, further investigation is therefore required to verify the published value.

In Task 2, a special seismic detailing was developed by a series of cyclic tests on 8-ft.×6-ft. shear walls with 2-in. fasteners at panel edges to prevent potential damage on the studs. The special detailing includes blocking and strapping at middle height and No. 10×3/4-in. self-drilling screws staggered at boundary and joint studs. It is also recommended to use a single stud at the sheet joint. The test results indicate that the special detailing will increase the nominal strength as well as improve the ductility of the shear wall. Apart from the special detailing, it was found that 8-ft.×6-ft. shear walls with 33-mil sheathing using 54-mil frame without the special detailing could also give satisfactory performance under cyclic loading. It can be concluded that the special seismic detailing shall be installed for 33-mil or 43-mil framed shear walls with steel sheathing thickness equal to or less than 33-mil. The nominal strength for representative shear walls with the special seismic detailing is established in Task 2.

The reduction factor due to the drift limit was calculated for the tested shear walls. It was found that the code reduction factor ($2w/h$) was conservative for the tested shear walls and future research is recommended to develop accurate equations for the drift reduction factor.

ACKNOWLEDGEMENT

The sponsorship of American Iron and Steel Institute and the donation of materials by Steel Stud Manufacturers Association and Nuconsteel Commercial Corp., Simpson Strong-Tie Company, Inc. are gratefully acknowledged. The assistance and guidance provided by the AISI COFS Lateral Design Task Group is highly appreciated. The assistance of the UNT lab technician Chris Matheson in setting up the testing apparatus has been invaluable. The authors would like to thank UNT undergraduate students, Kyle Durham, Devin Hyde, Travis Stivors, and Taylor Cheney, who prepared the test specimens. This project could not be completed without their contributions.

REFERENCES

- AISC 360 (2005). "Specification for Structural Steel Buildings," American Institute of Steel Construction, Chicago, IL.
- AISI S201 (2007). "North American Standard for Cold-Formed Steel Framing – Product Data, 2007 Edition," American Iron and Steel Institute, Washington, DC.
- AISI S213 (2007). "North American Standard for Cold-Formed Steel Framing – Lateral Design 2007 Edition," American Iron and Steel Institute, Washington, DC.
- AISI S230 (2007). "North American Standard for Cold-Formed Steel Framing – Prescriptive Method for One and Two Family Dwellings 2007 Edition," American Iron and Steel Institute, Washington, DC.
- ASCE 7 (2005) "Minimum Design Loads for Buildings And Other Structures: SEI/ASCE 7-05," American Society of Civil Engineers. Washington, DC.
- ASTM A370 (2006). "A370-06 Standard Test Methods and Definitions for Mechanical Testing of Steel Products," American Society for Testing and Materials, West Conshohocken, PA.
- ASTM E2126 (2007). "Standard Test Methods for Cyclic (Reversed) Load Test for Shear Resistance of Vertical Elements of the Lateral Force Resisting Systems for Buildings," American Society for Testing and Materials, West Conshohocken, PA.
- ASTM E564 (2006). "E564-06 Standard Practice for Static Load Test for Shear Resistance of Framed Walls for Buildings," American Society for Testing and Materials, West Conshohocken, PA.
- ASME B18.22.1 (1998). "Plan Washers," American Society of Mechanical Engineers, New York, NY.
- Ellis, J. (2007). "Shear Resistance of Cold-Formed Steel Framed Shear Wall Assemblies using CUREE Test Protocol," Simpson Strong-Tie Co., Inc.
- NASPEC (2007). "North American Specification for Design of Cold-Formed Steel Structural Members 2007 Edition," American Iron and Steel Institute, Washington, DC.
- Serrette, R.L., Nguyen, H., Hall, G. (1996). "Shear wall values for light weight steel framing," Report No. LGSRG-3-96, Santa Clara University, Santa Clara, CA.

- Serrette, R.L. (1997). "Additional Shear Wall Values for Light Weight Steel Framing," Report No. LGSRG-1-97, Santa Clara University, Santa Clara, CA.
- Serrette, R.L. (2002). "Performance of Cold-Formed Steel-Framed Shear Walls: Alternative Configurations," Final Report:LGSRG-06-02, Santa Clara University, Santa Clara, CA.
- Yu, C. (2007). "*Steel Sheet Sheathing Options for Cold-Formed Steel Framed Shear Wall Assemblies Providing Shear Resistance*", Report No. UNT-G76234 submitted to American Iron and Steel Institute, Washington, DC.

APPENDIX A – Data Sheets for Task 1 Tests

Test Label 8×2×350-33-27-2-C1

Test Date Sep. 12, 2008

Specimen Configuration

Wall dimensions: 8 ft. × 2 ft. Studs: 350S162-33 Tracks: 350T150-33 Steel sheathing: 0.027 in. 33ksi
Fastener: #8×18-1/2" modified truss head self-drilling screw, 2in. o.c. on the perimeter. Hold-down: Simpson Strong Tie S/HD10
Hold-down: Simpson Strong Tie S/HD10

Test protocol: Cyclic-SPD

Test results

Peak +load: 1648 lbs
Lateral displacement of wall top at
Peak +load: 2.60 in.

Peak -load: -1651 lbs
Lateral displacement of wall top at
Peak -load: -2.08 in.

Average peak load: 1649 lbs
Average lateral displacement: 2.34 in.

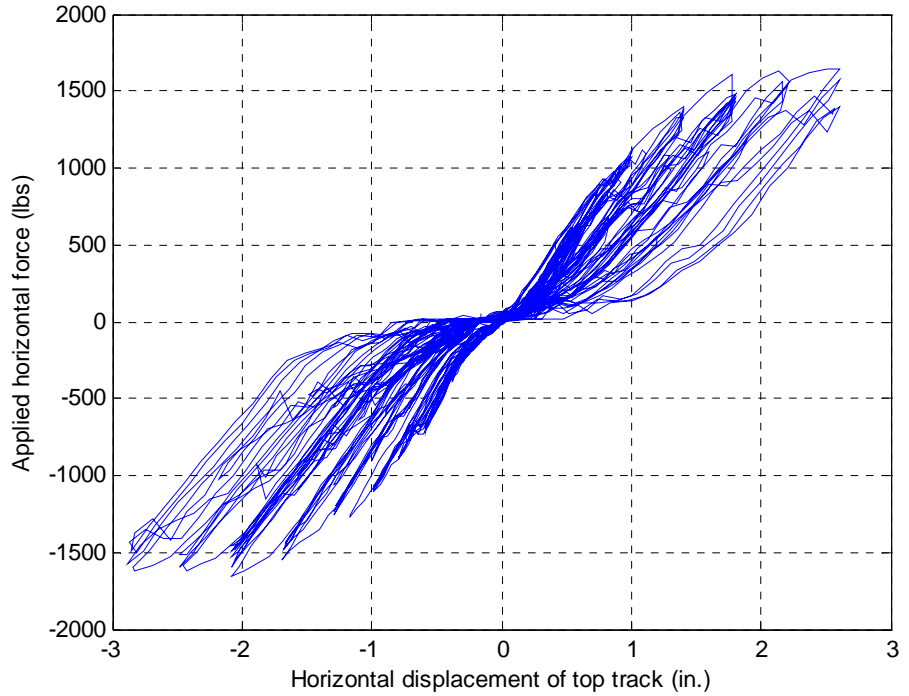

Observed Failure Mode: Steel sheet buckled; the chord studs distorted in the outer flanges.

Screw Pull Out: None

Sheathing Tear: None

Screw Pull Over: None

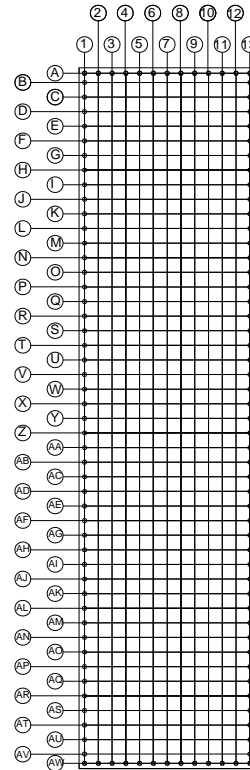



Test Label 8×2×350-33×27-6-M1

Test Date Sep. 12, 2008

Specimen Configuration

Wall dimensions: 8ft. × 2 ft. Studs: 350S162-33 Tracks: 350T150-33 Steel sheathing: 0.027 in 33 ksi.
Fastener: #8×18-1/2" modified truss head self-drilling tapping screw, 6 in. o.c. on perimeter. Hold-down: Simpson Strong Tie S/HD10

Test protocol: Monotonic-ASTM E564

Test results

Peak load: 1058 lbs
Lateral displacement of wall top at peak load: 1.95 in.

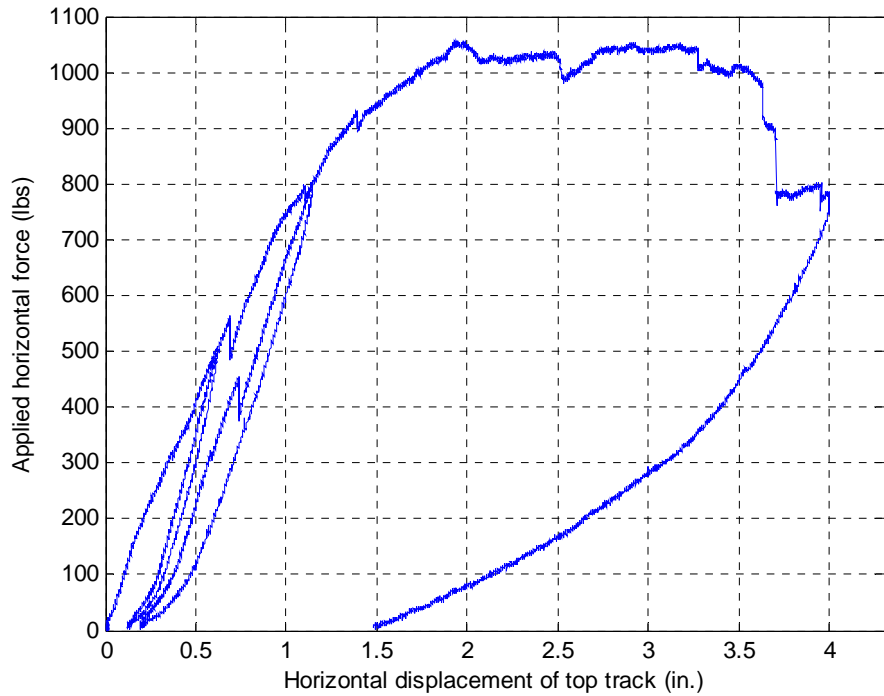

Observed Failure Mode: steel sheet buckled, screw pulled off the frame along the bottom portion of the chord studs.

Screw Pull Out: P1; O1

Sheathing Tear: Q1

Screw Pull Over: None

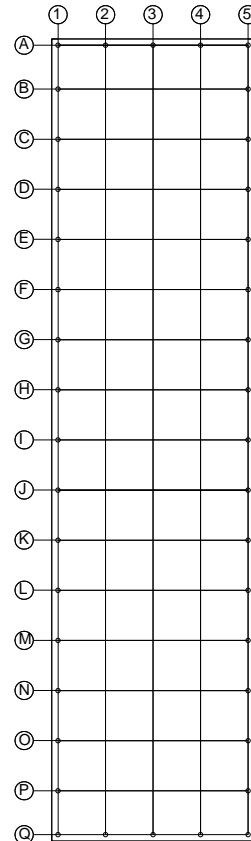



Test Label 8×2×350-33×27-6-M2

Test Date Sep. 15, 2008

Specimen Configuration

Wall dimensions: 8ft. × 2 ft. Studs: 350S162-33 Tracks: 350T150-33 Steel sheathing: 0.027 in. 33 ksi
Fastener: #8×18-1/2" modified truss head self-drilling tapping screw, 6 in. o.c. on perimeter. Hold-down: Simpson Strong Tie S/HD10

Test protocol: Monotonic-ASTM E564

Test results

Peak load: 1133 lbs
Lateral displacement at wall top of peak load: 2.62 in.

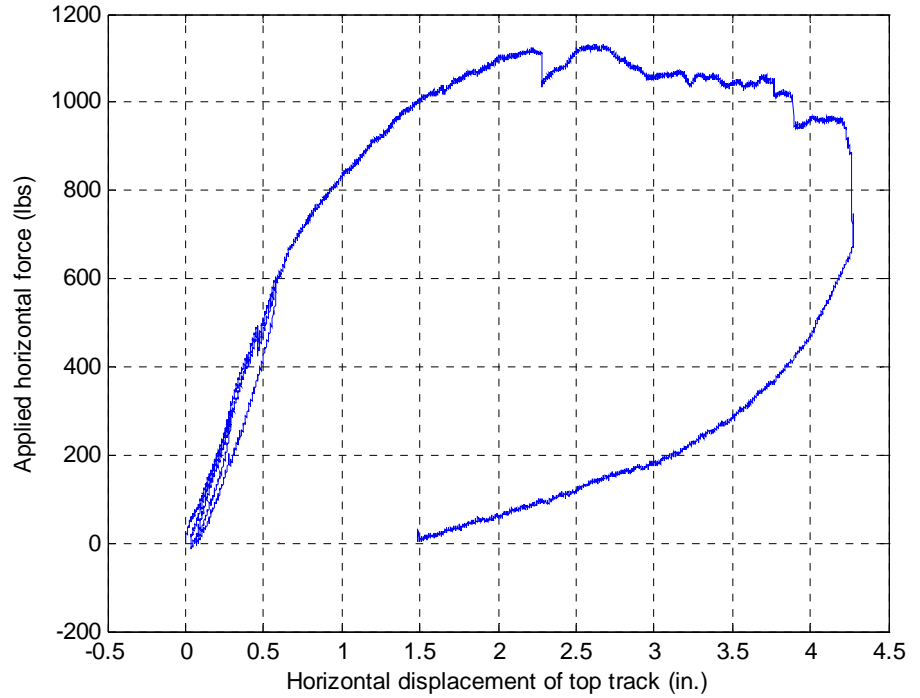

Observed Failure Mode: steel sheet buckled and screw pulled off the frame along the bottom portion of the chord studs.

Screw Pull Out: Q4;P5;O5;N5;M5;N5;L5

Sheathing Tear: Q5

Screw Pull Over: None

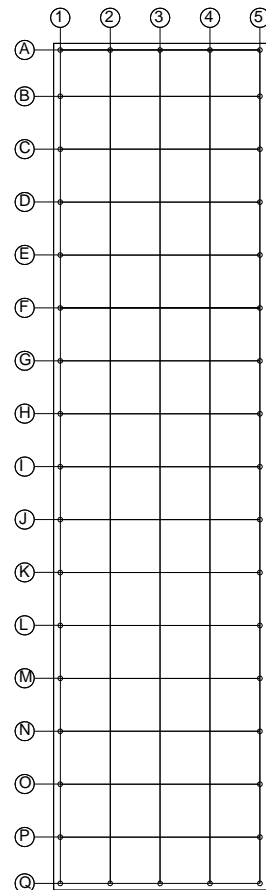



Test Label 8×2×350-33×27-6-C1

Test Date Sep. 17, 2008

Specimen Configuration

Wall dimensions: 8ft. × 2ft.

Studs: 350S162-33

Tracks: 350T150-33

Steel sheathing: 0.027 in. ksi

Fastener: #8×18-1/2" modified truss head self-drilling tapping screw, 6 in. o.c. on perimeter. Hold-down: Simpson Strong Tie S/HD10

Test protocol: Cyclic-CUREE

Test results

Peak +load: 1204 lbs

Lateral displacement of wall top at

Peak +load: 2.87 in.

Peak -load: -1455 lbs

Lateral displacement of wall top at

Peak -load: -2.32 in.

Average peak load: 1330 lbs

Average lateral displacement: 2.59

in.

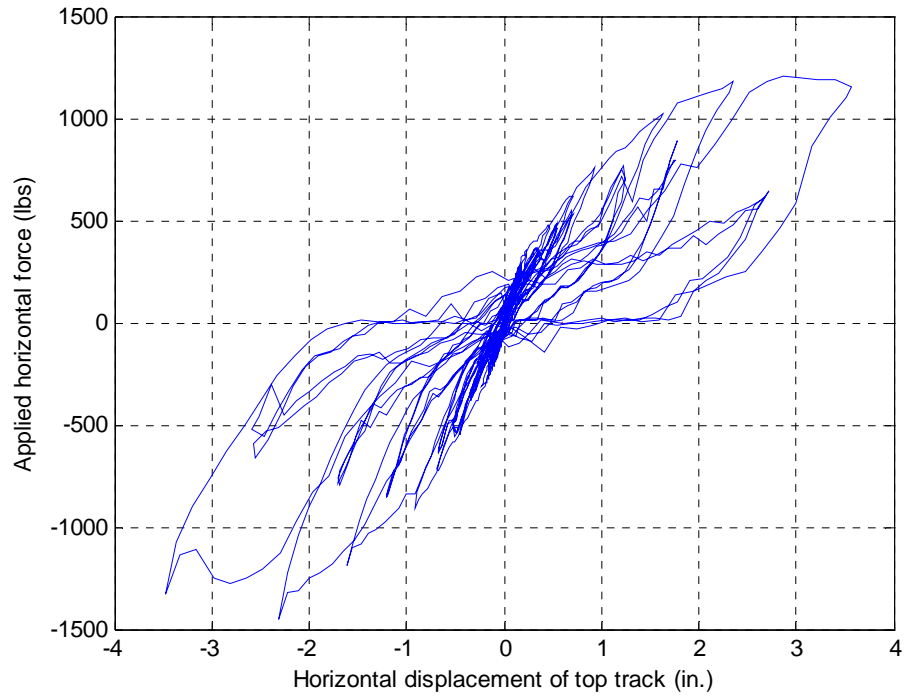

Observed Failure Mode: steel sheet buckled and screw pulled off the frame along the bottom portion of the chord studs.

Screw Pull Out: P5;O5;N5;M5;A5;B5;C5;D5;A4

Sheathing Tear: Q5

Screw Pull Over: None

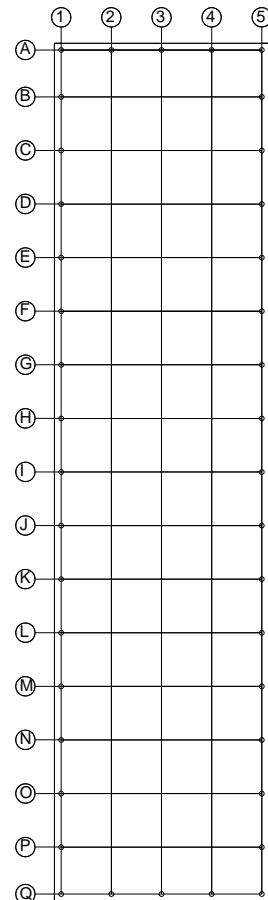



Test Label 8×2×350-33×27-6-C2

Test Date Sep. 18, 2008

Specimen Configuration

Wall dimensions: 8ft. × 2 ft. Studs: 350S162-33 Tracks: 350T150-33 Steel sheathing: 0.027 in. 33 ksi
Fastener: #8×18-1/2" modified truss head self-drilling screw, 6 in. o.c. on the perimeter. Hold-down: Simpson Strong Tie S/HD10

Test protocol: Cyclic-CUREE

Test results

Peak +load: 1472 lbs
Lateral displacement of wall top at
Peak +load: 3.35 in.

Peak -load: -1203 lbs
Lateral displacement of wall top at
Peak -load: -1.99 in.

Average peak load: 1338 lbs
Average lateral displacement: 2.67 in.

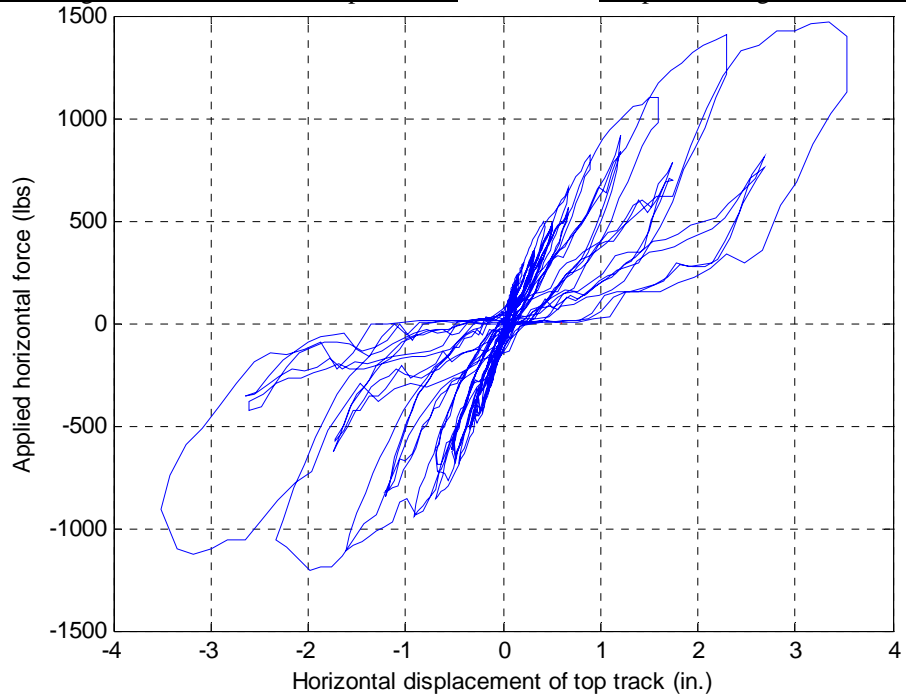

Observed Failure Mode: steel sheet buckled and screw pulled off the frame along the both bottom portion of the chord studs and top of the chord stud.

Screw Pull Out: P1;P5;O1;N1;Q2;Q3;B1;A2

Sheathing Tear: Q1;A1

Screw Pull Over: None

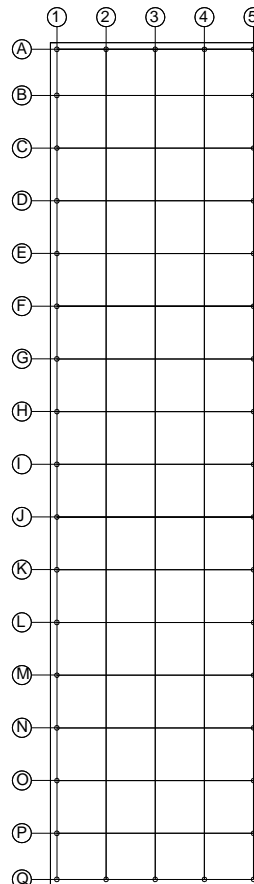



Test Label 8×4×350-33×17-6-M1

Test Date Nov. 14, 2008

Specimen Configuration

Wall dimensions: 8 ft. × 4 ft. Studs: 362S162-33 Tracks: 350T150-33

Steel sheathing: 0.017 in. 33 ksi

Fastener: #8×18-1/2" modified truss head self-drilling screw, 6in. o.c. on the perimeter. Hold-down: Simpson Strong Tie S/HD10

Test protocol: Monotonic-ASTM E564

Test results

Peak load: 1709 lbs

Lateral displacement of wall top at peak load: 2.10 in.

Lateral displacement of wall top at peak load: 2.10 in.

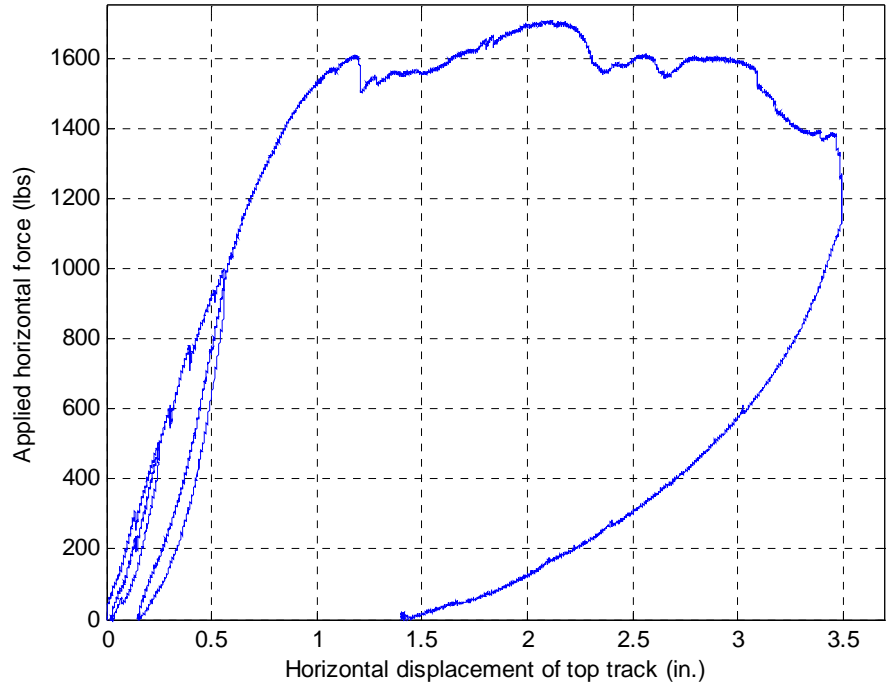

Observed Failure Mode: Steel sheet buckled, the chord studs distorted on the flange at top, the interior stud distorted on flange at center.

Screw Pull Out: C5;O5;K5

Sheathing Tear:

A1;A2;A3;A4;B1;N9;O9;P9;Q9;Q8

Screw Pull Over: A13

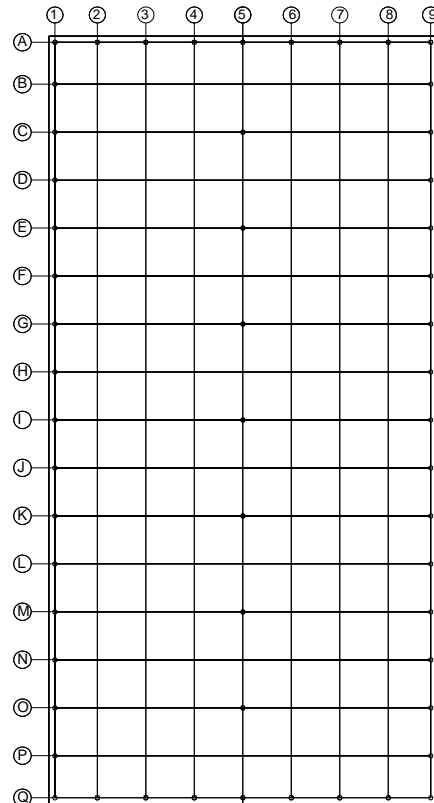

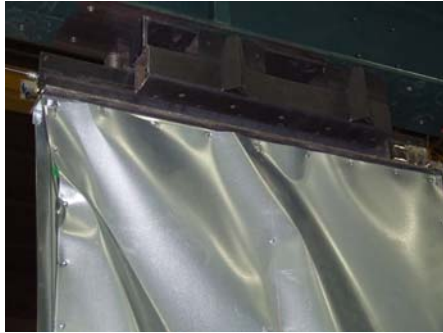

Test Label 8×4×350-33×17-6-M2

Test Date July, 17, 2009

Specimen Configuration

Wall dimensions: 8 ft. × 4 ft.

Studs: 362S162-33

Tracks: 350T150-33

Steel sheathing: 0.017 in. 33 ksi

Fastener: #8×18-1/2" modified truss head self-drilling screw, 6in. o.c. on the perimeter. Hold-down: Simpson Strong Tie S/HD10

Test protocol: Monotonic-ASTM E564

Test results

Peak load: 1883 lbs

Lateral displacement of wall top at peak load: 1.25 in.

Peak load: 1.25 in.

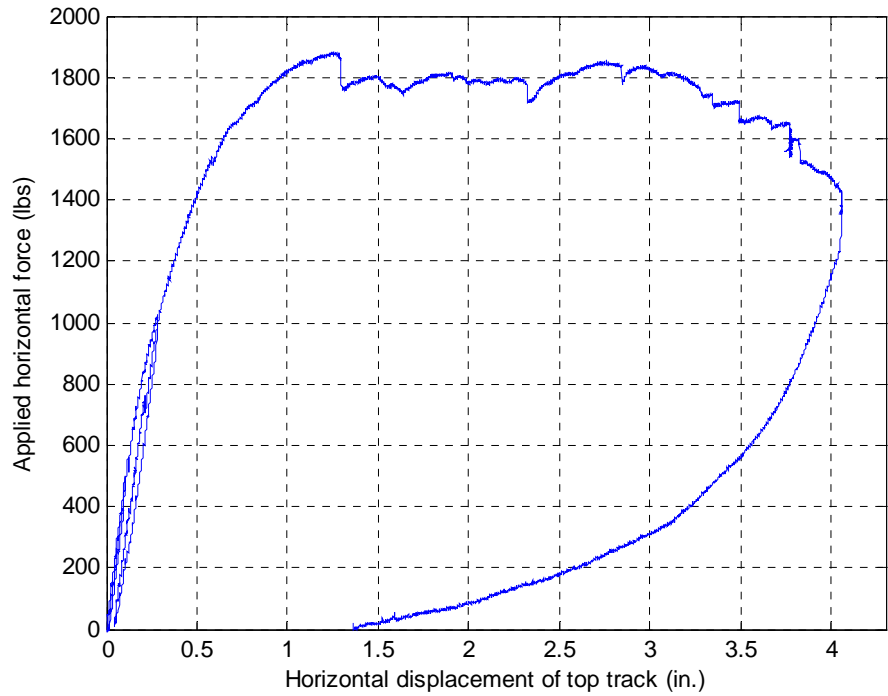

Observed Failure Mode: Steel sheet buckled and screw pulled off the frame at the left top corner.

Screw Pull Out: B1;C1

Sheathing Tear: A1;A2;A3;A4

Screw Pull Over: A5

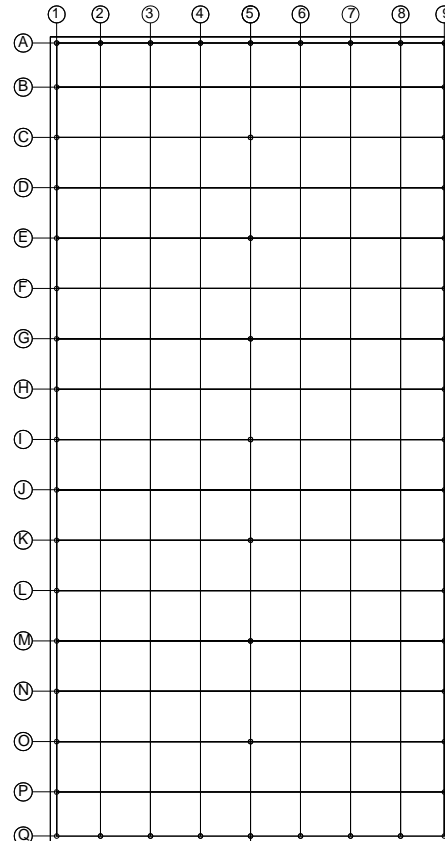



Test Label 8×4×350-33×17-6-C1

Test Date December 08, 2008

Specimen Configuration

Wall dimensions: 8 ft. × 4 ft. Studs: 350S162-33 Tracks: 350T150-33 Steel sheathing: 0.017 in. 33 ksi
Fastener: #8×18-1/2" modified truss head self-drilling tapping screw, 6 in. o.c. on the perimeter. Hold-down: Simpson Strong Tie S/HD10

Test protocol: Cyclic-CUREE

Test results

Peak +load: 1957 lbs
Lateral displacement of wall top at
Peak +load: 1.15 in.

Peak -load: -1963 lbs
Lateral displacement of wall top at
Peak -load: -1.40 in.

Average peak load: 1960 lbs
Average lateral displacement: 1.27 in.

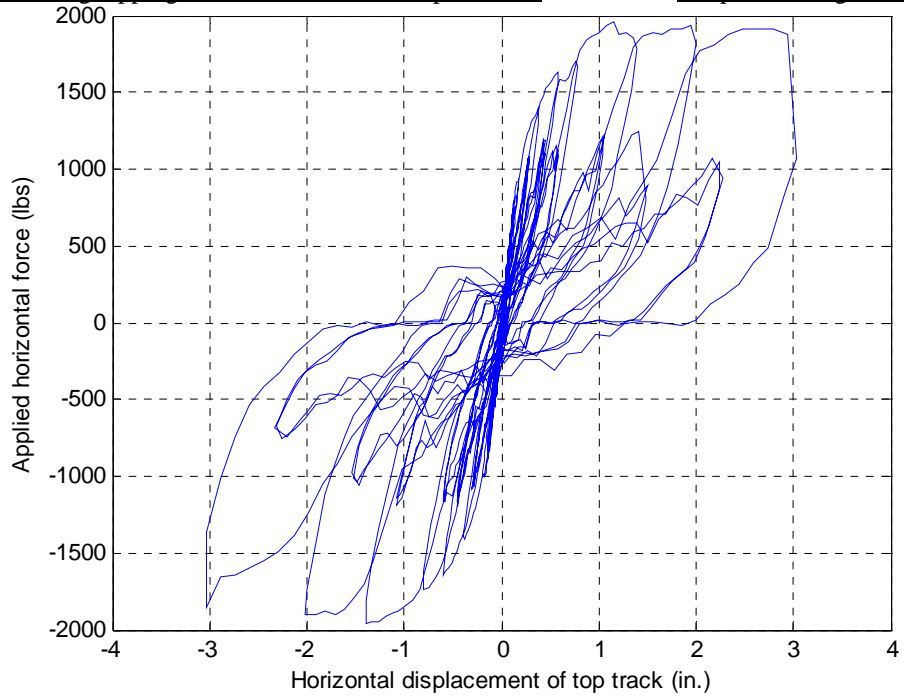

Observed Failure Mode: steel sheet buckled and screw pulled off the frame along the both bottom portion of the chord studs and at the center of the single stud.

Screw Pull Out: D1;A2;B9;M5;K5;I5

Sheathing Tear:

A13;A3;A8;C9;Q9;Q8;Q7;P9;O9;Q1;P1;Q2

Screw Pull Over: A1;B1;C1;A9

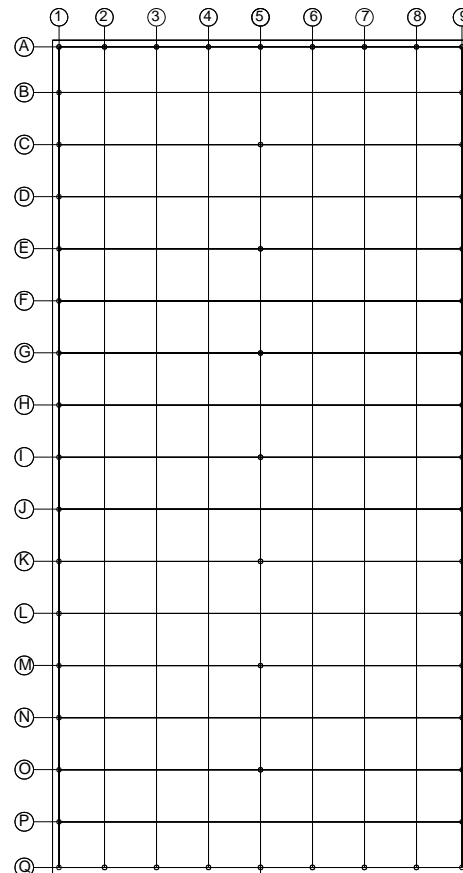



Test Label 8×4×350-33×17-6-C2

Test Date July 20, 2009

Specimen Configuration

Wall dimensions: 8 ft. × 4 ft.

Studs: 350S162-33

Tracks: 350T150-33

Steel sheathing: 0.017 in. 33 ksi

Fastener: #8×18-1/2" modified truss head self-drilling tapping screw, 6 in. o.c. on the perimeter. Hold-down: Simpson Strong Tie S/HD10

Test protocol: Cyclic-CUREE

Test results

Peak +load: 2048 lbs

Lateral displacement of wall top at

Peak +load: 1.00 in.

Peak -load: -2145 lbs

Lateral displacement of wall top at

Peak -load: -1.60 in.

Average peak load: 2097 lbs

Average lateral displacement: 1.30

in.

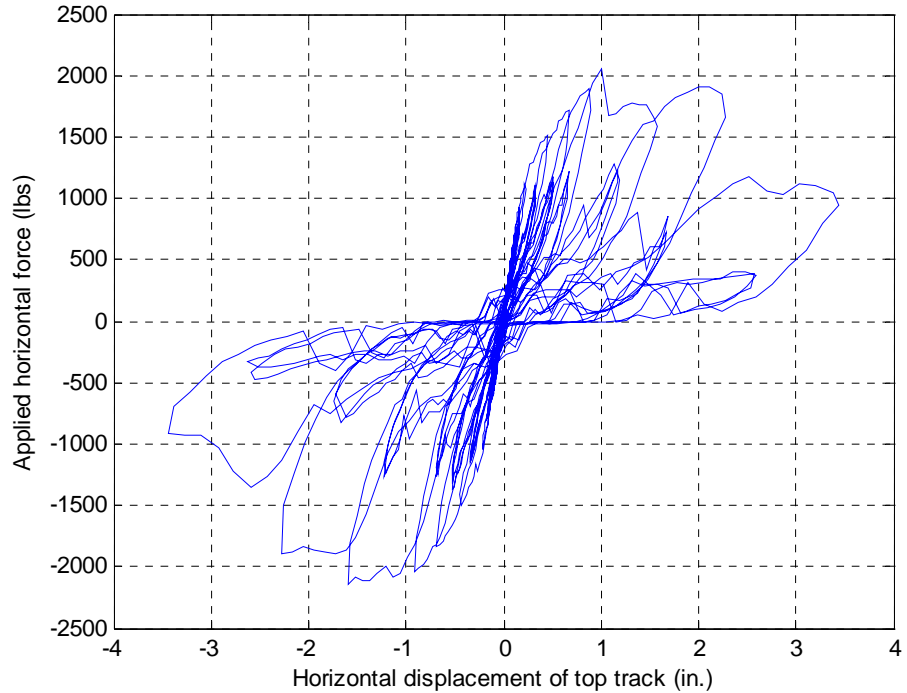

Observed Failure Mode: steel sheet buckled, screw pulled out from the top track and the mid-height of the single stud.

Screw Pull Out: A1;B1;C1;D1;Q9;P9;C5;E5

Sheathing Tear: A9;Q1

Screw Pull Over:

A2;A3;A4;A5;A6;A7;A8;B9;C9;G5;I5;K5

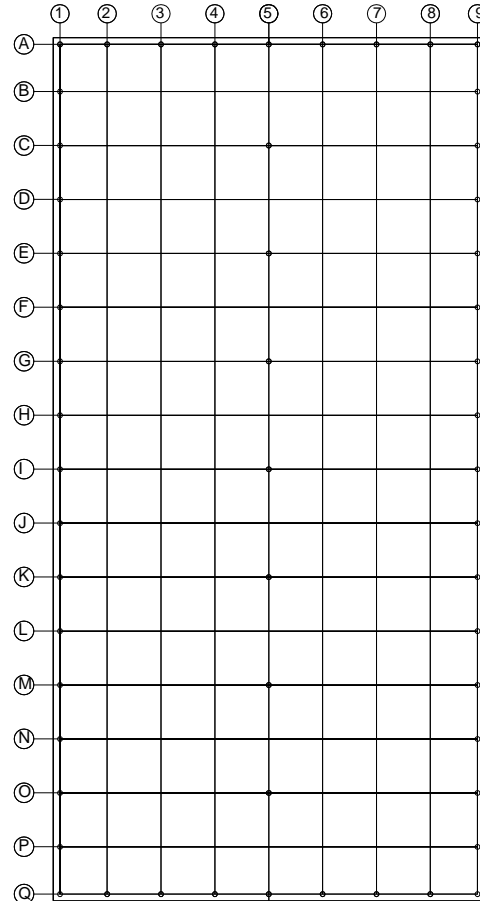

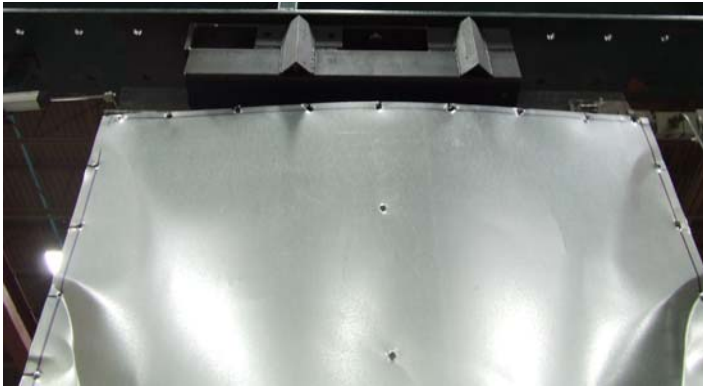

Test Label 8×2×350-33×27-2-M1

Test Date December 9, 2008

Specimen Configuration

Wall dimensions: 8 ft. × 2 ft. Studs: 350S162-33 Tracks: 350T150-33 Steel sheathing: 0.027 in. 33 ksi
Fastener: #8×18-1/2" modified truss head self-drilling screw, 2 in. o.c. on the perimeter. Hold-down: Simpson Strong Tie S/HD10

Test protocol: Monotonic-ASTM E564

Test results

Peak load: 1730 lbs

Net lateral displacement at top of wall: 2.15 in.

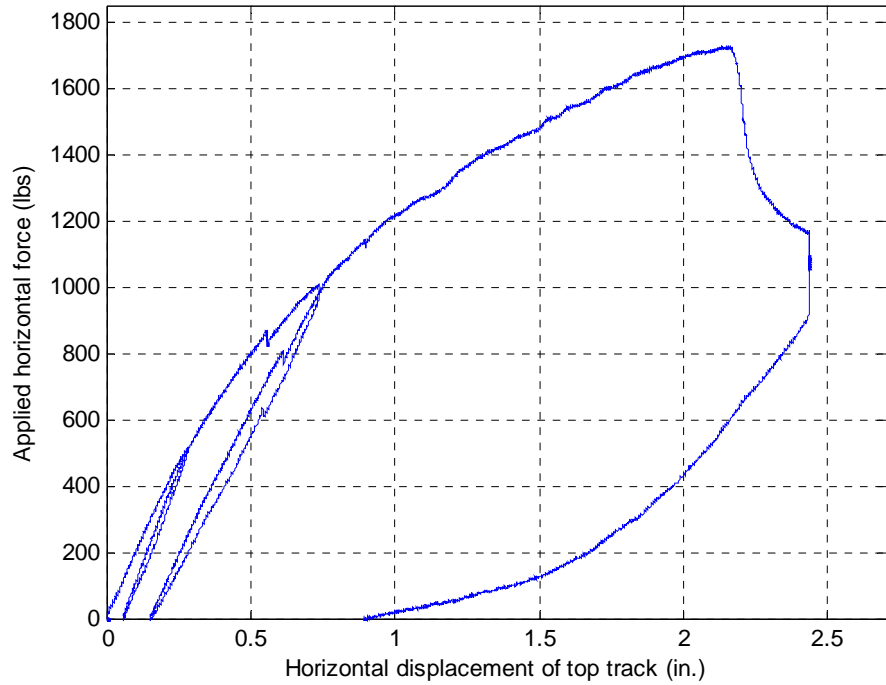

Observed Failure Mode: Steel sheet buckled, boundary studs buckled on the compression side of the wall.

Screw Pull Out: None

Sheathing Tear: None

Screw Pull Over: None

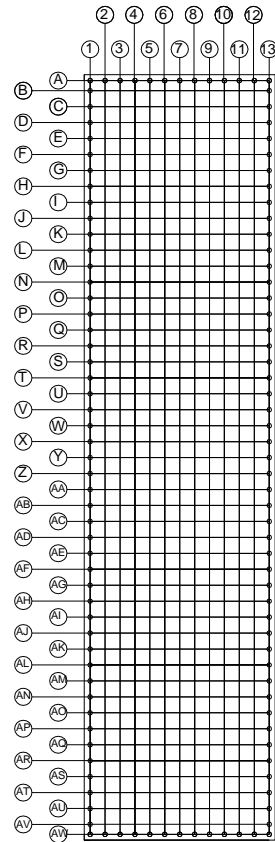



Test Label 8×2×350-33×27-2-C2

Test Date December 10, 2008

Specimen Configuration

Wall dimensions: 8 ft. × 2 ft. Studs: 350S162-33 Tracks: 350T150-33 Steel sheathing: 0.027 in. 33 ksi
 Fastener: #8×18-1/2" modified truss head self-drilling tapping screw, 2 in. o.c. on the perimeter. Hold-down: Simpson Strong Tie S/HD10

Test protocol: Cyclic-CUREE

Test results

Peak +load: 1787 lbs
 Lateral displacement of wall top at Peak +load: 2.55 in.

Peak -load: -1607 lbs
 Lateral displacement of wall top at Peak -load: -2.37 in.

Average peak load: 1697 lbs
 Average lateral displacement: 2.46 in.

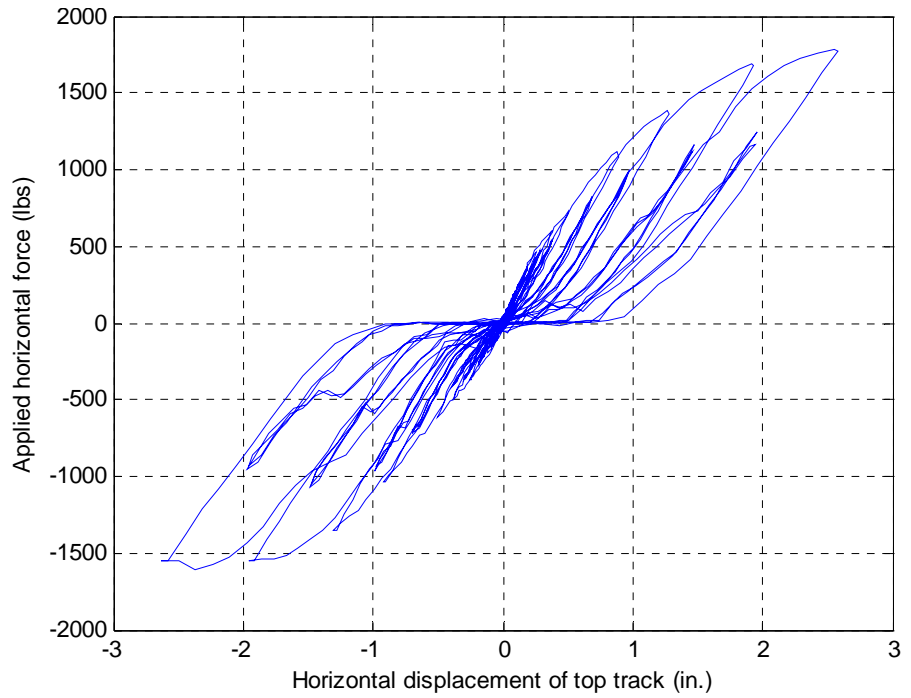

Observed Failure Mode: steel sheet buckled, distortion on flanges of boundary studs

Screw Pull Out: AV13

Sheathing Tear: None

Screw Pull Over: None

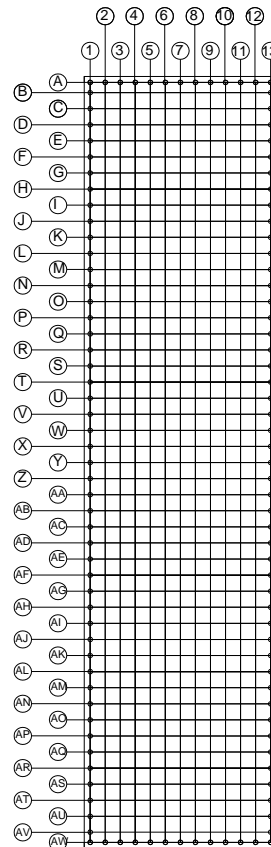



Test Label 8×2×350-33×27-2-C3

Test Date December 10, 2008

Specimen Configuration

Wall dimensions: 8 ft. × 2 ft. Studs: 350S162-33 Tracks: 350T150-33 Steel sheathing: 0.027 in. 33 ksi
Fastener: #8×18-1/2" modified truss head self-drilling tapping screw, 2 in. o.c. on the perimeter. Hold-down: Simpson Strong Tie S/HD10

Test protocol: Cyclic-CUREE

Test results

Peak +load: 1919 lbs
Lateral displacement of wall top at
Peak +load: 1.91 in.

Peak -load: -1727 lbs
Lateral displacement of wall top at
Peak -load: -1.68 in.

Average peak load: 1823 lbs
Average lateral displacement: 1.79 in.

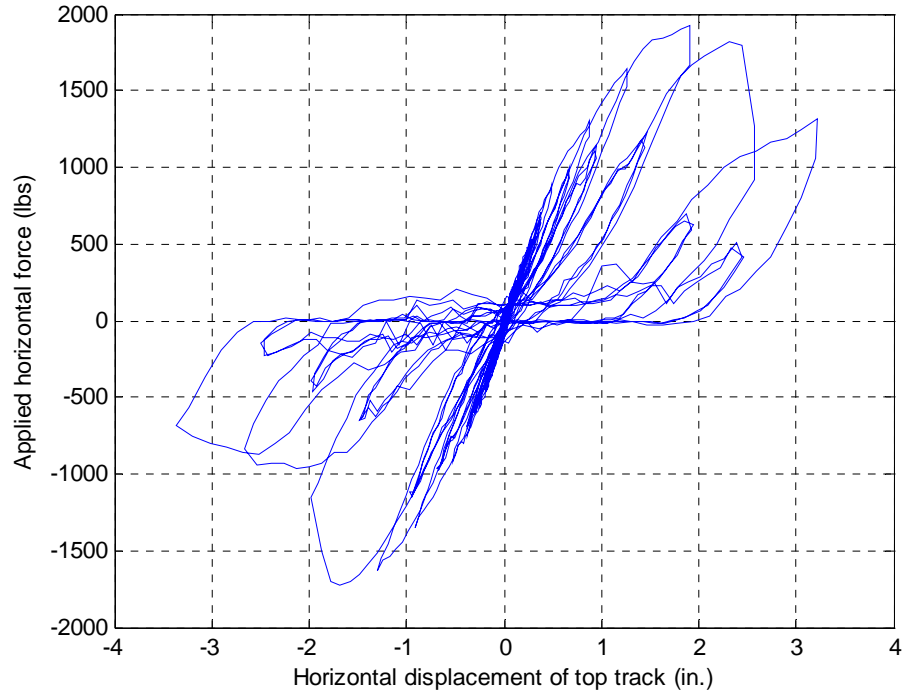

Observed Failure Mode: steel sheet buckled, boundary studs buckled at bottom.

Screw Pull Out: None

Sheathing Tear: None

Screw Pull Over: None

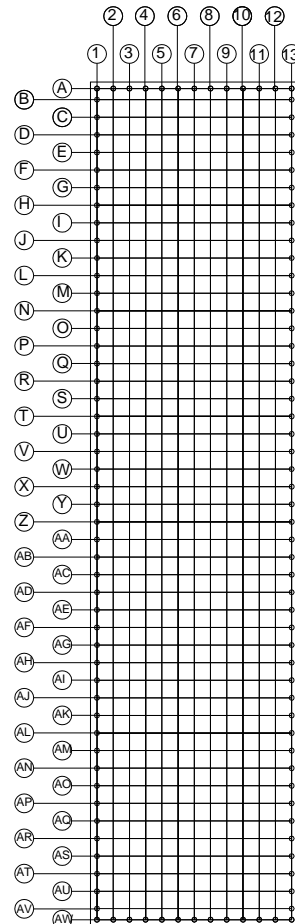



APPENDIX B – Data Sheets for Task 2 Tests

Test Label 8x6x350-43x30-2-C1-A

Test Date Sep. 29, 2008

Specimen Configuration

Wall dimensions: 8ft. x 6 ft. Studs: 350S162-43 Tracks: 350T150-43 Steel sheathing: 0.030 in. 33 ksi
 Fastener: #8x18-1/2" modified truss head self-drilling tapping screw, 2 in. o.c. on the perimeter. Hold-down: Simpson Strong Tie S/HD10

Test protocol: Cyclic-CUREE

Test results

Peak +load: 6304 lbs
 Lateral displacement of wall top at
 Peak +load: 1.03 in.

Peak -load: -6240 lbs
 Lateral displacement of wall top at
 Peak -load: -1.68 in.

Average peak load: 6272 lbs
 Average lateral displacement: 1.35 in.

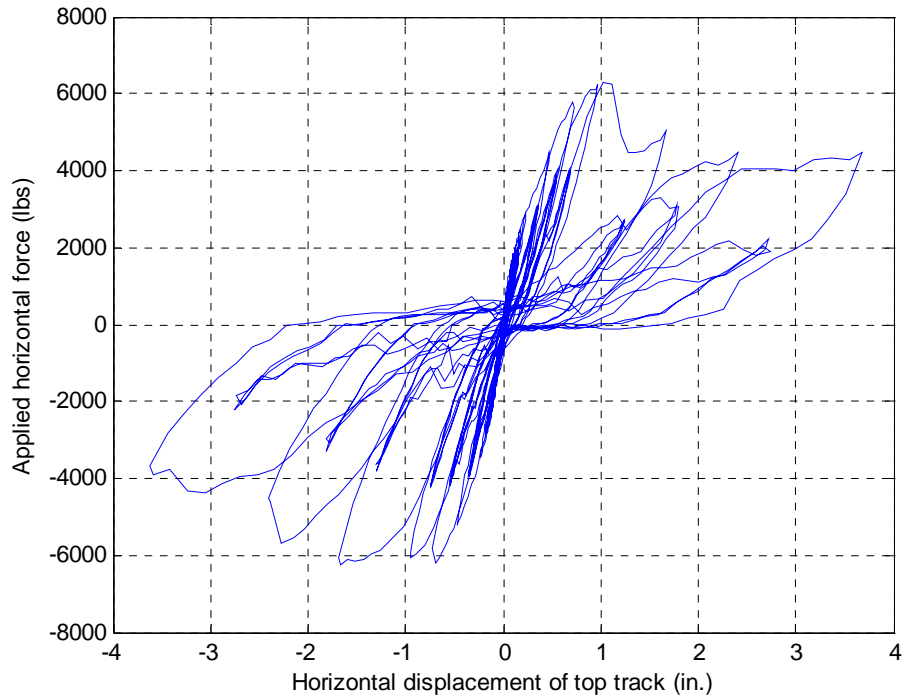

Observed Failure Mode: steel sheet buckled and pulled off the frame along the bottom portion of the chord studs and the bottom track, the single stud buckled and the interior double studs separated.

Screw Pull Out:

AW2;AW3;AW4;AW5;AW6;AP1;AQ1;AR1;
 AS1;AT1;AU1;AV1;AQ13;AK13;Y13;S13;
 AW24;AW23;AW22;AW21;AW20;AV25;AU25

Sheathing Tear: None

Screw Pull Over: None

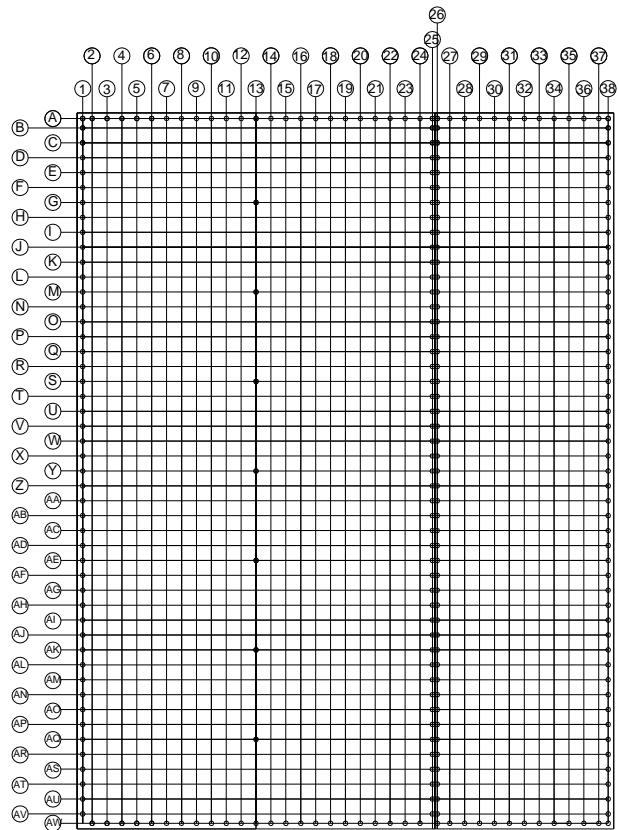

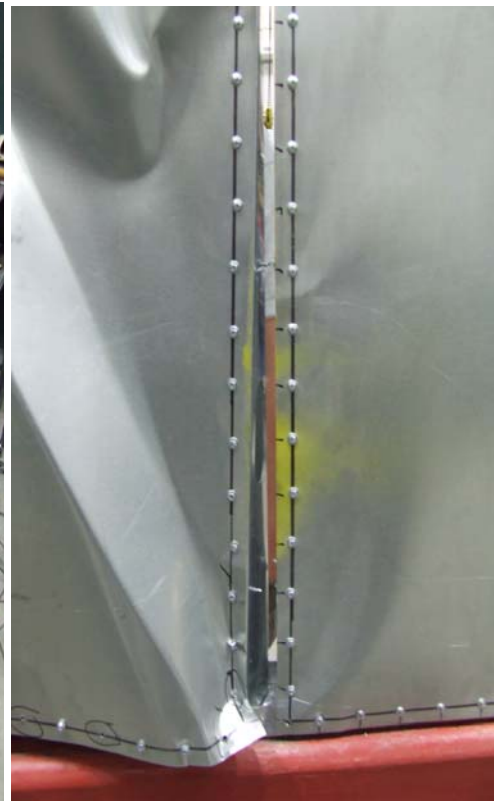

Test Label 8x6x350-43x30-2-C1-B

Test Date Oct.03, 2008

Specimen Configuration

Wall dimensions: 8ft. x 6 ft. Studs: 350S162-43 Tracks: 350T150-43 Steel sheathing: 0.030 in. 33 ksi
 Fastener: #8x18-1/2" modified truss head self-drilling tapping screw, 2 in. o.c. on the perimeter. Hold-down: Simpson Strong Tie S/HD10

Test protocol: Cyclic-CUREE

Test results

Peak +load: 7577 lbs
 Lateral displacement of wall top at Peak +load: 1.36 in.

Peak -load: -7339 lbs
 Lateral displacement of wall top at Peak -load: -1.61 in.

Average peak load: 7458 lbs
 Average lateral displacement: 1.49 in.

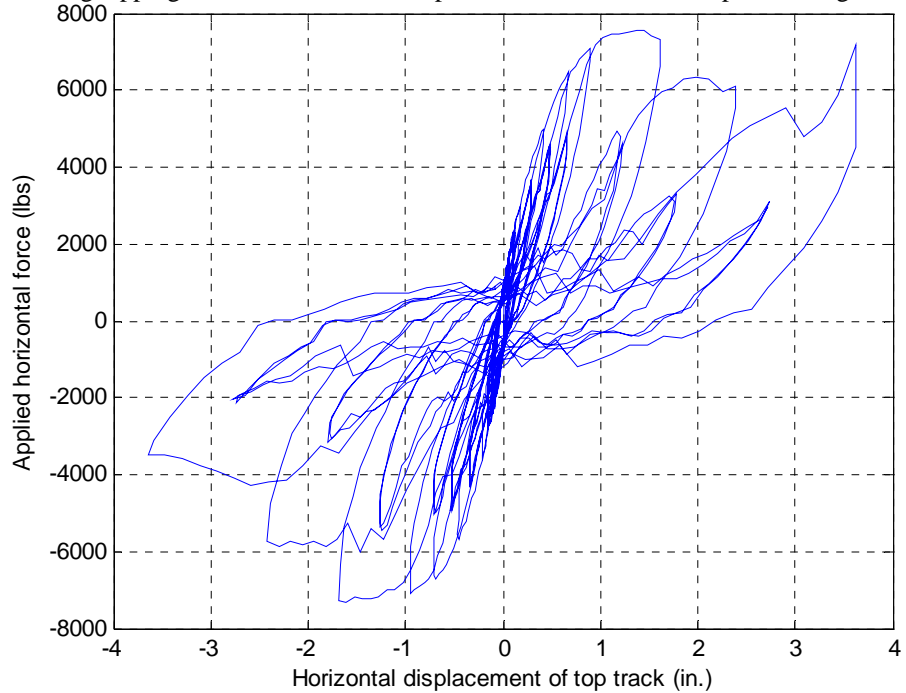

Observed Failure Mode: steel sheet buckled, screw pulled out at corners of the panel, two interior studs buckled.

Screw Pull Out:

AW35;AW36;AU38;AT38;AS38;AR38;AQ38;AK26;AE26;Y26;S26;G26;M26;AW15;AF13;AE13;AD13;AW2;AW3;AW4;AR1;AS1;AT1;AU1;AV1;A13;B1;C1;D1;E1;F1;G1;H1;A3;A4;A5;A6;B38

Sheathing Tear: None

Screw Pull Over: AW37;AV38;AW1;A2

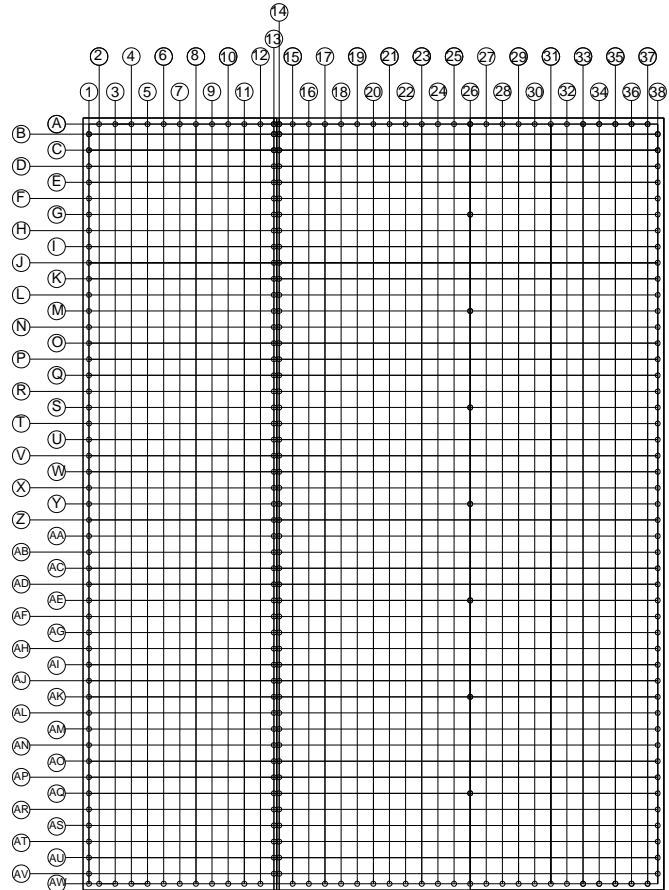



Test Label 8x6x350-43x33-2-M1-C

Test Date February 3, 2009

Specimen Configuration

Wall dimensions: 8 ft. x 6 ft. Studs: 350S162-43 Tracks: 350T125-43 Steel sheathing: 0.033 in. 33 ksi;
Blocking: 350T125-43 Strapping: 33ksi 1 1/2" x 33mil
Fastener: #10x18-3/4" modified truss head self-drilling screw, 2 in. o.c. on the perimeter. Hold-down: Simpson Strong Tie S/HD10

Test protocol: Monotonic-ASTM E564

Test results

Peak load: 7287 lbs
Lateral displacement at top of wall: 1.74 in.

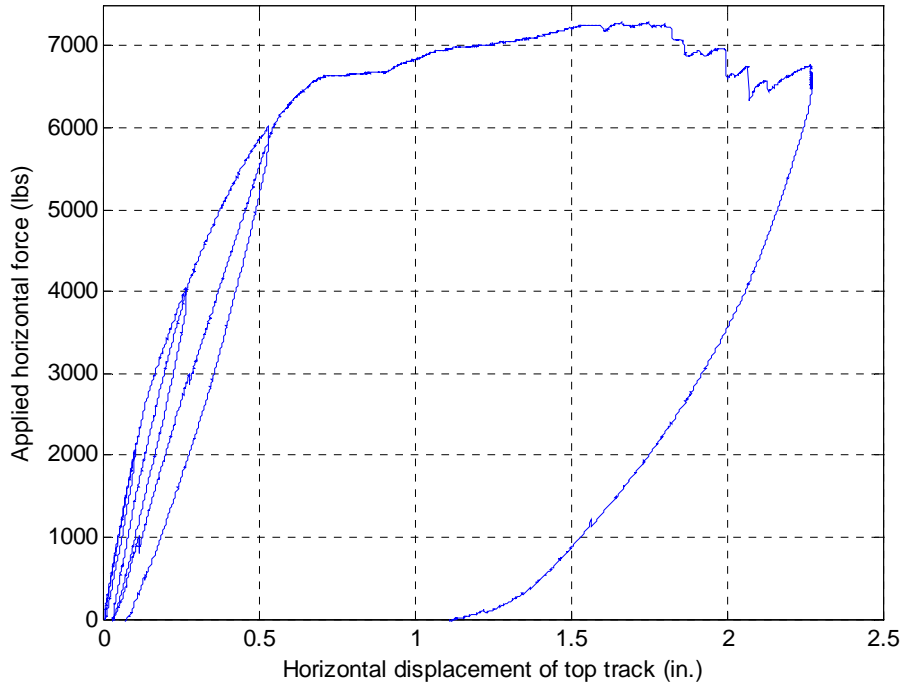

Observed Failure Mode: Steel sheet buckled, screws pulled out at center of interior stud, flange of chord studs distorted

Screw Pull Out:

AS38;AT38;AU38;AV38;AW38;AW37;AW36; AW35

Sheathing Tear: None

Screw Pull Over: None

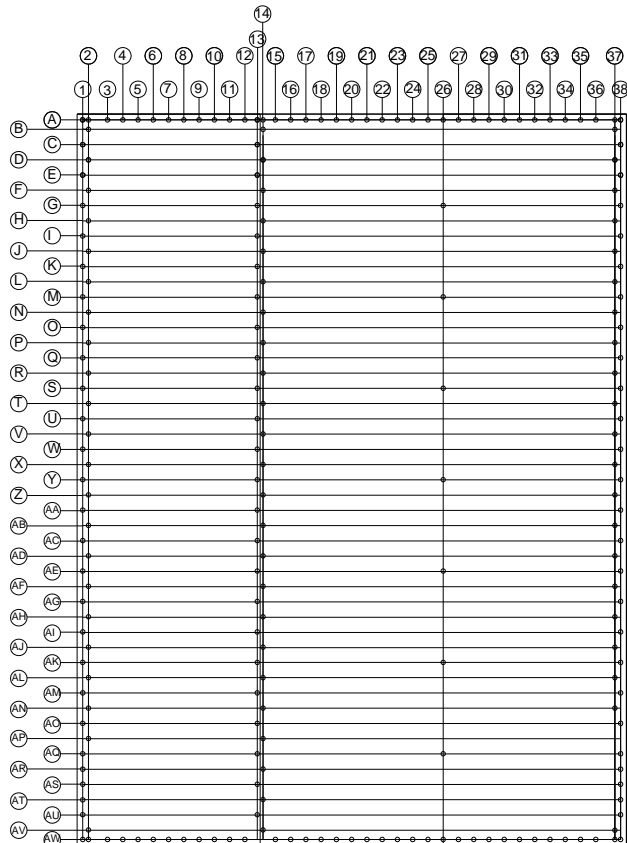



Test Label 8x6x350-43x33-2-C1-C

Test Date February 5, 2009

Specimen Configuration

Wall dimensions: 8 ft. x 6 ft. Studs: 350S162-43 Tracks: 350T125-43 Steel sheathing: 0.033 in. 33 ksi;
 Blocking: 350T125-43 Strapping: 33ksi 1 1/2" x 33mil
 Fastener: #10-3/4" modified truss head self-drilling tapping screw, 2 in. o.c. on the perimeter. Hold-down: Simpson Strong Tie S/HD10

Test protocol: Cyclic-CUREE

Test results

Peak +load: 9450 lbs
 Lateral displacement of wall top at
 Peak +load: 1.07 in.

Peak -load: -8894 lbs
 Lateral displacement of wall top at
 Peak -load: -1.13 in.

Average peak load: 9172 lbs
 Average lateral displacement: 1.10 in.

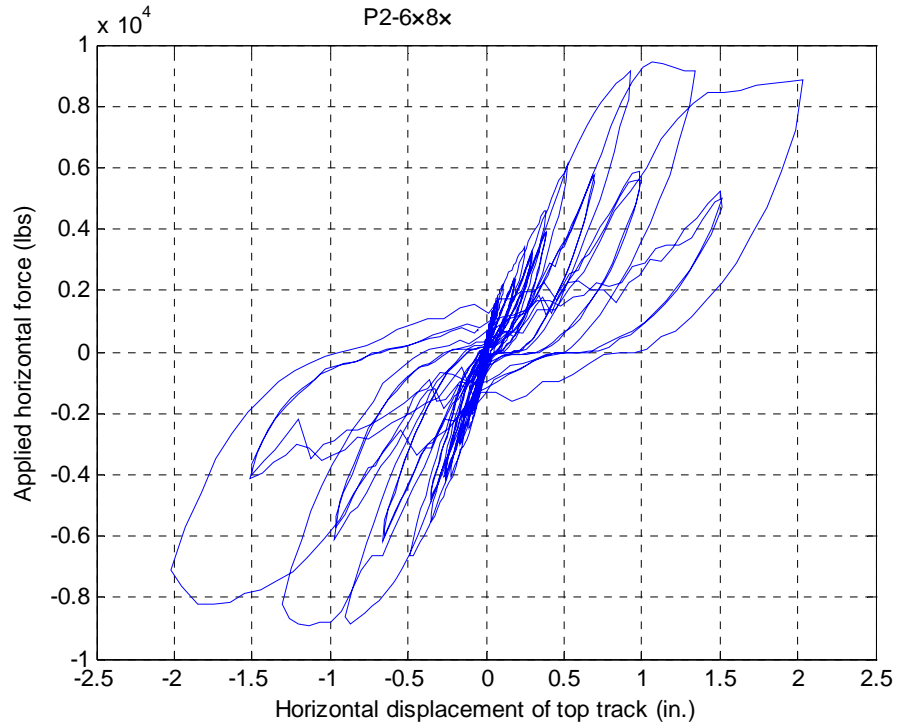

Observed Failure Mode: steel sheet buckled, screws pulled out at the bottom of joint stud and mid-height of field stud.

Screw Pull Out:

AV14;AT14;AR14;AP14;AW15;AW16;AW36;AQ
 26;AK26; AE26

Sheathing Tear: None

Screw Pull Over: None

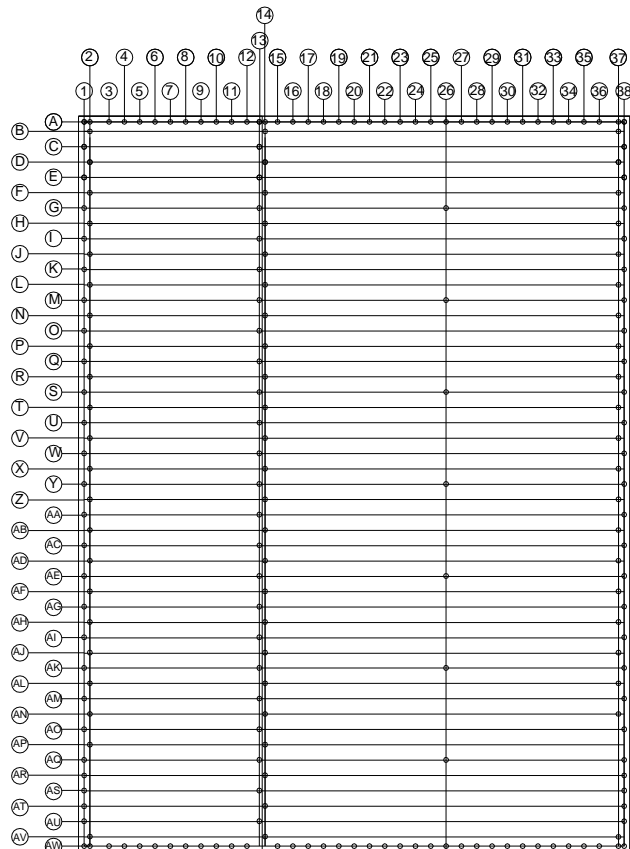



Test Label 8x6x350-43x33-2-C2-C

Test Date February 10, 2009

Specimen Configuration

Wall dimensions: 8 ft. x 6 ft. Studs: 350S162-43 Tracks: 350T125-43 Steel sheathing: 0.033 in. 33 ksi
Blocking: 350T125-43 Strapping: 33ksi 1 1/2" x 33mil
Fastener: #10-3/4" modified truss head self-drilling tapping screw, 2 in. o.c. on the perimeter. Hold-down: Simpson Strong Tie S/HD10

Test protocol: Cyclic-CUREE

Test results

Peak +load: 9166 lbs
Lateral displacement of wall top at Peak +load: 1.21 in.

Peak -load: -8652 lbs
Lateral displacement of wall top at Peak -load: -1.33 in.

Average peak load: 8909 lbs
Average lateral displacement: 1.27 in.

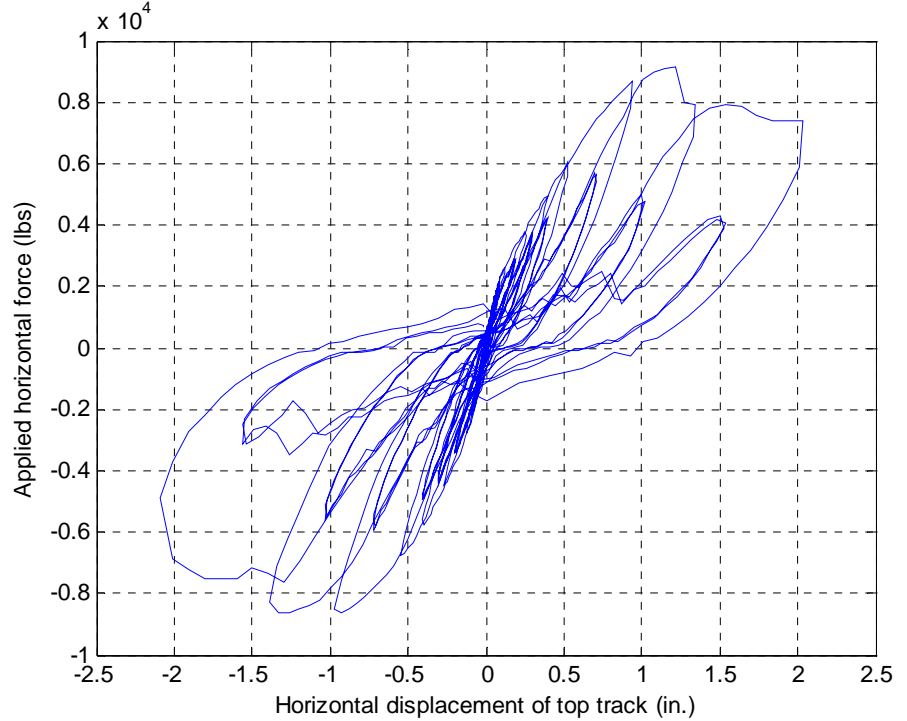

Observed Failure Mode: steel sheet buckled, screws pulled out at the bottom of joint stud and mid-height of field stud.

Screw Pull Out:

AW37;AW36;AW35;AW14;AT14;AR14;AP14;AN14;AE26;Y26;S26

Sheathing Tear: None

Screw Pull Over: AW38

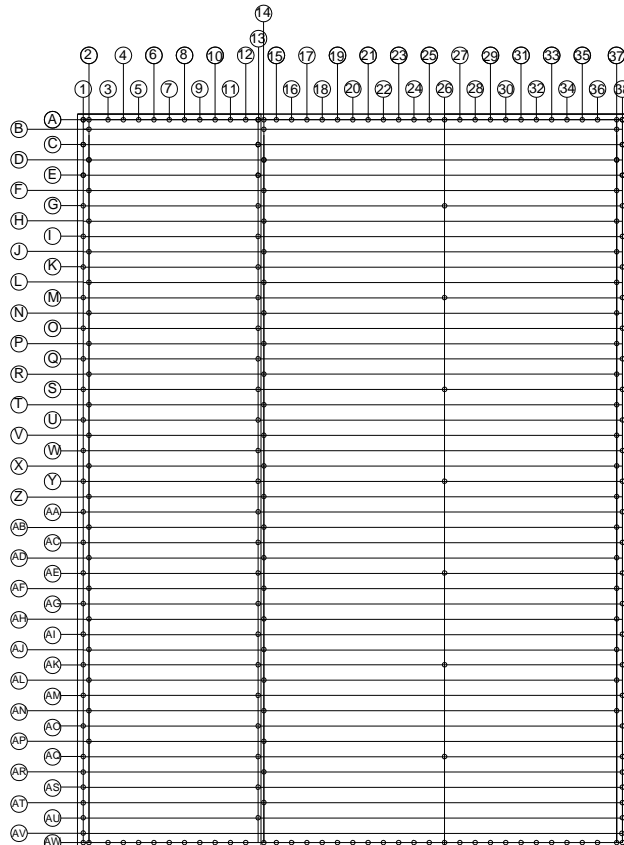



Test Label 8x6x350-43x30-2-M1-C

Test Date March 18, 2009

Specimen Configuration

Wall dimensions: 8 ft. x 6 ft. Studs: 350S162-43 Tracks: 350T150-43 Steel sheathing: 0.030 in. 33 ksi;
Blocking: 350T150-43 Strapping: 33ksi 1 1/2" x 33mil
Fastener: #10x3/4" modified truss head self-drilling screw, 2 in.o.c. (stagger) on the perimeter; Hold-down: Simpson Strong Tie S/HD10

Test protocol: Monotonic-ASTM E564

Test results

Peak load: 7527 lbs
Lateral displacement of wall top at peak load: 1.41 in.

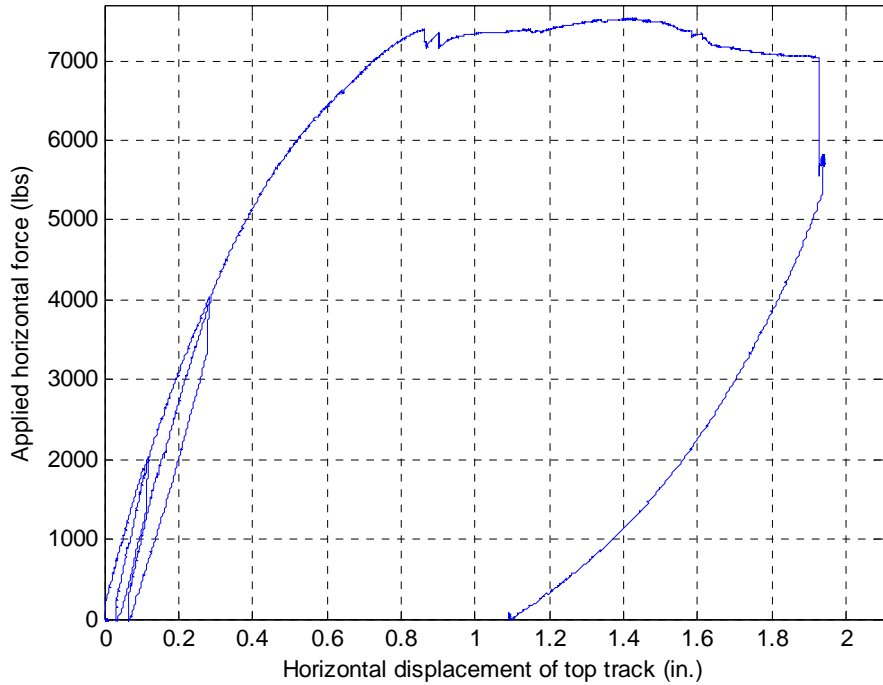

Observed Failure Mode: Steel sheet buckled, screw pulled out at mid height of studs.

Screw Pull Out:

AW35;AW36;Y26;S26;AE26;V14;T14

Sheathing Tear: None

Screw Pull Over: None

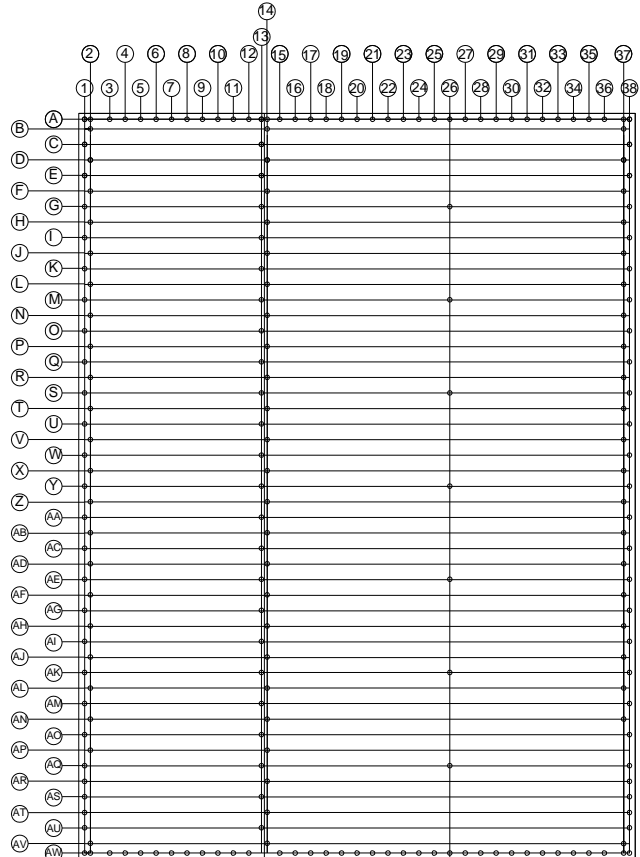



Test Label 8x6x350-43x30-2-C1-C

Test Date March 19, 2009

Specimen Configuration

Wall dimensions: 8 ft. x 6 ft. Studs: 350S162-43 Tracks: 350T150-43 Steel sheathing: 0.030 in. 33 ksi
Blocking: 350T150-43 Strapping: 33ksi 1 1/2" x 33mil
Fastener: #10x3/4" modified truss head self-drilling screw, 2 in.o.c. (stagger) on the perimeter; Hold-down: Simpson Strong Tie S/HD10

Test protocol: Cyclic-CUREE

Test results

Peak +load: 7760 lbs
Lateral displacement of wall top at Peak +load: 1.33 in.

Peak -load: -8336 lbs
Lateral displacement of wall top at Peak -load: -1.71 in.

Average peak load: 8048 lbs
Average lateral displacement: 1.52 in.

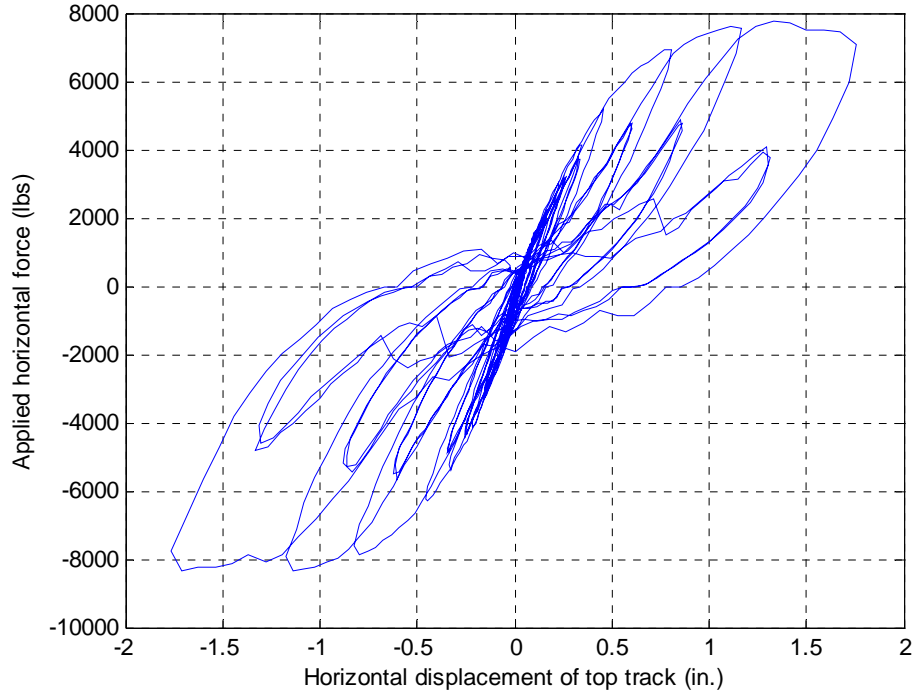

Observed Failure Mode: steel sheet buckled, screws pulled out at the mid height of one interior stud.

Screw Pull Out:

Z14;AW36;AV38;AE26;Y26;S26

Sheathing Tear: None

Screw Pull Over: None

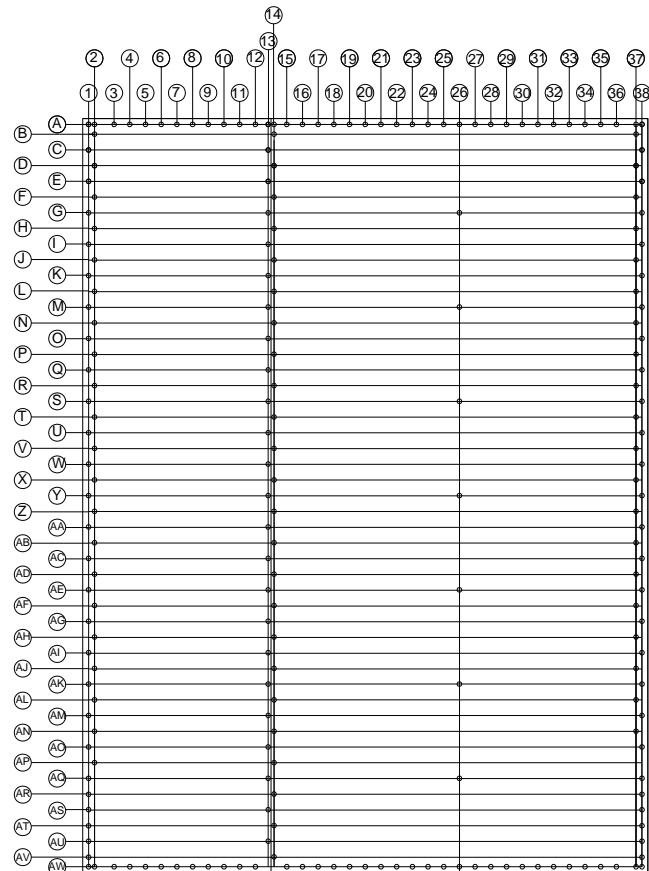



Test Label 8x6x350-43x30-2-C2-C

Test Date March 19, 2009

Specimen Configuration

Wall dimensions: 8 ft. x 6 ft. Studs: 350S162-43 Tracks: 350T150-43 Steel sheathing: 0.030 in. 33 ksi;
 Blocking: 350T150-43 Strapping: 33ksi 1 1/2" x 33mil
 Fastener: #10x3/4" modified truss head self-drilling screw, 2 in.o.c. (stagger) on the perimeter; Hold-down: Simpson Strong Tie S/HD10

Test protocol: Cyclic-CUREE

Test results

Peak +load: 8037 lbs
 Lateral displacement of wall top at
 Peak +load: 1.75 in.

Peak -load: -8428 lbs
 Lateral displacement of wall top at
 Peak -load: -1.1 in.

Average peak load: 8233 lbs
 Average lateral displacement: 1.42 in.

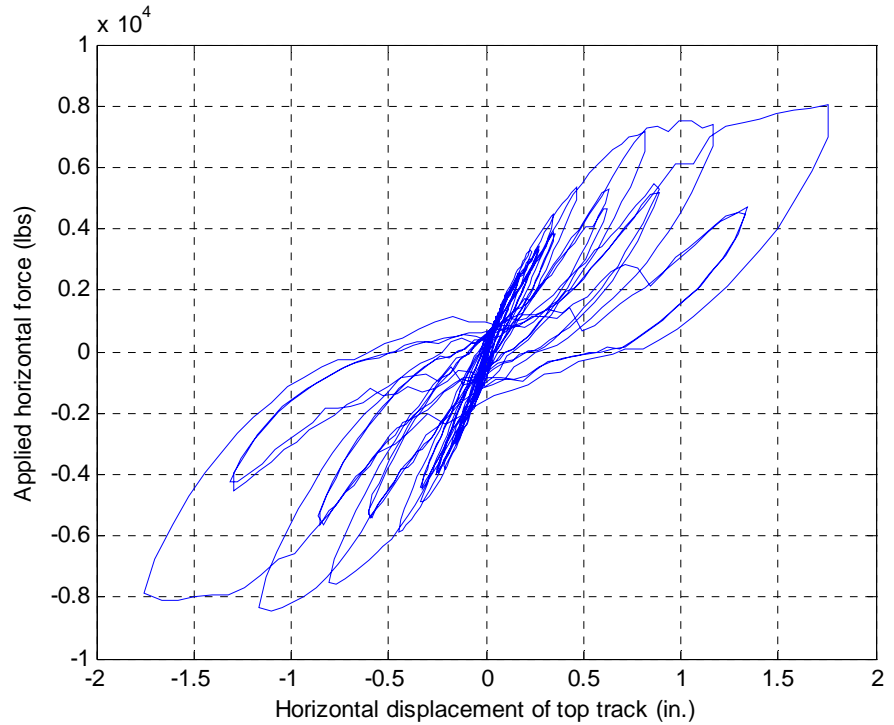

Observed Failure Mode: steel sheet buckled, screws pulled out at the mid height of one interior stud.

Screw Pull Out:

AV14; AT14; AR14; G26; Y26; S26; M26; AQ26; AK26; AE26

Sheathing Tear: None

Screw Pull Over: None

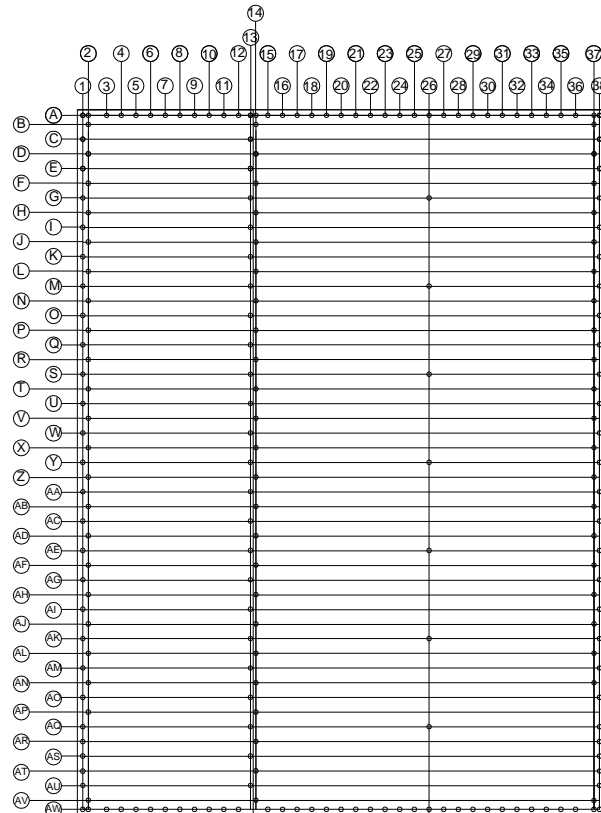



Test Label 8x6x600-43x33-2-M1-C

Test Date March 20, 2009

Specimen Configuration

Wall dimensions: 8 ft. x 6 ft. Studs: 600S162-43 Tracks: 600T125-43 Steel sheathing: 0.033 in. 33 ksi;
Blocking: 600T125-43 Strapping: 33ksi 1 1/2" x 33mil
Fastener: #10x3/4" modified truss head self-drilling screw, 2 in.o.c. (stagger) on the perimeter; Hold-down: Simpson Strong Tie S/HD10

Test protocol: Monotonic-ASTM E564

Test results

Peak load: 8122 lbs
Lateral displacement of wall top at peak load: 1.72 in.

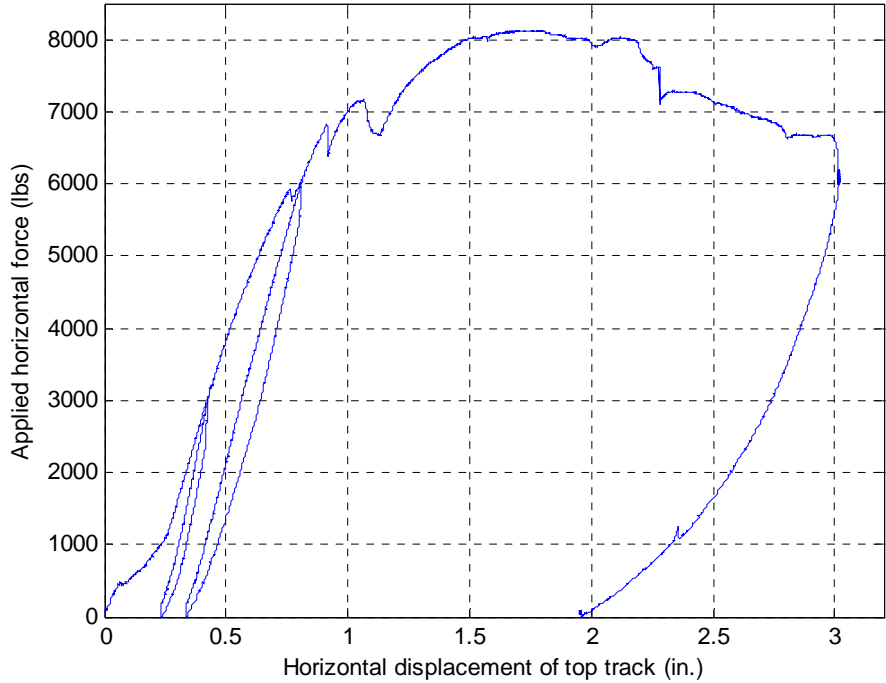

Observed Failure Mode: Steel sheet buckled, screw pulled out at center of interior studs, bottom track damaged by pulling of the sheets.

Screw Pull Out: AW36;AW37;AQ26;AK26

Sheathing Tear: None

Screw Pull Over: None

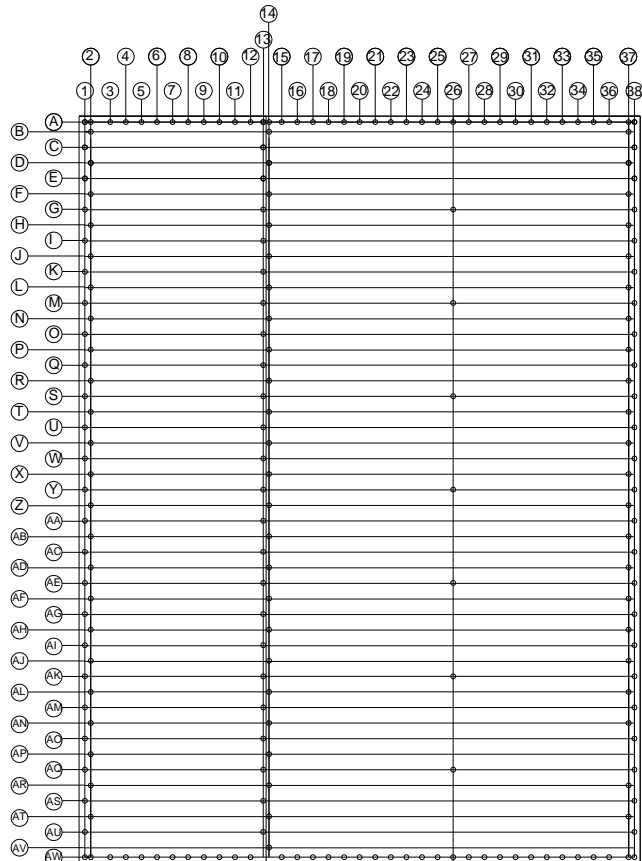



Test Label 8x6x600-43x33-2-C1-C

Test Date March 20, 2009

Specimen Configuration

Wall dimensions: 8 ft. x 6 ft. Studs: 600S162-43 Tracks: 600T125-43 Steel sheathing: 0.033 in. 33 ksi;
Blocking: 600T125-43 Strapping: 33ksi 1 1/2" x 33mil
Fastener: #10x3/4" modified truss head self-drilling screw, 2 in.o.c. (stagger) on the perimeter; Hold-down: Simpson Strong Tie S/HD10

Test protocol: Cyclic-CUREE

Test results

Peak +load: 9082 lbs
Lateral displacement of wall top at
Peak +load: 1.58 in.

Peak -load: -8883 lbs
Lateral displacement of wall top at
Peak -load: -1.60 in.

Average peak load: 8983 lbs
Average lateral displacement: 1.59 in.

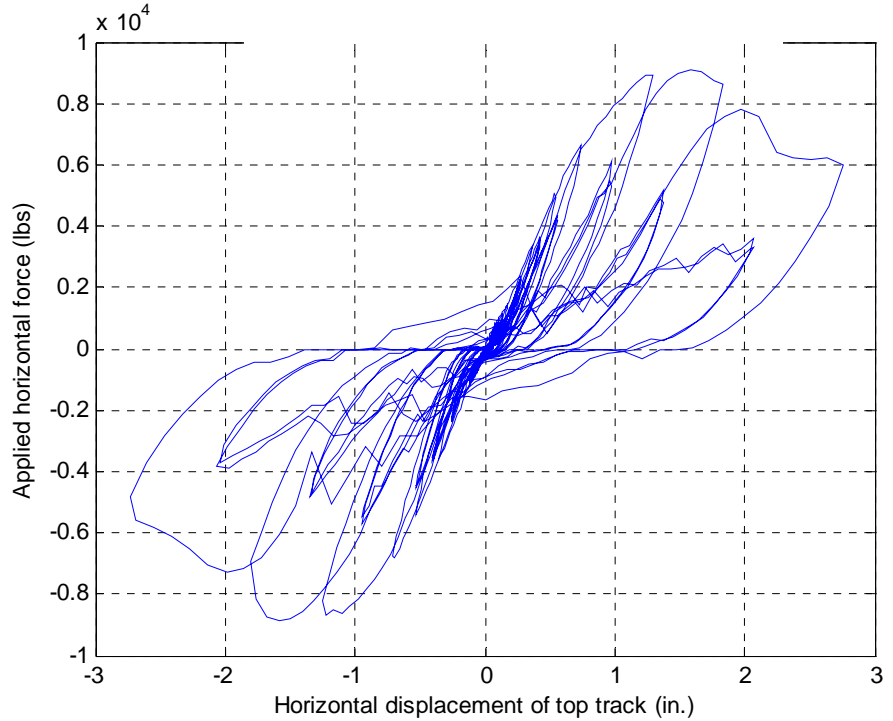

Observed Failure Mode: steel sheet buckled, screws pulled out, interior stud buckled.

Screw Pull Out:

AW3;AW36;AO26;AK26;AE26;Y26;S26;M26;
G26;AV14;AT14;AR14;AP14;AN14;AL14;B14;
D14;AP37;AR37;AT37;AV37;A37;A36;AS38;
B37;D37;F37;C38

Sheathing Tear: AW13

Screw Pull Over: None

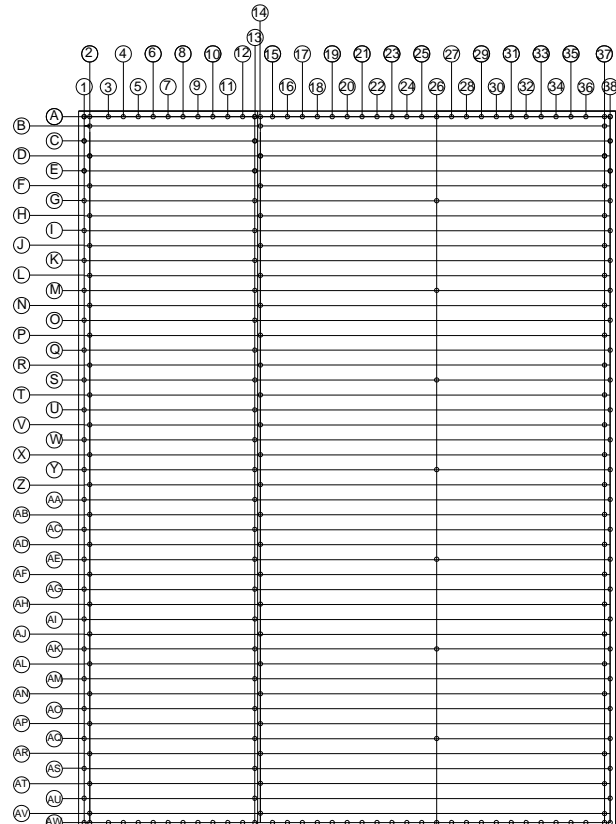



Test Label 8x6x600-43x33-2-C2-C

Test Date March 20, 2009

Specimen Configuration

Wall dimensions: 8 ft. x 6 ft. Studs: 600S162-43 Tracks: 600T125-43 Steel sheathing: 0.033 in. 33 ksi;
 Blocking: 600T125-43 Strapping: 33ksi 1 1/2" x 33mil
 Fastener: #10x3/4" modified truss head self-drilling screw, 2 in.o.c. (stagger) on the perimeter; Hold-down: Simpson Strong Tie S/HD10

Test protocol: Cyclic-CUREE

Test results

Peak +load: 8991 lbs
 Lateral displacement of wall top at Peak +load: 1.01 in.

Peak -load: -8733 lbs
 Lateral displacement of wall top at Peak -load: -1.00 in.

Average peak load: 8862 lbs
 Average lateral displacement: 1.01 in.

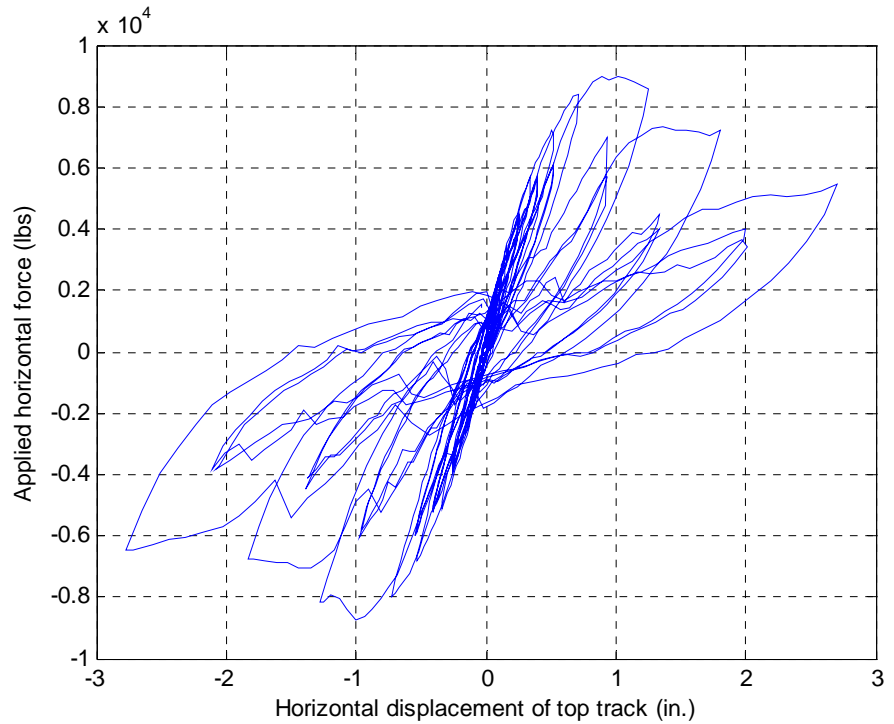

Observed Failure Mode: steel sheet buckled, screws pulled out at interior stud center and at panel corners, one interior stud distorted.

Screw Pull Out:

AW26;AQ26;AK26;AE26;Y26;S26;AO13;AQ13;

AP14;AR14;AT14;AV14;AW3;AW4;AW16;AE15

AW36;AW35;AS38;AU38;AP37;AR37;AT37;AV37

Sheathing Tear: None

Screw Pull Over: AW38

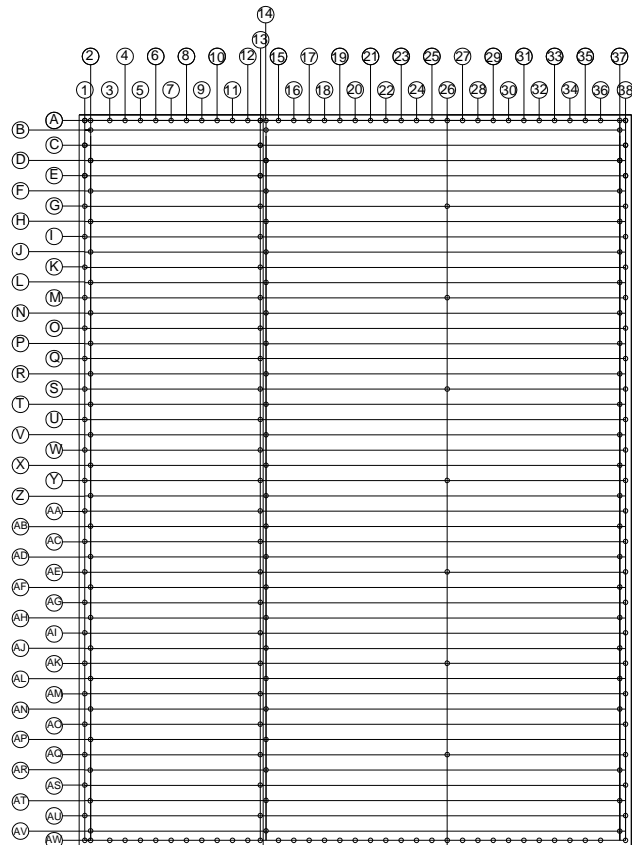

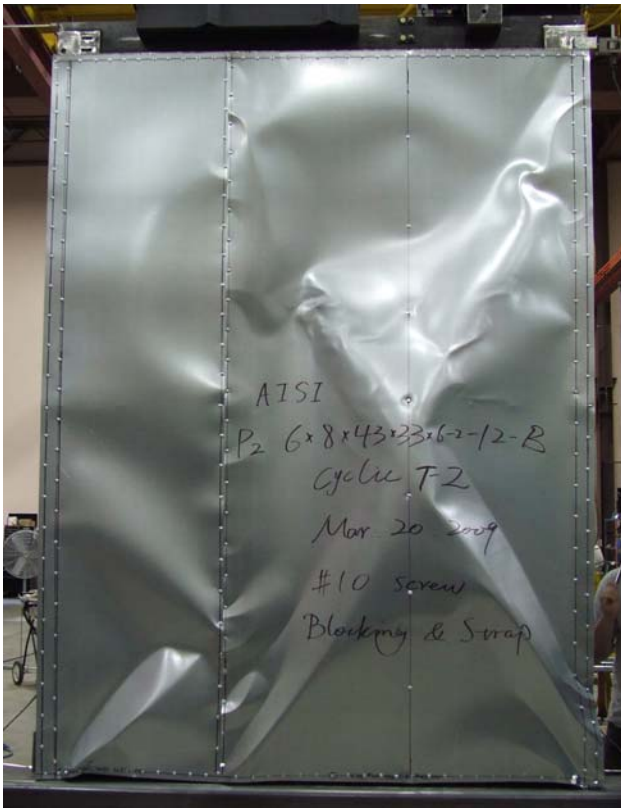

Test Label 8x6x350-54x33-2-M1-B

Test Date Apr 16, 2009

Specimen Configuration

Wall dimensions: 8 ft. x 6 ft. Studs: 350T162-54 Tracks: 350T162-54 Steel sheathing: 0.033 in. thick 33 ksi
 Fastener: #8-18x1/2in. modified truss head self-drilling screw, 2 in.o.c. on the perimeter; Hold-down: Simpson Strong Tie S/HD10

Test protocol: Monotonic-ASTM E564

Test results

Peak load: 10187 lbs
 Lateral displacement of wall top at peak load: 1.87 in.

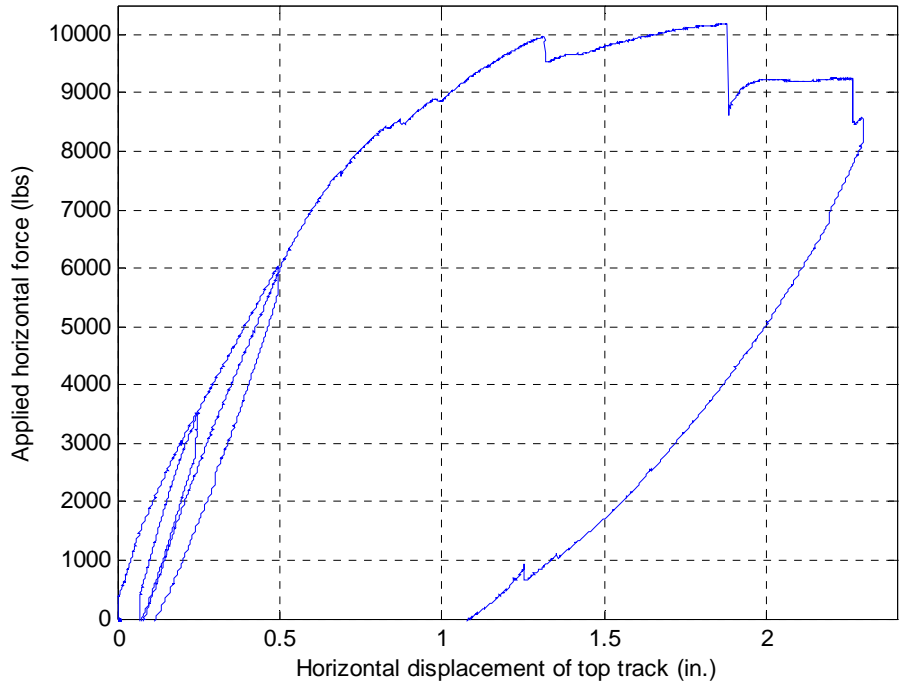

Observed Failure Mode: Steel sheet buckled, screw pulled out at center of filed studs, flange of chord studs distorted at bottom corner.

Screw Pull Out: AU38;AV38;AW37;AE26

Sheathing Tear: None

Screw Pull Over: AW38;AW36

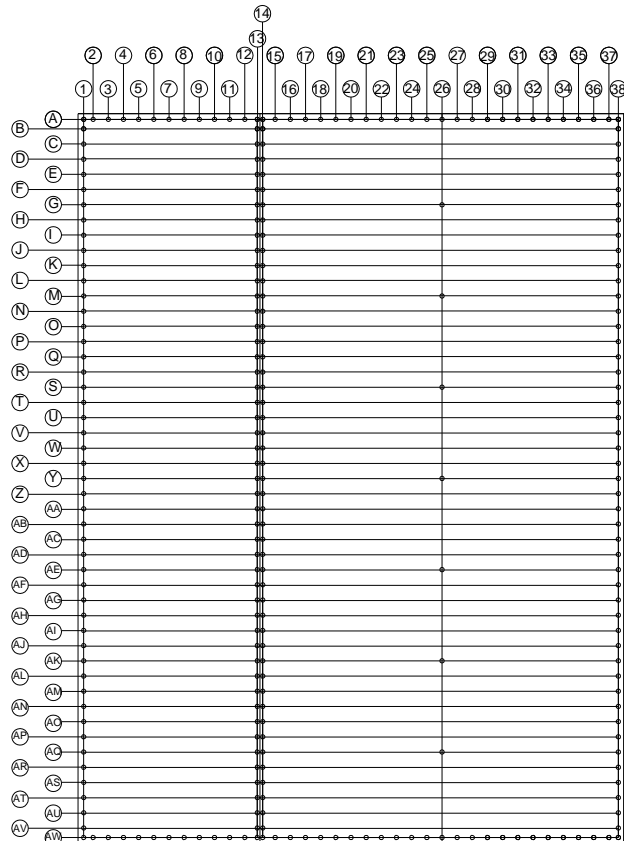



Test Label 8x6x350-54x33-2-C1-B

Test Date April 17, 2009

Specimen Configuration

Wall dimensions: 8 ft. x 6 ft. Studs: Studs: 350T162-54 Tracks: 350T162-54 Steel sheathing: 0.033 in. 33 ksi
 Fastener: #8-18x1/2in. modified truss head self-drilling screw, 2 in.o.c. on the perimeter; Hold-down: Simpson Strong Tie S/HD10

Test protocol: Cyclic-CUREE

Test results

Peak +load: 10386 lbs
 Lateral displacement of wall top at Peak +load: 1.32 in.

Peak -load: -11750 lbs
 Lateral displacement of wall top at Peak -load: -1.96 in.

Average peak load: 11068 lbs
 Average lateral displacement: 1.64 in.

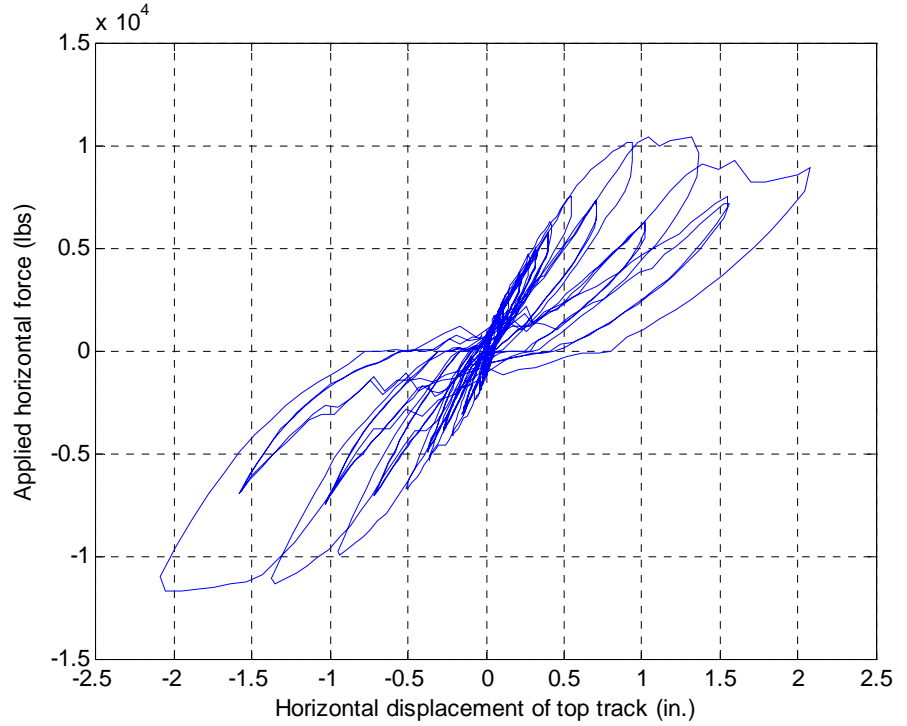

Observed Failure Mode: steel sheet buckled, screws pulled out at the mid-height of field stud. Flange of chord studs distorted at bottom.

Screw Pull Out: AW2;AE26;Y26;AW36

Sheathing Tear: AW38

Screw Pull Over:

AW37;AW35;AV38;AU38;AS38;AT38

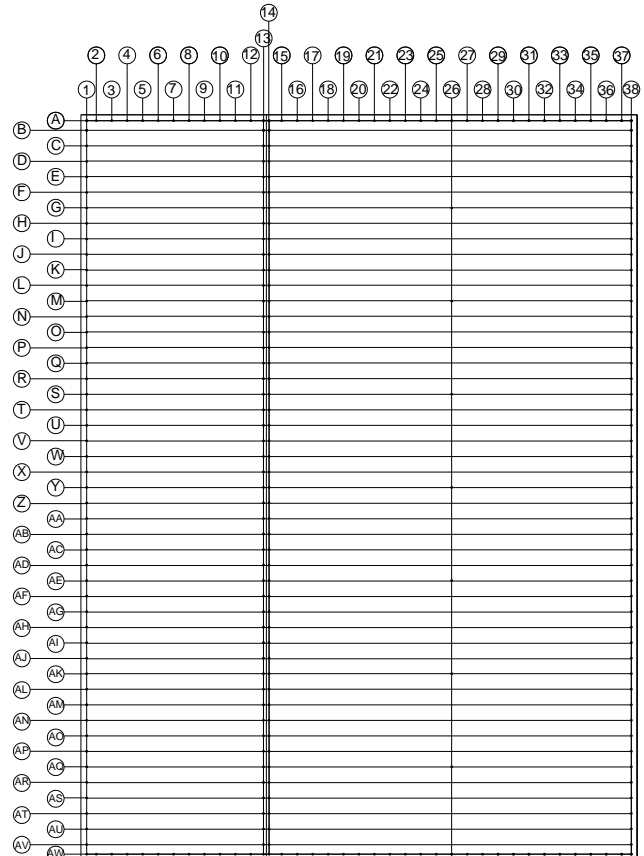



Test Label 8x6x350-54x33-2-C2-B

Test Date April 20, 2009

Specimen Configuration

Wall dimensions: 8 ft. x 6 ft. Studs: Studs: 350T162-54 Tracks: 350T162-54 Steel sheathing: 0.033 in. 33 ksi
 Fastener: #8-18x1/2in. modified truss head self-drilling screw, 2 in.o.c. on the perimeter; Hold-down: Simpson Strong Tie S/HD10

Test protocol: Cyclic-CUREE

Test results

Peak +load: 10806 lbs
 Lateral displacement of wall top at Peak +load: 1.31 in.

Peak -load: -11964 lbs
 Lateral displacement of wall top at Peak -load: -1.37 in.

Average peak load: 11385 lbs
 Average lateral displacement: 1.34in.

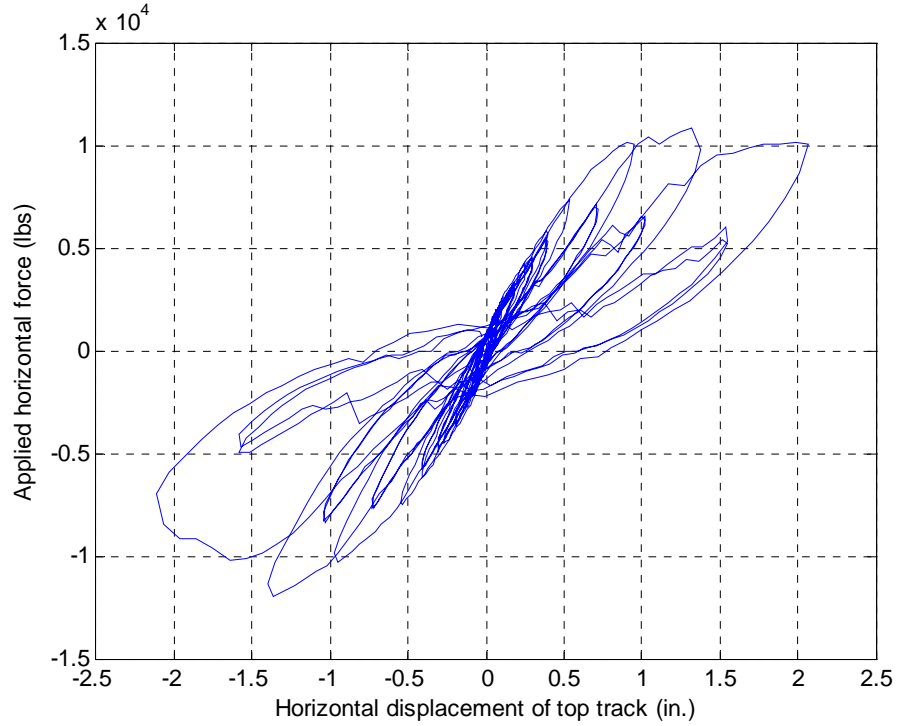

Observed Failure Mode: steel sheet buckled, screws pulled out at the mid-height of field stud, one interior stud is buckled.

Screw Pull Out:

AW35;AT38;AV38;B38;C38;D38;A36;A34;AE26
 ;Y26;S26;M26;G26

Sheathing Tear: A38

Screw Pull Over:

A2;A37;A35;AW38;AW36;AU38;AW37

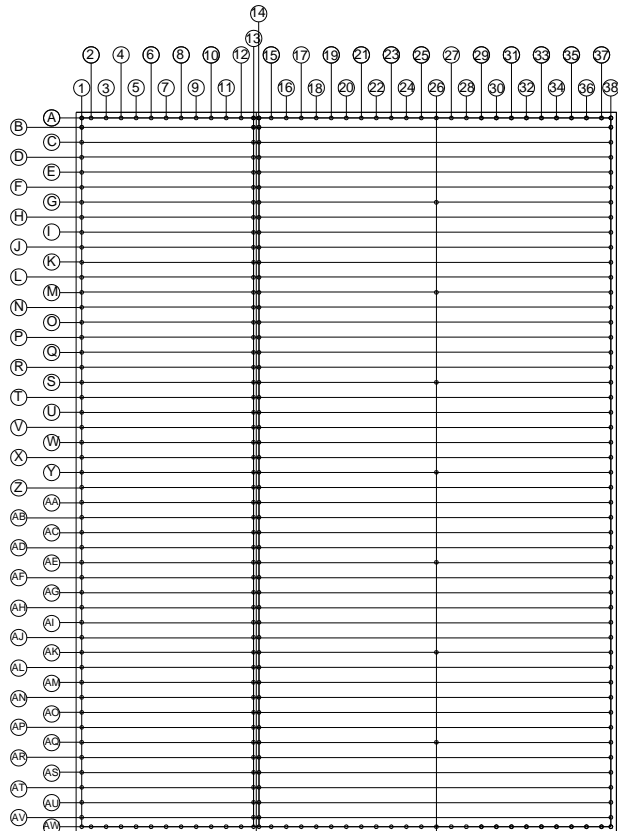



Test Label 8x6x350-43x27-2-M1-D

Test Date Apr 21, 2009

Specimen Configuration

Wall dimensions: 8 ft. x 6 ft. Studs: 350S150-43 Tracks: 350T150-43 Steel sheathing: 0.027 in. 33 ksi
Fastener: #8-18x1/2in. modified truss head self-drilling screw, 2 in.o.c. on the perimeter; Hold-down: Simpson Strong Tie S/HD10

Test protocol: Monotonic-ASTM E564

Test results

Peak load: 8282 lbs
Lateral displacement of wall top at peak load: 1.36 in.

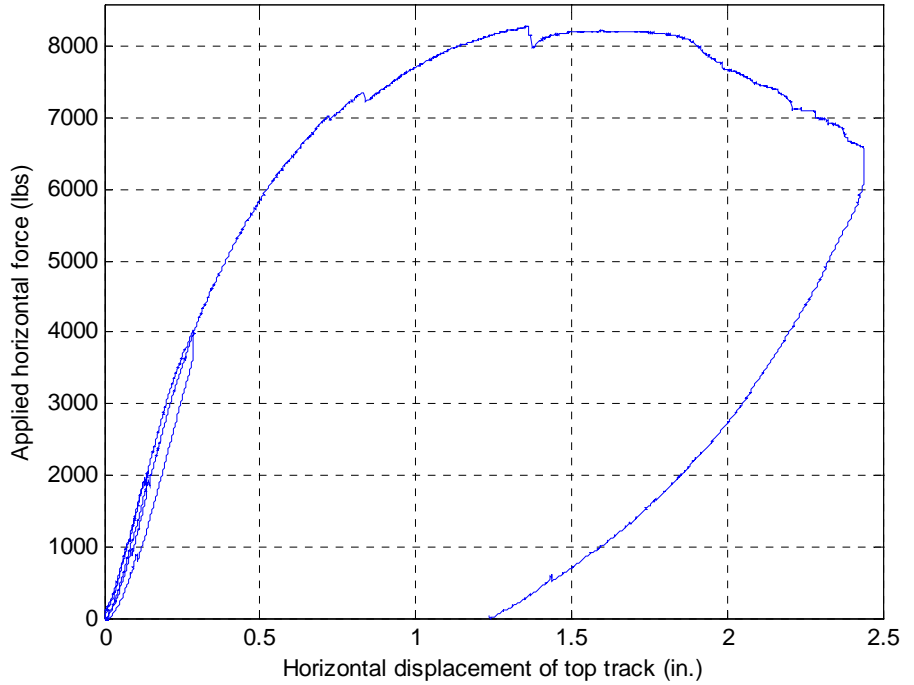

Observed Failure Mode: Steel sheet buckled, interior stud distorted, chord studs distorted on flanges at panel corners.

Screw Pull Out: A3;AW37

Sheathing Tear: None

Screw Pull Over: A2;AW39

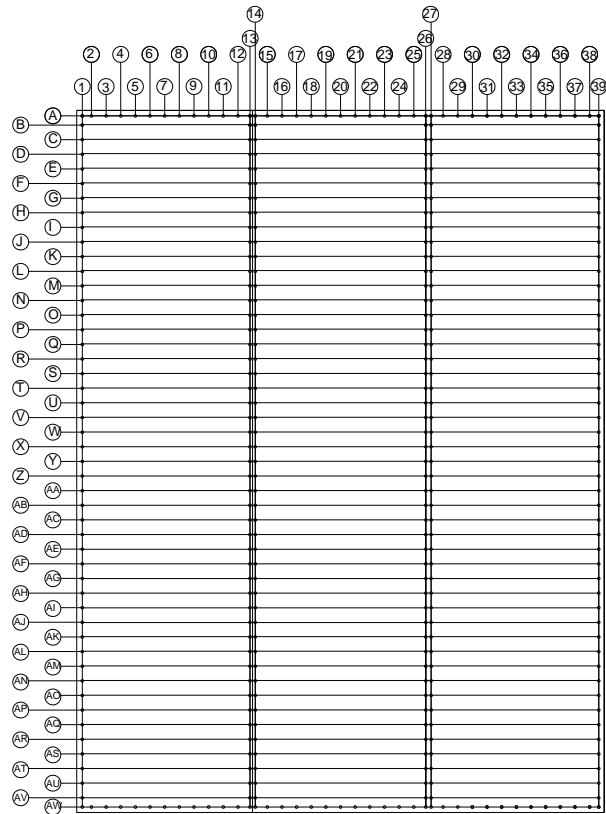



Test Label 8x6x350-43x27-2-C1-D

Test Date April 22, 2009

Specimen Configuration

Wall dimensions: 8 ft. x 6 ft. Studs: 350S150-43 Tracks: 350T150-43 Steel sheathing: 0.027 in. 33 ksi
 Fastener: #8-18x1/2in. modified truss head self-drilling screw, 2 in.o.c. on the perimeter; Hold-down: Simpson Strong Tie S/HD10

Test protocol: Cyclic-CUREE

Test results

Peak +load: 8954 lbs
 Lateral displacement of wall top at Peak +load: 1.41 in.

Peak -load: -8637lbs
 Lateral displacement of wall top at Peak -load: -1.43 in.

Average peak load: 8796lbs
 Average lateral displacement: 1.42 in.

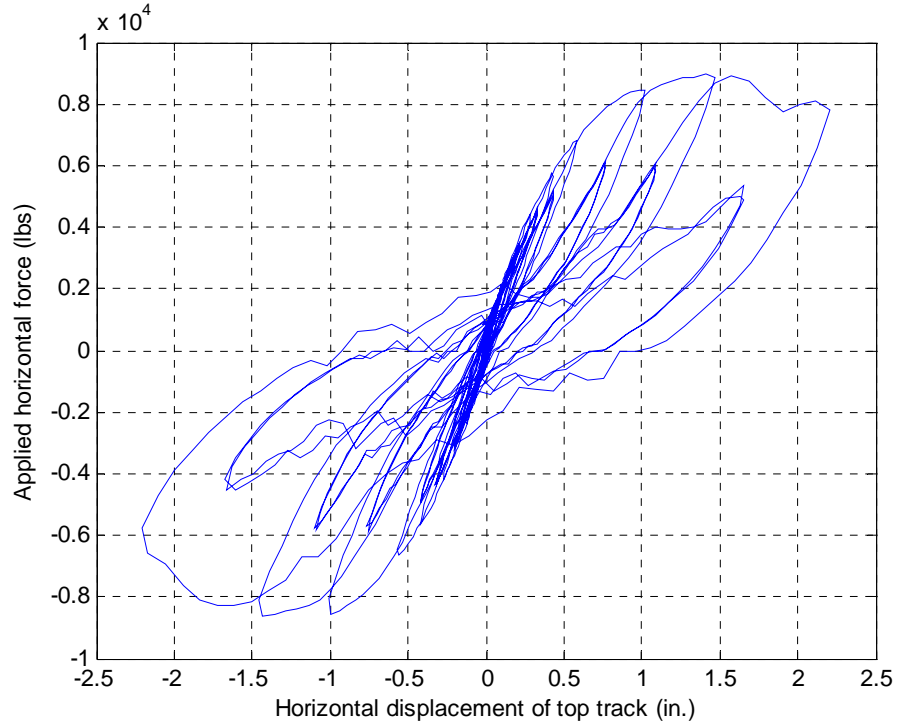

Observed Failure Mode: steel sheet buckled, one interior stud buckled.

Screw Pull Out:

AW37; AW2; AW3; AT1; AU1; AV1

Sheathing Tear: AW1;

Screw Pull Over: None

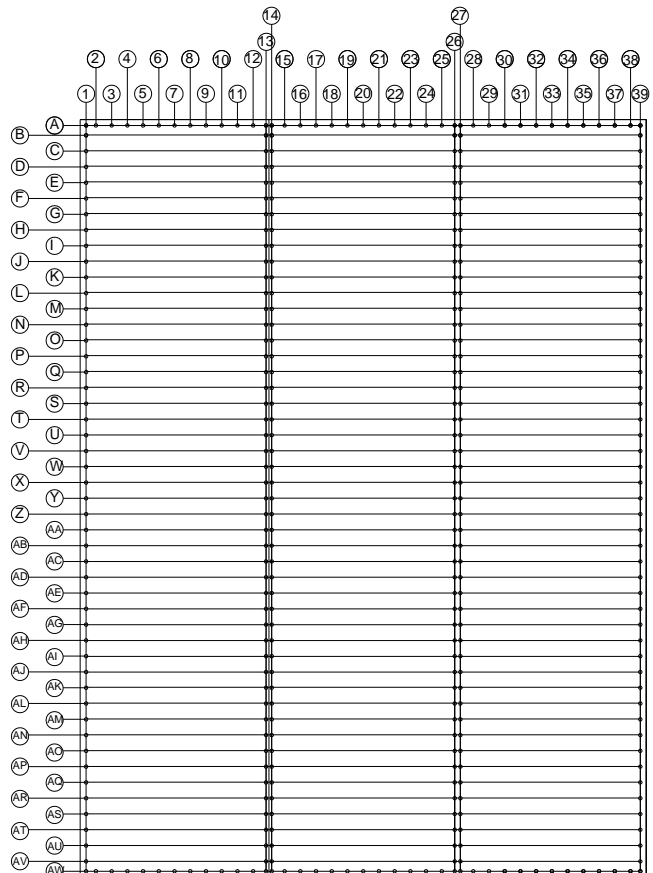



Test Label 8x6x350-54x33-2-M1-C

Test Date Apr 24, 2009

Specimen Configuration

Wall dimensions: 8 ft. x 6 ft. Studs: 350S162-54 Tracks: 350T150-54 Steel sheathing: 0.033 in. 33 ksi
 Blocking: 350T150-54 Strapping: 33ksi 1 1/2" x 33mil
 Fastener: #10x3/4" in. modified truss head self-drilling screw, 2 in.o.c. on the perimeter; Hold-down: Simpson Strong Tie S/HD10

Test protocol: Monotonic-ASTM E564

Test results

Peak load: 11932 lbs
 Lateral displacement of wall top at peak load: 2.49in.

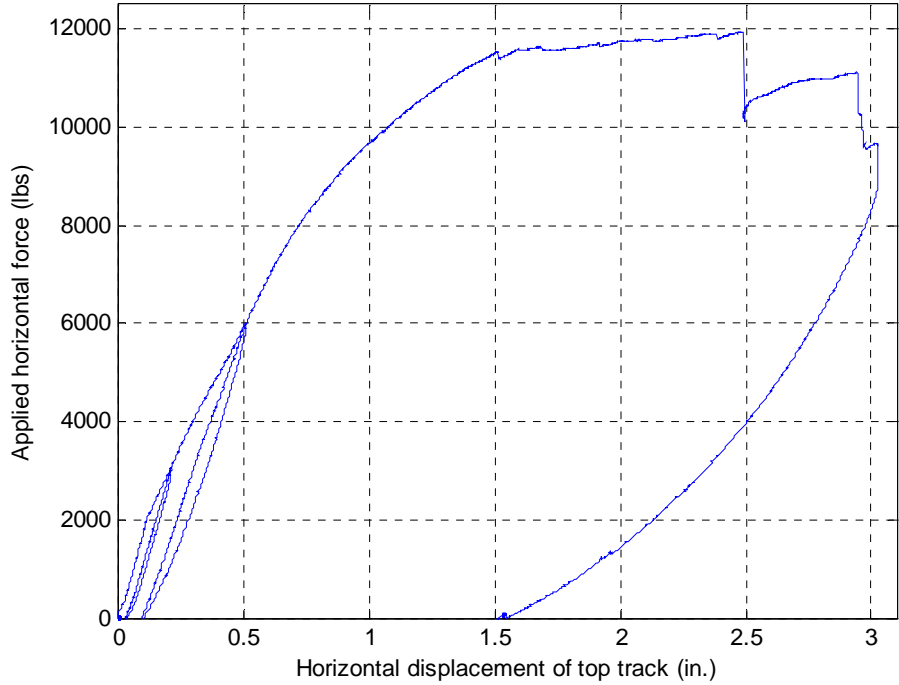

Observed Failure Mode: Steel sheet buckled, screws pulled out at the mid hight of the interior stud, the interior stud and bottom of the tension stud buckled.

Screw Pull Out: AW36;AW35;S26;M26;AU38

Sheathing Tear: AW37;AV38

Screw Pull Over: None

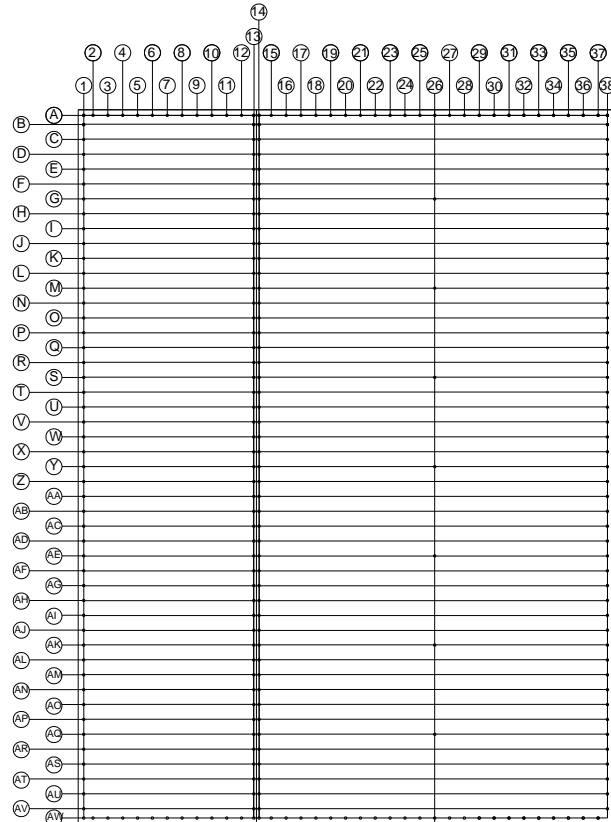



Test Label 8x6x350-54x33-2-C1-C

Test Date Apr 29, 2009

Specimen Configuration

Wall dimensions: 8 ft. x 6 ft. Studs: 350S162-54 Tracks: 350T150-54 Steel sheathing: 0.033 in. 33 ksi;
Blocking: 350T150-54 Strapping: 33ksi 1 1/2" x 33mil
Fastener: #10x3/4" in. modified truss head self-drilling screw, 2 in.o.c. on the perimeter; Hold-down: Simpson Strong Tie S/HD10

Test protocol: Cyclic-CUREE

Test results

Peak +load: 12005lbs
Lateral displacement of wall top at Peak +load: 1.68 in.

Peak -load: -11921lbs
Lateral displacement of wall top at Peak -load: -1.63 in.

Average peak load: 11963 lbs
Average lateral displacement: 1.65 in.

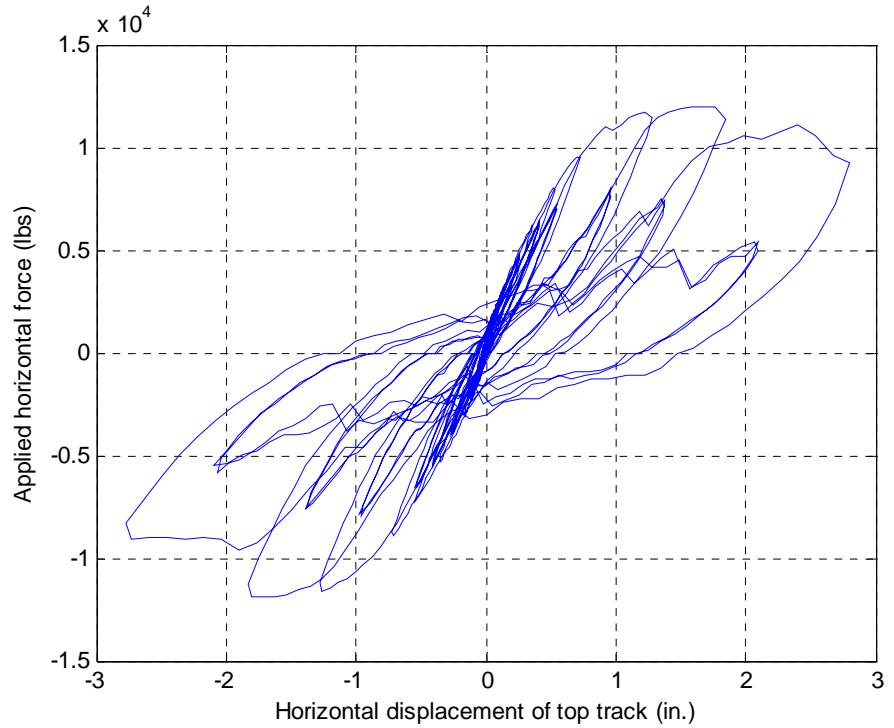

Observed Failure Mode: steel sheet buckled, screws pulled out at the bottom of joint stud and mid-height of field stud.

Screw Pull Out: AK26;AE26;S26;M26;AW35;B38

Sheathing Tear: AW36;AW38;A38

Screw Pull Over: AW37;A37;A36

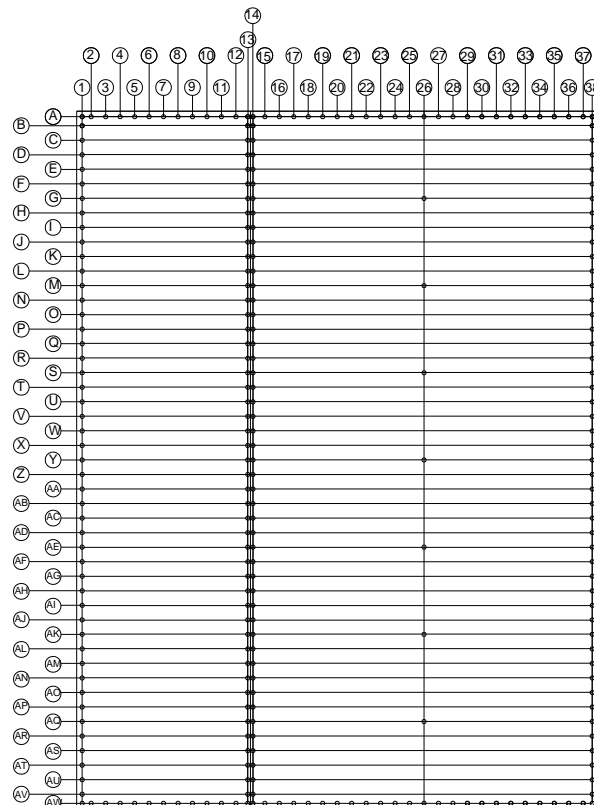



Test Label 8x6x350-54x33-2-C2-C

Test Date Apr 30, 2009

Specimen Configuration

Wall dimensions: 8 ft. x 6 ft. Studs: 350S162-54 Tracks: 350T150-54 Steel sheathing: 0.033 in. 33 ksi;
Blocking: 350T150-54 Strapping: 33ksi 1 1/2" x 33mil
Fastener: #10x3/4" in. . modified truss head self-drilling screw, 2 in.o.c. on the perimeter; Hold-down: Simpson Strong Tie S/HD10

Test protocol: Cyclic-CUREE

Test results

Peak +load: 12860lbs
Lateral displacement of wall top at Peak +load: 1.46 in.

Peak -load: -13235lbs
Lateral displacement of wall top at Peak -load: -1.66 in.

Average peak load: 13048 lbs
Average lateral displacement: 1.56 in.

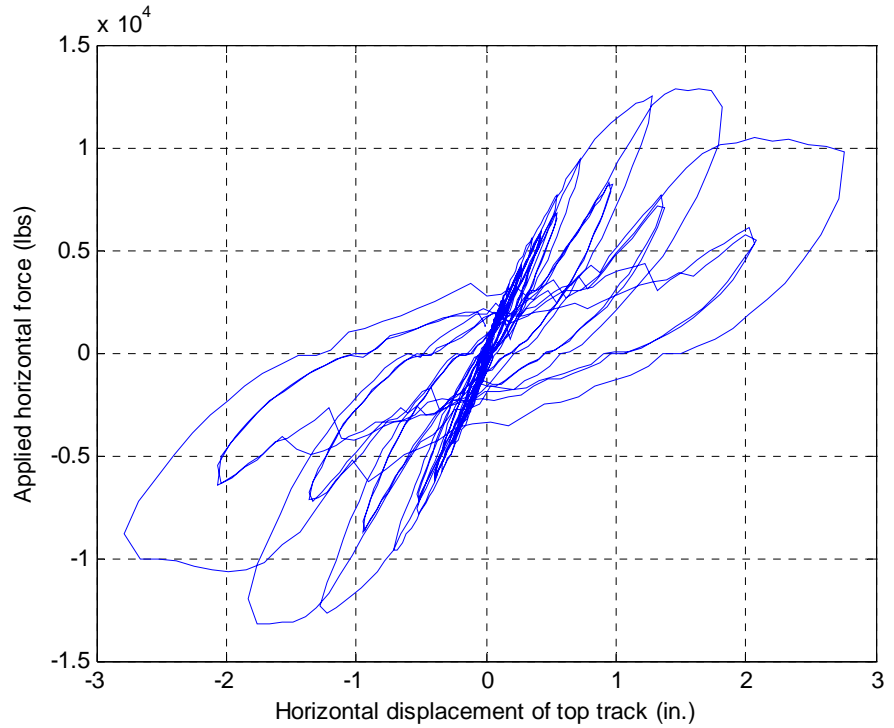

Observed Failure Mode: steel sheet buckled, screws pulled out at the mid height of the field stud.

Screw Pull Out:

AE26;Y26;S26;M26;G26;AW37;C1;A2;B2;A1;

A4;A38;B37;D37

Sheathing Tear: AW1

Screw Pull Over: A3

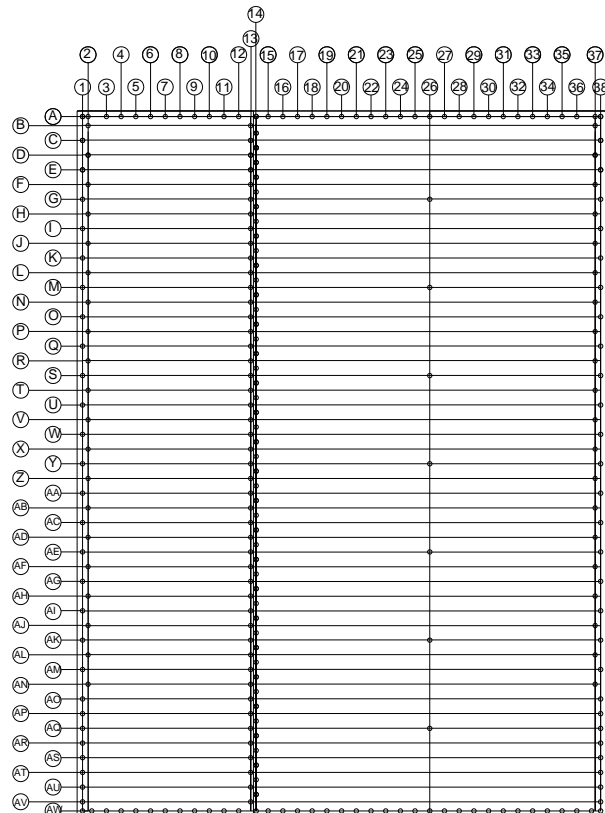



Test Label 8x4x350-43x33-2-C1-C

Test Date May 07, 2009

Specimen Configuration

Wall dimensions: 8 ft. x 4 ft. Studs: 350S162-43 Tracks: 350T150-43 Steel sheathing: 0.033 in. 33 ksi
Blocking: 350T150-43 Strapping: 33ksi 1 1/2" x 33mil
Fastener: #10x3/4" in. . modified truss head self-drilling screw, 2 in.o.c. on the perimeter; Hold-down: Simpson Strong Tie S/HD10

Test protocol: Cyclic-CUREE

Test results

Peak +load: 6421lbs
Lateral displacement of wall top at Peak +load: 1.17 in.

Peak -load: -5949lbs
Lateral displacement of wall top at Peak -load: -1.41 in.

Average peak load: 6185 lbs
Average lateral displacement: 1.29 in.

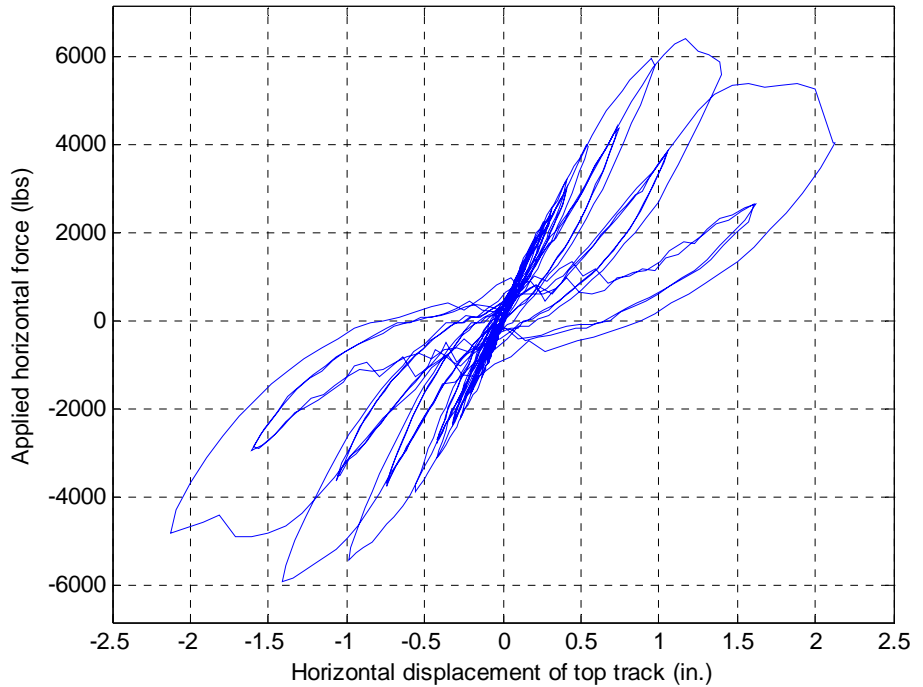

Observed Failure Mode: steel sheet buckled, screws pulled out at the mid-height of the field stud.

Screw Pull Out:

AK13;AE13;Y13;S13;AW2;AW23;AW24;AW25

AV25;A4;A38;B37;D37

Sheathing Tear: None

Screw Pull Over: None

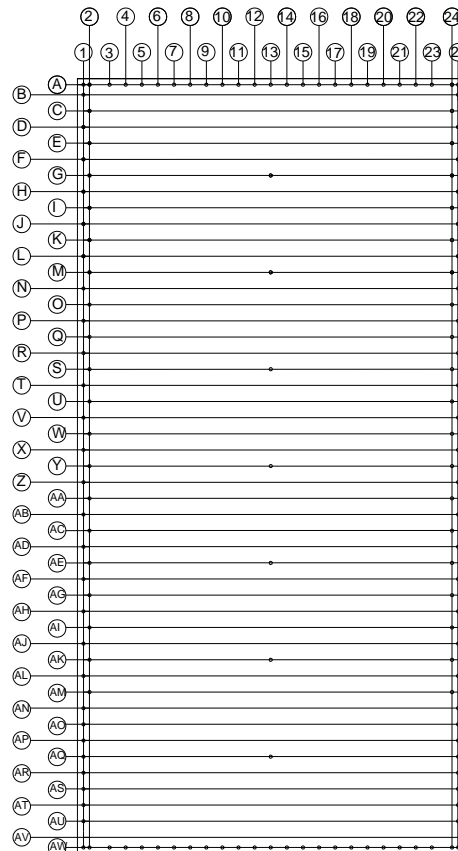



Test Label 8x4x350-43x33-2-C2-C

Test Date May 08, 2009

Specimen Configuration

Wall dimensions: 8 ft. x 4 ft. Studs: 350S162-43 Tracks: 350T150-43 Steel sheathing: 0.033 in. 33 ksi
Blocking: 350T150-43 Strapping: 33ksi 1 1/2" x 33mil
Fastener: #10x3/4" in. . modified truss head self-drilling screw, 2 in.o.c. on the perimeter; Hold-down: Simpson Strong Tie S/HD10

Test protocol: Cyclic-CUREE

Test results

Peak +load: 6462lbs
Lateral displacement of wall top at
Peak +load: 1.43 in.

Peak -load: -6125lbs
Lateral displacement of wall top at
Peak -load: -1.85 in.

Average peak load: 6294 lbs
Average lateral displacement: 1.64 in.

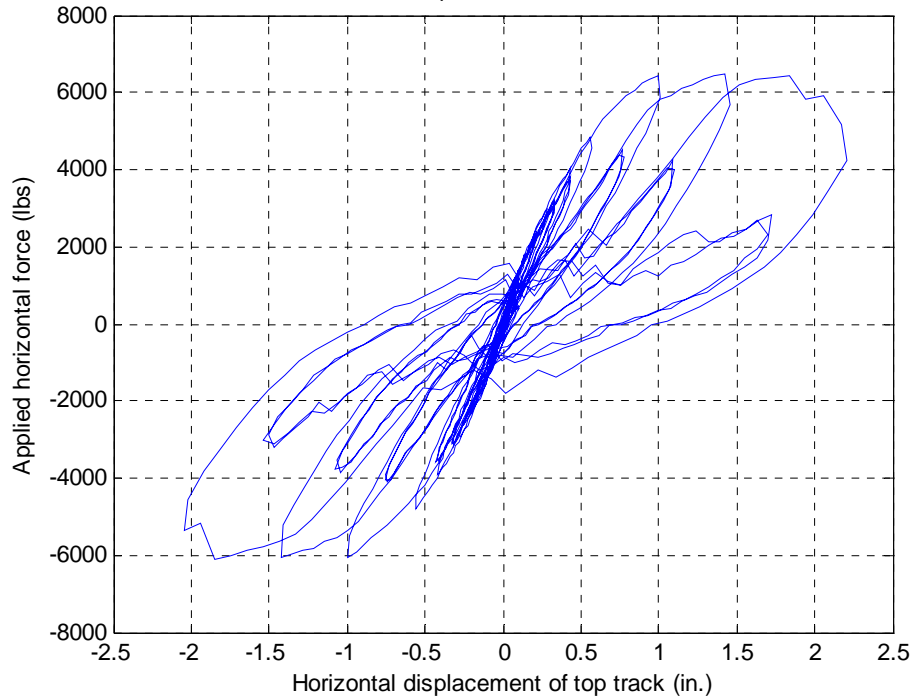

Observed Failure Mode: steel sheet buckled, screws pulled out at the mid-height of the field stud.

Screw Pull Out: M13;AE13;Y13;S13;A3;C2;B1

Sheathing Tear: None

Screw Pull Over: A1;A2

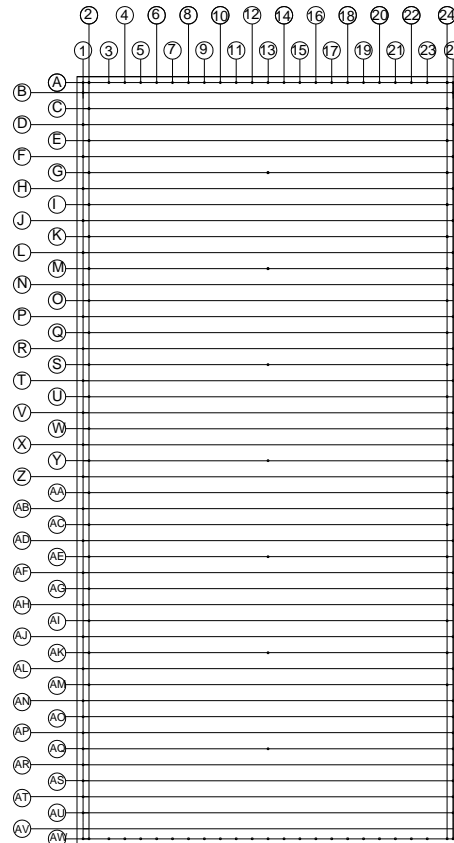



Test Label 8x2x350-43x33-2-C1-C

Test Date May 13, 2009

Specimen Configuration

Wall dimensions: 8 ft. x 2 ft. Studs: 350S162-43 Tracks: 350T150-43 Steel sheathing: 0.033 in. 33 ksi
Blocking: 350T150-43 Strapping: 33ksi 1 1/2" x 33mil
Fastener: #10x3/4" in. modified truss head self-drilling screw, 2 in.o.c. on the perimeter; Hold-down: Simpson Strong Tie S/HD10

Test protocol: Cyclic-CUREE

Test results

Peak +load: 3093lbs
Lateral displacement of wall top at Peak +load: 2.08 in.

Peak -load: -3334lbs
Lateral displacement of wall top at Peak -load: -2.31 in.

Average peak load: 3213 lbs
Average lateral displacement: 2.20 in.

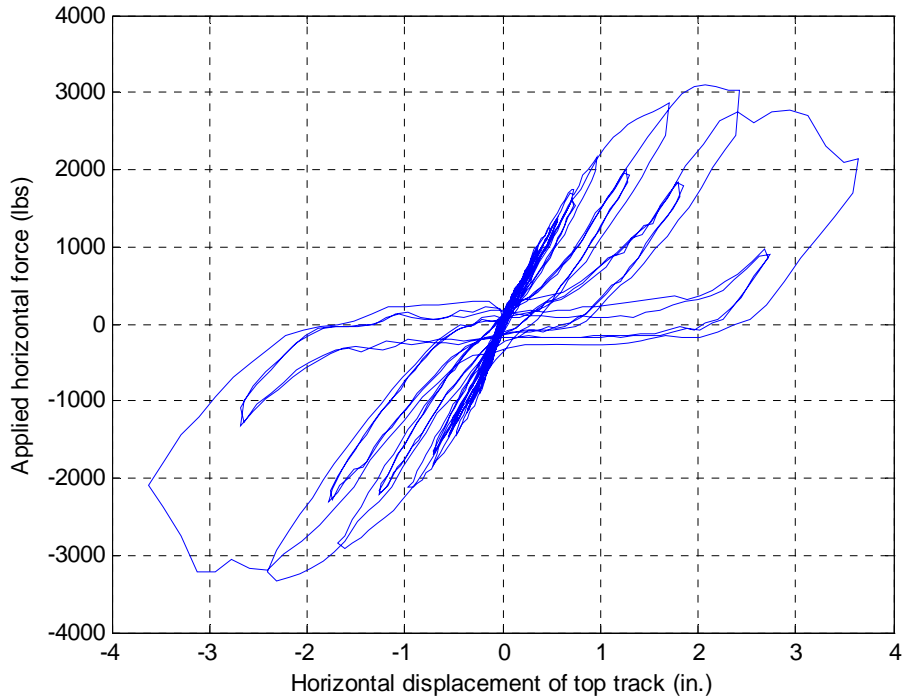

Observed Failure Mode: steel sheet buckled, both chord studs buckled at the bottom.

Screw Pull Out: None

Sheathing Tear: None

Screw Pull Over: None

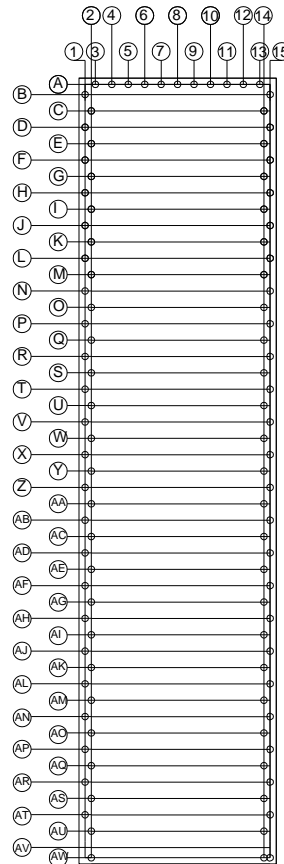

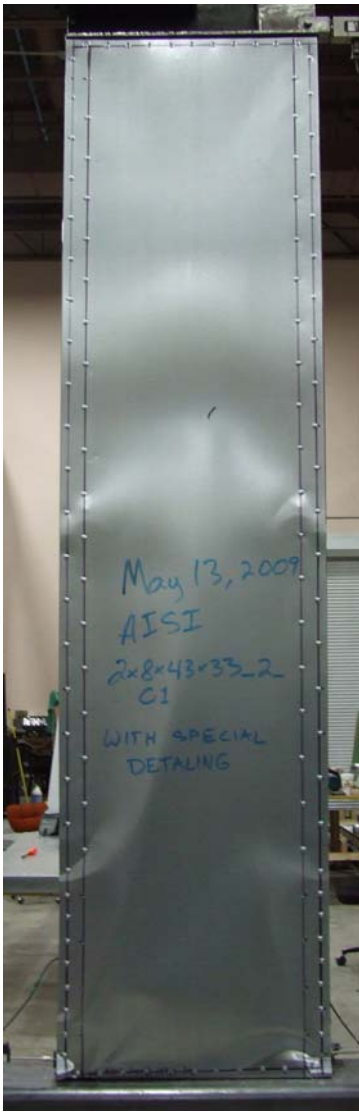

Test Label 8x2x350-43x33-2-C2-C

Test Date May 13, 2009

Specimen Configuration

Wall dimensions: 8 ft. x 2 ft. Studs: 350S162-43 Tracks: 350T150-43 Steel sheathing: 0.033 in. 33 ksi;
 Blocking: 350T150-43 Strapping: 33ksi 1 1/2" x 33mil
 Fastener: #10x3/4" in. . modified truss head self-drilling screw, 2 in.o.c. on the perimeter; Hold-down: Simpson Strong Tie S/HD10

Test protocol: Cyclic-CUREE

Test results

Peak +load: 3310lbs
 Lateral displacement of wall top at Peak +load: 2.21 in.

Peak -load: -3139lbs
 Lateral displacement of wall top at Peak -load: -2.43 in.

Average peak load: 3224 lbs
 Average lateral displacement: 2.32in.

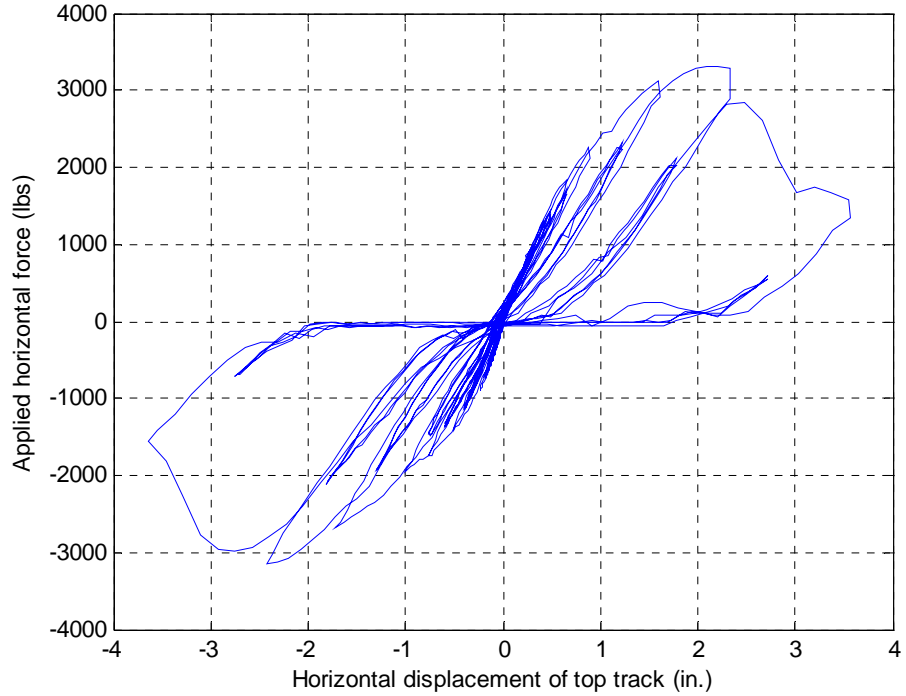

Observed Failure Mode: steel sheet buckled, both chord studs buckled at bottom.

Screw Pull Out: None

Sheathing Tear: None

Screw Pull Over: None

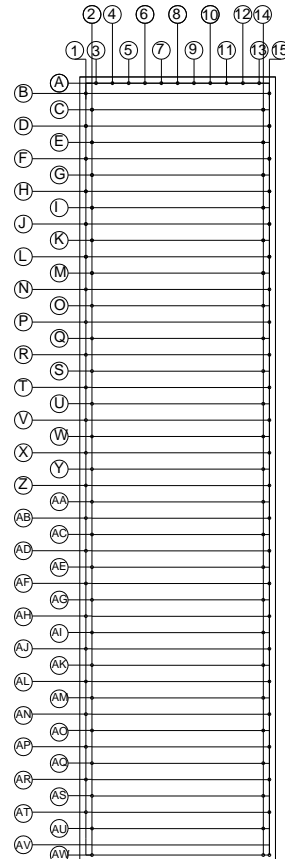





American Iron and Steel Institute

1140 Connecticut Avenue, NW
Suite 705
Washington, DC 20036
www.steel.org



Steel Framing Alliance™

Steel. The Better Builder.

1201 15th Street, NW
Suite 320
Washington, DC 20005
www.steel framing.org

