



## Missouri S&T Magazine Fall/Winter 2018

Missouri S&T Marketing and Communications Department

Miner Alumni Association

Follow this and additional works at: <https://scholarsmine.mst.edu/alumni-magazine>

---

### Recommended Citation

Missouri S&T Marketing and Communications Department and Miner Alumni Association, "Missouri S&T Magazine Fall/Winter 2018" (2018). *Missouri S&T Magazine*. 10.

<https://scholarsmine.mst.edu/alumni-magazine/10>

This Magazine is brought to you for free and open access by Scholars' Mine. It has been accepted for inclusion in Missouri S&T Magazine by an authorized administrator of Scholars' Mine. This work is protected by U. S. Copyright Law. Unauthorized use including reproduction for redistribution requires the permission of the copyright holder. For more information, please contact [scholarsmine@mst.edu](mailto:scholarsmine@mst.edu).



# MENTORS, LEADERS, GUIDES

A LOOK AT THE NEW FACES OF  
LEARNING AT MISSOURI S&T.

MAKING TORNADO  
ALLEY SAFER 4

HOW MANY BLASTS  
CAN A MINE SEAL TAKE? 18



Wishing you the

# BEST-EVER holiday season

A lot has changed since the first St. Pat's celebration in 1908, but the patron saint of engineers remains a steadfast symbol of tradition, pride and revelry by more than 60,000 Miner alumni.

As you consider your year-end giving decisions, we hope you'll remember the Miner Alumni Association. Your tax-deductible gift will make a difference — and make memories — for Miners today, tomorrow and for generations to come.

[mineralumni.com/give](http://mineralumni.com/give)



→ and a little  
Miner mischief.

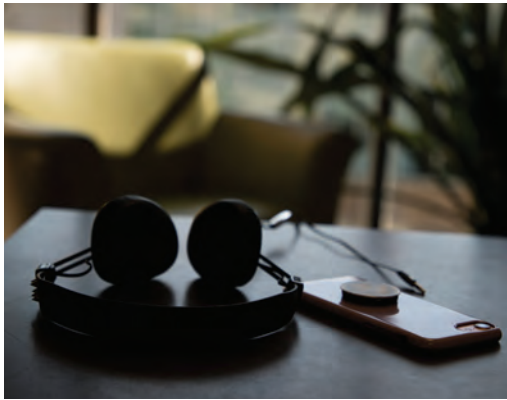

## CORRECTION

The obituary of **Joseph Davis**, MS CE'69, that ran in the Summer 2018 issue of the magazine incorrectly included a photo of **Jimmy L. Davis**, ME'70, who is not deceased. We apologize for the error. **Joseph Davis'** correct obituary appears on page 47.

## AROUND THE PUCK

- 4 Making tornado alley safer**  
Grace Yan uses small-scale tornado simulators to mimic a twister.
- 6 An eye for business**  
Tim Schreffl hopes to use his education and love of sports to land a job with a major sports brand.
- 10 To improve nuclear energy, look inside the fuel pins**  
Joseph Graham uses gamma radiation to see through spent nuclear fuel.
- 13 50 years of teaching excellence**  
Gerald Cohen and Gary Long joined the S&T faculty in 1968 and are still educating Miners.
- 14 Homecoming: Minerfest 2018**  
Check out a few of the scenes from S&T's 2018 Homecoming celebration.
- 18 How many blasts can a mine seal take?**  
Kyle Perry is building a giant cannon to blast debris at concrete mine seals.
- 21 Inspired to scholarship**  
Four faculty members influenced Nicholas Villanueva, Hist'06, to pursue an academic career.

## FEATURES

- 22 Mentors, leaders, guides**  
These new S&T faculty are productive and passionate about teaching. See how they've made a home at S&T.

## BEYOND THE PUCK

- 36 Come together**  
Catch a glimpse of alumni events at sections across the country.
- 37 Class notes**  
Find out what your former classmates are up to.
- 41 Rock-and-roll grandpa earns Ph.D.**  
Mike Lusher, CE'96, MS CE'04, PhD CE'18, goes from Def Leppard roadie to civil engineer.
- 45 Memorials**  
We remember our classmates and friends.
- 48 Keeping civil in the family**  
Steve, CE'87, MS EMgt'94; Tom, CE'88; and Bob, CE'63, Sieckhaus.



# 8,607

Students enrolled for the fall semester at Missouri S&T. Classes started Aug. 20.

# 3

Missouri S&T's ranking among engineering programs nationwide, according to College Factual. This is the fifth consecutive year S&T has achieved a No. 3 ranking.

# 91

Percentage of first-year freshmen who receive scholarships and financial aid.

## MISSOURI S&T BY THE NUMBERS



# \$530,000

Royalty income Missouri S&T received from patents on commercialized inventions and products during last fiscal year.

# 19

Percentage of first-generation college students enrolled at Missouri S&T during the fall semester.

# 331

Employers recruiting at the Fall Career Fair, held on campus Sept. 25 — a new record.

# 1950

Last year the Miners appeared in a post-season bowl game before this season. The Miners played in the Mineral Water Bowl on Dec. 1, 2018.

# MISSOURI S&T MAGAZINE

Missouri S&T Magazine is written, edited and designed by the staff of the Missouri S&T Marketing and Communications Department and the Miner Alumni Association.

#### CHANCELLOR

Christopher G. Maples

#### VICE CHANCELLOR FOR UNIVERSITY ADVANCEMENT

Joan Nesbitt

#### MINER ALUMNI ASSOCIATION PRESIDENT

Stephen W. Rector, PetE'72, MS PetE'73

#### EDITORS

Nancy Hatch (Alumni)

Mary Helen Stoltz, EngI'95 (News & Features)

#### ASSOCIATE NEWS EDITORS

Maridel Allinder Andrew Careaga

Peter Ehrhard Sarah Potter

#### ASSOCIATE ALUMNI EDITORS

Logan Campbell

Melanie Keeney, Hist'06, MBA'12

#### DESIGN AND PRODUCTION

Jake Otto Lindsay Stanford Lishia Stevens

#### STAFF PHOTOGRAPHER

Sam O'Keefe

#### CONTRIBUTORS

Terry Barner Delia Croessmann

Mindy Limback Alan Scher Zagier

Missouri S&T Magazine (ISSN 1084-6948) is issued three times per year (April, August, December) in the interest of the graduates and former students of the Missouri School of Mines and Metallurgy, the University of Missouri-Rolla and Missouri University of Science and Technology. Missouri S&T Magazine is published by the Miner Alumni Association, Missouri S&T, 1100 N. Pine St., Rolla, MO 65409-0650.

Missouri S&T Magazine is printed by LSC Communications, Liberty, Mo. Covers are printed on 114 lb. — 7 pt. Sterling White; interior pages are printed on 60 lb. Sterling White.

Missouri S&T Magazine is printed using soy-based ink.

#### Send letters to:

Darlene Ramsay  
Miner Alumni Association  
1100 N. Pine St.  
Rolla, MO 65409-0650  
Phone: 800-JO-MINER  
Fax: 573-341-4706  
Email: [alumni@mst.edu](mailto:alumni@mst.edu)

#### News & features:

Phone: 573-341-4328  
Fax: 573-341-6157  
Email: [news@mst.edu](mailto:news@mst.edu)  
[magazine.mst.edu](mailto:magazine.mst.edu)

# Q&A

## BEST CLASS EVER

*What was your favorite class?*

*As part of his research for the S&T sesquicentennial history book, **Larry Gragg**, Curators' Distinguished Teaching Professor emeritus of history and political science, asked you to share memories of your favorite class. Here are a few of your answers.*

**“My favorite class was Advanced Structure Design.**

Never used it in my 31 years with MoDOT, but it still was very interesting and reinforced my previous training in bridge design as well as engineering statics. It was Missouri School of Mines and Metallurgy when I started and University of Missouri-Rolla when I graduated. It was a very good investment for me, and I had a great career thanks to the many professors who taught me the fundamentals. By the grace of God, I made it through the school and enjoyed a reasonably good lifestyle. I am now retired and enjoying this career. Go Miners!”

**Marvin D. Phillips**, CE'70  
Jefferson City, Mo.

**“Favorite class: Music Appreciation.”**

**Ken Bowles**, EE'66  
Union, Mo.

**“Any class that Dr. Al Spreng (professor emeritus of geology and geophysics) taught!**

He was a great teacher and mentor — as well as a friend later in life.”

**Gail Davidge Kettenbrink**, GGph'67  
Tipton, Iowa

**“My favorite class was Mineral Processing taught by Prof. (Ken) Clifford.**

This subject helped me to advance my career from a mining engineer to plant manager, chief mining engineer in charge of quarries in the USA, Mexico and Nova Scotia, Canada, as well as UAE, Turkey, Oman, West Africa, Bulgaria, Iran and more countries. Excellent class. I hope the school continues to offer these classes.”

**Bahram Shajary**, MinE'77  
Orange, Calif.

**“Digital computer lab as well as Control Systems I.”**

**David G. Sizemore**, EE'71  
San Diego

**“Definitely, my favorite class during my stay at UMR was Metallurgy Thermodynamics, taught by Dr. Fred Kisslinger (ChE'42).**

A really great experience and very useful knowledge in my professional life.”

**Juan F. Mojica**, MetE'74, MS Phys'74, PhD Phys'75  
Monterrey, N.L. Mexico

**“One of my favorites was the Witches and Witchcraft class with Dr. (Larry) Gragg.**

He knew how to challenge and help you understand the research and material. I also really enjoyed German classes with Dr. (Gerald) Cohen, he was a fun and interesting professor.”

**Adam Smith**, Hist'10  
LeSueur, Minn.

**“My favorite class was Nuclear Chemistry taught by Dr. (Bill) Webb.**

It piqued my interest in the nuclear industry. As a graduate student, half of my courses were in nuclear engineering. That spurred my 36-year career at Bettis Atomic Power Laboratory working on engineering aspects of the nuclear power plants on submarines and aircraft carriers.”

**Ron Mitchell**, ChE'63, MS ChE'64,  
PhD ChE'70  
Tallmadge, Ohio

**“Favorite class? Two actually — Geology 55 and 56, Earth Science I and II, taught by Dr. (Tom) Beveridge (MinE'42).”**

**John R. Walker**, Econ'77  
Russellville, Ark.



# MAKING TORNADO ALLEY SAFER



Growing up in northeast China, **Guirong “Grace” Yan** didn’t see many tornadoes in a country where the number of documented twisters is a fraction of those that hit the United States.

But as her academic career took Yan to several postdoctoral fellowships and then faculty positions in Indiana, Missouri and Texas, the assistant professor of structural engineering gradually found her calling.

As director of S&T’s Wind Hazard Mitigation Laboratory (WHAM), Yan conducts research into wind hazard mitigation and computational fluid dynamics, structural health monitoring, damage detection, and related areas.

She’s built two small-scale tornado simulators that use toy models to mimic the destruction of high-speed twisters and hopes to build a large-scale simulator that she envisions will make S&T a global leader in her field.

Public safety — and preparedness — is central to Yan’s work. That mission is what prompted her to present a TEDxMissouriS&T talk last spring on the vitality of tornado preparation. The talk is available at [rol.la/TEDtornado](http://rol.la/TEDtornado).

Yan relied on a pair of analytical observations more commonly invoked in fields such as cognitive psychology, economics or political science — prospect theory and game theory — during her presentation.

In prospect theory, researchers have found that people are more willing to endure certain-but-smaller financial losses than take the lesser risk of losing a larger amount all at once, Yan explains. So, in that scenario, paying an annual \$5,000 insurance premium over 30 years for a total of \$150,000 is still preferable to a one-time loss of the same amount, she says.

But those behavioral patterns are also influenced by other human factors, such as complacency. So, Yan is developing a virtual reality animation experience that would allow users to realistically determine how their homes would fare in a tornado.

“Based on prospect theory, to convince individuals to structurally reinforce their homes, the key is to inform them of the significant losses induced by tornadoes,” she says. “You can see the wind flow, and you can see how your house is impacted.”

---

**“Tornado resilience is a community responsibility, not an individual one.”**

---

Yan is also tapping game theory — the study of mathematical models of conflict and cooperation among those with competing and overlapping interests — to promote tornado resistance on a broader scale.

“Since tornado resistance is a matter for the entire community, based on game theory, in order to maximize each other’s benefit, the entire community has to play the game cooperatively,” she explains. “Tornado resilience is a community responsibility, not an individual one.”



## CHANCELLOR SEARCH IS UNDERWAY

This past August, University of Missouri President **Mun Choi** announced the formation of a 23-member committee to lead a nationwide search for a chancellor at Missouri S&T. The group is made up of S&T faculty, staff, undergraduate and graduate students, and alumni, including **Tom Voss**, EE'69, retired president and CEO of Ameren Corp. and a member of the S&T Board of Trustees, and **Stephen W. Rector**, PetE'72, MS PetE'73, president of the Miner Alumni Association. Voss co-chairs the committee with **Francisca Oboh-Ikuenobe**, professor of geology and geophysics and biological sciences.

## LIVING LABORATORY HOUSES LEAD BATTERY RESEARCH

This past November, Missouri S&T installed two new advanced lead battery microgrid systems at the EcoVillage, a "living laboratory" that is home to S&T's solar-powered homes. The S&T Microgrid Industrial Consortium plans to use the microgrids to test advancements in lead battery energy storage for their potential use as a renewable energy source in future communities. NorthStar Battery and EnerSys — global battery manufacturers and members of the Advanced Lead Acid Battery Consortium — and the Doe Run Co. donated the equipment and funding to construct the new microgrids.

## PARTNERS FOR PROGRESS

An expansion of the partnership between Missouri S&T and Missouri State University will allow students to pursue a mechanical engineering degree on the Missouri State campus with courses taught by faculty from both institutions. Students began applying this fall. The program will begin in fall 2019.

This is the third S&T engineering program offered through the partnership. For the past decade, Missouri S&T has offered courses in civil engineering and electrical engineering on Missouri State's Springfield campus. More than 200 students have graduated from the cooperative engineering program since its start.

"Missouri S&T and Missouri State forged a commitment to combine our resources and expand our world-class engineering curriculum into southwest Missouri," says **Richard Wlezien**, S&T's vice provost and dean of engineering and computing. "The success of those efforts is based on a true partnership that has paved the path forward toward a broader collaboration that serves as a model for public universities in this state and beyond."

## AWARD NOMINATIONS SOUGHT

The Miner Alumni Association is seeking nominations for alumni awards that will be presented during Homecoming 2019. Awards are presented to alumni and friends of the university for achievement in academia, business, or professional or civic endeavors, as well as for service to their community, the campus, the alumni association or one of its sections. Nominations are due Dec. 31, 2018.

To nominate a deserving Miner, visit [mineralumni.com/nominate](http://mineralumni.com/nominate).





AN EYE FOR

# BUSINESS





Junior **Tim Schreffl**, a midfielder for the Miner men's soccer team, grew up with a passion for sports in a tight-knit family in Germany. After seven months in Milwaukee as a high school foreign exchange student, he knew his dream was to live in the United States.

A college education would have been free for him in Germany, but to come to an American university he had to find a scholarship.

"To my advantage, I was playing soccer at a really high level in Europe, which made it kind of easy to get a good scholarship offer from colleges in the U.S.," Schreffl says.

After receiving offers from universities all across the country, he chose Missouri S&T.

"I looked into the academic programs of the schools that made me an offer and decided that Missouri S&T is the place I want to have a good and successful soccer career and academic career, as well," he says.

Majoring in business with minors in information science and technology and marketing, Schreffl hopes to parlay his education and love of athletics into a job in marketing for a major sports brand.

"I can see myself working for Nike or Adidas in the future," he says.

Schreffl is very close to his family, and being so far away is difficult. But he is up for the challenge thanks to support from his S&T family.

→ "I can see myself working for Nike or Adidas in the future."

"Coming to S&T as a student from another continent makes me face lots of challenges," he says. "Being all by myself in a country, speaking a different language, and being a scholarship athlete requires me to be really focused to be successful. My coach, friends and faculty members help me to stay on track with everything I am doing so that I can be successful."

Schreffl has valued the support and mentorship he has received as an S&T student, and now he's paying it forward.

"S&T team members care a lot about the other members' success, so I definitely learned to not just look out for myself, but look out for others so that they can succeed as well," he says. □





# AMEREN, HYPERION PARTNER WITH S&T TO IMPROVE ENERGY TECHNOLOGY

Energy giant Ameren Corp. and Hyperion Inc., a developing technology company in Ontario, Canada, are working with researchers at Missouri S&T to use fiber optics to monitor high-voltage power lines and equipment. The research could lead to decreased down times for consumers and cost savings for utilities.

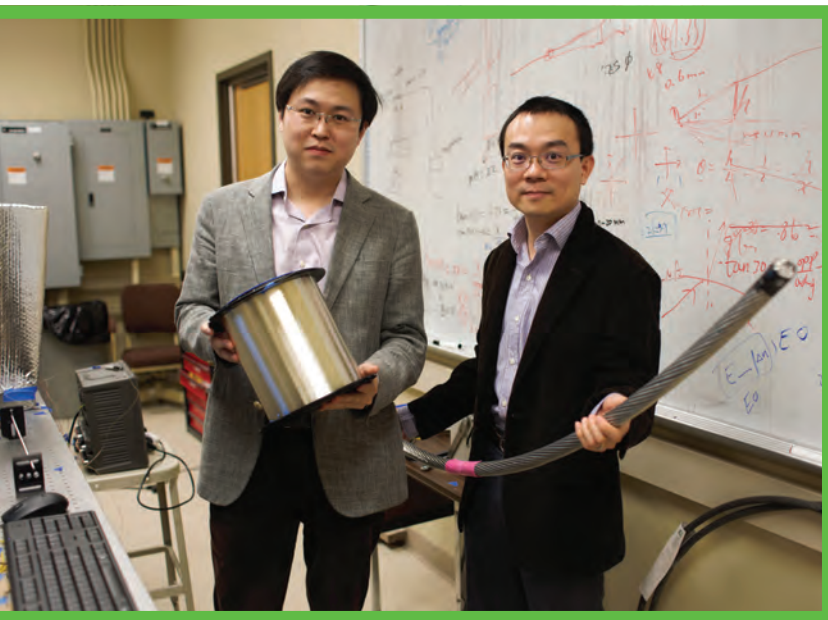

The relationship started when Hyperion was selected to take part in the 2017 Ameren Accelerator program, a partnership with the University of Missouri System, University of Missouri–St. Louis, Accelerate and Capital Innovators. The program assesses, mentors and invests in energy-technology startup companies.

S&T faculty serving as subject matter experts on the Ameren Accelerator review committee learned of Hyperion’s work through the program and proposed the partnership for a new energy infrastructure technology. This year, the Ameren Accelerator is working with six new companies and have already introduced them to S&T researchers.

At S&T, **Jie Huang** (left) and **Rui Bo** (right), assistant professors of electrical and computer engineering, have been studying how advanced sensor technology could be used for power system applications. Their research shows how fiber optics improve the monitoring of high-voltage power lines. When combined with Hyperion’s technology solutions, fiber optics can potentially better monitor high-voltage power equipment.

Hyperion’s fiber optic products monitor the different components in a substation or related power infrastructure like underground cables to monitor the health and performance of power grids. S&T researchers are using fiber optics to monitor temperature and sagging in electric power lines to better assess how well these high-voltage lines are operating.

Fiber optics may be a superior way to monitor electrical systems for a number of reasons, say the S&T researchers. Large transformers produce electromagnetic waves, and the pure silica glass in fiber optics makes them immune to electromagnetic interference, says Huang. The lack of metal makes it a better approach for the power industry, and Huang says the size and shape of the fiber optic cable also allow for more sensitive temperature measurements.

“The fiber optic cable, which is as thin as a human hair, wraps around the winding metal of the transformer. In one millisecond, you can get thousands of temperature readings and the temperature distribution,” says Huang.

Better temperature readings mean a better understanding of power equipment’s performance, as well as a real-time analysis of the equipment’s operation. Providers could prevent or fix problems before major malfunctions like power loss occur. And the readings generated can help increase electricity production, reduce costs and maximize revenues for the utility operator.

Huang and Bo are now attempting to reduce the cost of the system used to collect temperature information from the fiber optics. The researchers have a patent pending for the system, and Hyperion has signed an option agreement to license the intellectual property.

The next steps include field-testing the technology on power lines and transformers and commercially packaging the system.

“In one millisecond, you can get thousands of temperature readings and the temperature distribution.”

# ALUMNI **OF** INFLUENCE

## NOMINATE A MINER FOR 2021

Missouri S&T is seeking nominations for our 2021 Alumni of Influence, the highest alumni honor bestowed by the university. Since we recognized our inaugural honorees in 2011, we've honored 38 distinguished alumni for their personal and professional achievements, service, and legacy. Now we're preparing to recognize a new group of honorees during the university's sesquicentennial celebration. To nominate a Miner, visit [influence.mst.edu/nominate](http://influence.mst.edu/nominate), or forward nominations to **Darlene Ramsay**, executive vice president, Miner Alumni Association, at [ramsayd@mst.edu](mailto:ramsayd@mst.edu).

## 2011 HONOREES

**Thomas Akers**, Math'73,  
MS Math'75

**Dick Arnoldy**, CE'69,  
MS EMgt'73

**Keith Bailey**, ME'64

**Robert Bay**, CE'49

**Jerry Bayless**, CE'59,  
MS CE'62

**Jon Bereisa**, EE'67, MS EE'70

**Jim Bertelsmeyer**, ChE'66

**Philip Chen**, MS ME'65

**Delbert Day**, CerE'58

**Farouk El-Baz**, MS GGph'61,  
PhD GGph'64

**John Fairbanks**, EE'71

**Gary Forsee**, CE'72

**Gary Havener**, Math'62

**Thomas Holmes**, MinE'50

**Vernon Jones**, CE'53

**Fred Kummer**, CE'55

**John Mathes**, CE'67, MS CE'68

**George Mueller**, EE'39

**Zebulun "Zeb" Nash**, ChE'72

**Mariana Rodriguez**, CE'80

**Richard Stegemeier**, PetE'50

**Steve Sullivan**, EE'89

**Cindy Tang**, Econ'85

**John Toomey**, ME'49,  
MS ME'51

**Ed Tuck**, EE'53

**Ted Weise**, EE'67

**Gary White**, CE'85, MS CE'87

**Joan Woodard**, Math'73

## 2016 HONOREES

**Joe Ballard**, MS EMgt'72

**Robert Brackbill**, MinE'42

**Robert Brinkmann**, CE'71

**Matt Coco**, CE'66

**Roger Dorf**, ME'65

**Bipin Doshi**, ChE'62,  
MS ChE'63

**Don Gunther**, CE'60

**Sandra Magnus**, Phys'86,  
MS EE'90

**Dick Vitek**, MS Chem'58

**Roy Wilkens**, EE'66

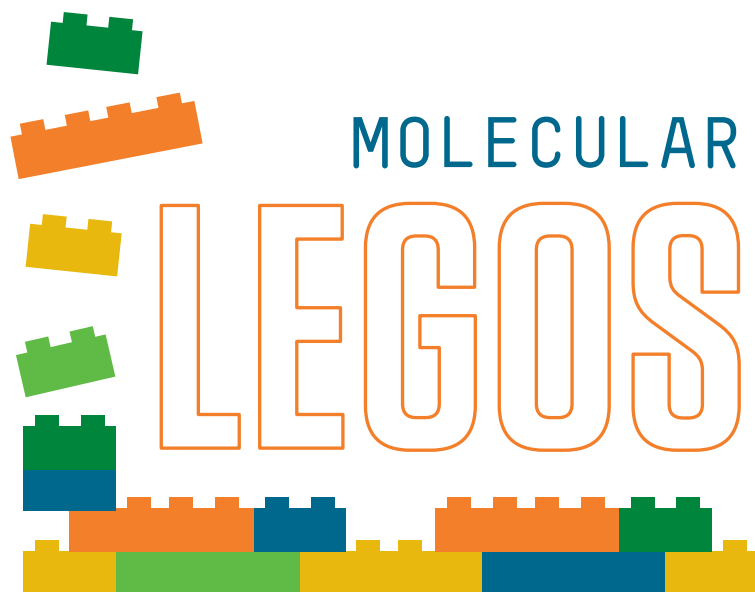

A pair of Missouri S&T scientists are drawing inspiration from toy building blocks to create fixed molecular units used to speed up the material discovery process known as rational design. They'll use these "molecular blocks" to discover materials that could be used to make highly sought solid-state lithium batteries.

"In the materials and solid-state chemistry community, there's always a desire to make materials in a more rational, predictable way," says **Amitava Choudhury**, associate professor of chemistry. "And the all-solid-state battery is a hot research area right now — it's the holy grail of lithium batteries. The right discovery could enable the use of solid-state batteries in hybrid or full-electric vehicles, or anywhere safety predominates, because the all-solid-state versions will be less flammable than current lithium batteries." Today's lithium batteries are made with electrolytes composed of combustible solvents, he adds.

The discovery of new materials with the optimum chemical properties is a slow, tedious process driven by intuition and painstaking trial-and-error experiments. With funding from a \$411,000 grant from the National Science Foundation's Solid State and Materials Chemistry Program, Choudhury and **Aleksandr Chernatynskiy**, assistant professor of physics, hope to improve the material invention process.

The researchers plan to accelerate the discovery process by combining experiments with a theoretical modeling approach that uses fixed molecular units, which function like toy building blocks that come in various shapes and sizes and can be connected in different but predictable ways.

"Instead of using direct chemical elements in our experiments, which are very reactive at high temperatures and can result in undesired products, we'll use pre-determined molecular building blocks, which can be connected only in certain ways that allow us to direct our results," says Choudhury.

Chernatynskiy, a theoretical physicist, will calculate the interactions of the different molecular building blocks to predict the most stable outcomes and determine where adjustments need to be made. This will reduce repetitive experiments and save time and money in the research and development phase.





TO IMPROVE NUCLEAR ENERGY,

# LOOK INSIDE THE FUEL PINS

The search for safe and environmentally friendly renewable energy sources is one of the biggest challenges facing humanity. One environmentally friendly and virtually inexhaustible energy source under development is the next generation of nuclear reactors and, along with them, new types of fuels.

But to test the performance of these new fuels in a timely fashion, we need new methods to investigate the fuel's structural, thermodynamic and chemical characteristics. **Joseph Graham**, assistant professor of nuclear engineering, has developed a mobile platform the size of a microwave that can see through and image spent nuclear fuel using gamma radiation.

"It is hard to see what changes are occurring within a fuel pin when it is actively being irradiated in a nuclear reactor," says Graham, who manages Missouri S&T's nuclear research reactor. "Current measurement capabilities are limited to removing an active fuel rod, waiting for it to cool within a pool of water and then scanning it or cutting it open to try to piece together what took place while it was in the reactor."

The fuel in a reactor — typically uranium — is placed into long metal tubes. The tubes are then sealed and placed in a reactor. These fuel pins undergo nuclear fission, where atoms split apart and release heat that produces electricity. Once the fuel is used up, the pins are removed from the reactor. However, that fuel is still radioactive and must be kept submerged in water to cool for a period of time that can vary from weeks to years.

By lowering Graham's new measuring device into the pool, researchers can begin to measure the fuel's changes throughout the pin between irradiation cycles, almost as soon as it is removed from the core.

"This device will allow us to look at the fuel right out of the oven, so to speak," says Graham. "The work relies on the pins still being highly radioactive and not decaying for too long. The fuel is like a house — at night with the lights on you can see into it, but once the lights are turned out it all becomes dark."

The fuel pins are thin, often the size of an ink pen. Their size allows the scan to pass through them in much the same way a dental X-ray goes through human tissue to produce high-resolution images.

"We need more accident-tolerant fuels for the future, and seeing how the fuel will act while almost in situ will head us in the right direction for safety," says Graham. "With better fuels, we could help solve many challenges facing the creation of new reactors."

Graham's research is supported by the U.S. Department of Energy. He is working with **Hyoung-Koo Lee**, associate professor and head of nuclear engineering, and Nicholas Woolstenhulme, a staff engineer at Idaho National Laboratory.



## S&T CONCLUDES SECOND-LARGEST FUNDRAISING YEAR

Donors gave \$22.6 million in charitable gifts and pledges during the fiscal year that ended June 30, making this the second-largest fundraising year in university history.

This is a 53 percent increase over the past fiscal year and a 112 percent increase compared to two years ago. The university's largest fundraising fiscal year to date was 2007, when charitable gifts totaled more than \$25.4 million.

"We are deeply grateful to our donors for their generous, steadfast and growing support," says Vice Chancellor for University Advancement **Joan Nesbitt**. "Every gift is a vote of confidence in Missouri S&T and our students. We are proud to earn that trust and are committed to delivering on it."

Fundraising highlights for the 2018 fiscal year include the largest gift in university history (see story at right) as well as gifts that completed two building projects — the Clayco Advanced Construction and Materials Laboratory and an addition to the Kummer Student Design Center.

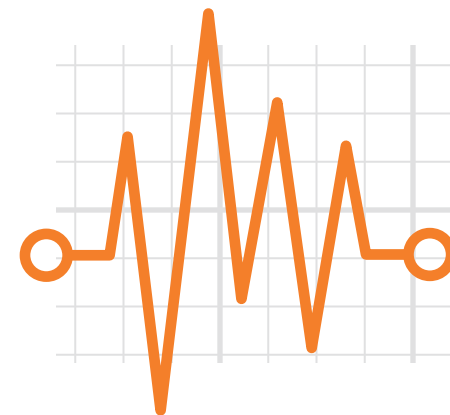

## IN-KIND SEISMIC DATA GIFT IS LARGEST IN S&T HISTORY

Missouri S&T has received the largest gift in its history: an in-kind donation of proprietary seismic data valued at \$6.5 million from Calico Jack Holdings LLC and Zion Energy LLC, both Houston-based oil and gas exploration companies.

The data, which was donated to S&T's geosciences and geological and petroleum engineering department, is a 3-D geologic and seismic survey of 85 square miles along the Texas Gulf Coast.

"We hope this proprietary data set will assist students in multifaceted ways," says **Stephen Zeboski**, GGph'81, founder of Calico Jack Holdings LLC. "Geoscience students can use this data as a learning tool for interpretation and mapping. Petroleum engineering students can use the data for reservoir analysis to assist in prospect generation. I truly valued the time I spent at Rolla, and I am thankful for the events in my career that brought me to this point. Understanding that it started with my education, I have always felt a desire to give back."

The data will be used in classes including Exploration and Development Seismology, Introduction to Geophysical Data Analysis, Seismic Stratigraphy, and Seismic Data Processing.

## STAT HOSTS BARBECUE

Students Today, Alumni Tomorrow (STAT) hosted a free barbecue for students during the group's first meeting of the year. On Aug. 29, 73 students and 12 alumni ate grilled hot dogs while networking and learning more about the student section of the Miner Alumni Association.







# SAFER WATER AND MEDICATIONS, THANKS TO NANOPARTICLES

Over 200,000 people die each year in the U.S. from sepsis, and an estimated 18 million worldwide. Endotoxins, which are fragments of bacterial outer membranes, trigger the septic reaction.

**Sutapa Barua** (above, left), assistant professor of chemical and biochemical engineering, has found a better way to remove those endotoxins from liquids.

She was awarded a federal patent in March for a method that uses polymeric nanoparticles to remove the deadly toxins from water and pharmaceutical formulations. She plans to develop a low-cost, portable bio-filtration kit to synthesize nanoparticles that can absorb water-borne toxins. Barua hopes this research will improve drug safety and increase access to clean drinking water.

The low-cost technique, as outlined in the journal *Nanotechnology*, is a one-step phase separation method that uses a syringe pump to synthesize nanoparticles. Those polymer nanoparticles can remove endotoxins at the rate of nearly 1 million units per milliliter of water — all while using only a few micrograms of the material.

After synthesis, the particles were characterized with a transmission electron microscope and dynamic light scattering. Using a custom-made fluorescence assay, Barua was able to gauge how well the endotoxin bound with the nanoparticles. She used the fluorescent compound BODIPY to tag the endotoxin for identification purposes.

The study “has large implications for the healthcare system, especially for those patients suffering from sepsis,” the journal editors wrote. “This novel removal technique has the potential to be explored for the removal of other deadly toxins that can be found in the bloodstream from a number of different diseases.”

# 50 YEARS OF TEACHING EXCELLENCE

In 1968, Yale University announced it would admit women for the first time, Martin Luther King and Robert Kennedy were assassinated, and young people were grooving to The Rascals' hit "People Got to be Free."

On Sept. 1 of that same year, **Gerald Cohen** and **Gary Long** joined the S&T faculty.

Cohen, a professor of arts, languages and philosophy, was hired to teach Russian and German or French. He taught Russian and German until the mid-1970s, when he solely taught French for a decade. He later switched to teaching German and etymology.

"I've seen the good times and the not-so-good times," says Cohen. "In 1968 only one or two women and African-Americans were enrolled here. I've seen the dramatic increase in female and minority students on campus that helped develop S&T as a full-fledged university.

"Good teachers must be deeply committed to the students, and they should be in love with their subject," says Cohen. "Students who have never studied a foreign language bring an element of fear to the course. Foreign language teachers must teach in a way that strengthens the student's self-confidence."

Long, a professor of chemistry, began his S&T career teaching general and inorganic chemistry courses to undergraduates and graduate students.

His contributions in physical chemistry and chemical physics include research using the Mössbauer effect, the atomic process where a nucleus emits or absorbs gamma rays without losing energy by recoil. His recognition is based on his S&T laboratory's nearly 400 internationally published scientific papers on the topic.

"The best teachers are doing research, and the best researchers are always teaching," says Long.

For the last decade, Long has taught graduate students through his inorganic chemistry lectures. He also teaches students best practices for a successful scientific career, such as how to prepare graphics that are acceptable for publication and how to prepare and convincingly present research at conferences.

"I enjoy teaching a lot, and I enjoy doing it right," Long says.



Photos by Theresa Wiedner



Top: Jerry Cohen (second from left) and Gary Long (second from right) visit with chemistry chair **Rainer Glaser** and Helga Cohen during a reception in their honor. Middle, left: Arts, languages and philosophy chair **Audra Merfeld-Langston** presents Cohen with a plaque honoring his years on faculty. Middle, right: Attendees at the reception signed a guest book for Cohen and Long. Bottom: **Phil Whitefield**, chemistry professor and director of the Center for Research in Energy and Environment, presents Long with a plaque honoring his years of service. They are pictured here with Long's wife, Fernande Grandjean, and Glaser.



# MinerFest

## Miner Homecoming Fall Festival

Photos by Kandi Woessner

The Miner Alumni Association honored a select group of alumni during Homecoming for their accomplishments and their devotion to the association, the campus and its students.

Awardees were recognized during the Miner Legends Luncheon. Honorees, pictured above from left to right, are:

**William Tedesco**, GGph'97

**Karen (Strothkamp) Hogan**, EMgt'02

**Larry Gragg**, Curators' Distinguished Teaching Professor emeritus of history and political science, Missouri S&T

**Dennis Leitterman**, EE'76, MS EE'77

**Diane Butrus**, CSci'85

**Dale Morse**, EE'79

**Traci Walker**, Hist'00

**Wenqing Hu**, assistant professor of mathematics and statistics at Missouri S&T

*Not pictured: David Heikkinen*, ME'93



1. "Miners and Friends" coffee mugs were among the morning-show-themed decor during the Legends Luncheon.
2. Student improv group members **Joseph Styczynski** and **Sabrina Cavender** introduced the awardees during "Miners and Friends," a mock morning show.
3. Just like "Today" show fans line up outside NBC's Rockefeller Square studio, fans of

4. "Miners and Friends" lined up outside the Hasselmann Alumni House "studio" to catch a glimpse of the show.
4. Guests dined family-style and visited during Legends Lunch.
5. Members of the Jackling Jocks from left, **Bill Engelhardt**, ME'60; **Newton Wells**, ME'59; **Dick Boyett**, CE'58; **Art Bell**, ChE'75; **Don McGovern**, ME'58; **Bob Lewis**, CE'61.



# ALUMNI TAKE LEADERSHIP ROLES IN ASSOCIATION

During its annual Homecoming meeting on Oct. 13, the Miner Alumni Association approved the following new and returning board members. We welcome them and thank the departing members for their dedication and loyalty to Missouri S&T and the Miner Alumni Association.

## Executive board

**Stephen W. Rector**, PetE'72, MS PetE'73, president

**Michael McEvilly**, CE'80,  
MS EMgt'81, president-elect

**Daniel Bailey**, GeoE'03,  
MS EMgt'05, vice president

**Ernest K. Banks**, ChE'81, vice president

**Kurt Haslag**, CE'07, vice president

**Delores Hinkle**, PetE'75, vice president

**Ronald W. Jagels**, CE'86,  
MS EMgt'91, vice president

**Christopher Ramsay**, MetE'83,  
MS MetE'85, vice president

**W. Keith Wedge**, GGph'70, MS GGph'71,  
PhD GGph'73, treasurer

**William Brune**, CSci'73, secretary

## Incoming board members

**Brian Bradley**, PetE'86, director-at-large  
(first term)

**Daniel Dziedzic**, EE'83, director-at-large  
(first term)

**John Burgess**, MetE'85, Area 4  
director (first term)

**Tamra Scheibelhofer**, EMgt'95, Area 7  
director (first term)

**Julie Hawkins**, ArchE'06, CE'06, Areas 10-18  
director (first term)

**Robert Telker**, EMgt'82, Areas 10-18  
director (first term)

**Hugh Cole**, EMgt'72, Area 21  
director (second term)

## Departing board members

**Preston Carney**, CE'02,  
MS CE'03, director-at-large

**Alan Erickson**, EE'75, Areas 10-18 director

**Steven Frey**, MS Phys'86, Area 4 director

**Helene Hardy Pierce**, EMgt'83, president

**Bernard Held**, CE'75, Area 7 director

**Stephen Squibb**, ME'98, Areas 10-18 director

**Darrin Talley**, ME'88, director-at-large



3



4



5





1. Students marched with flags from around the world during the Homecoming parade.
2. From left, **William Tedesco**, GGph'97; **Dale Morse**, EE'79; **Larry Gragg**, Curators' Distinguished Teaching Professor emeritus of history and political science; **Dennis Leitterman**, EE'76, MS EE'77; **David Heikkinen**, ME'93, and Heikkinen's son, Joe, pose for a photo with Joe Miner during the Homecoming game.
3. **Tom**, CE'68, MS EMgt'71, and **Linda Owens** visit with fellow Miners during the tailgate.
4. The S&T cheerleaders cheered on the Miners to a 59–21 victory over the William Jewell Cardinals.
5. No. 34, **Deshawn Jones**, scores the first of his three touchdowns.
6. The Student Diversity Initiative collected donations for the Commuter's Commodities food pantry during the tailgate.
7. S&T fans weathered brisk temperatures to cheer on the Miners.
8. During halftime of the football game, **Daryn Bourne**, a senior in civil engineering from Lake Waukomis, Mo., was named Missouri S&T's 2018 Homecoming Queen and **Jacob Hunter**, a senior in mechanical engineering from Imperial, Mo., was named Homecoming King.

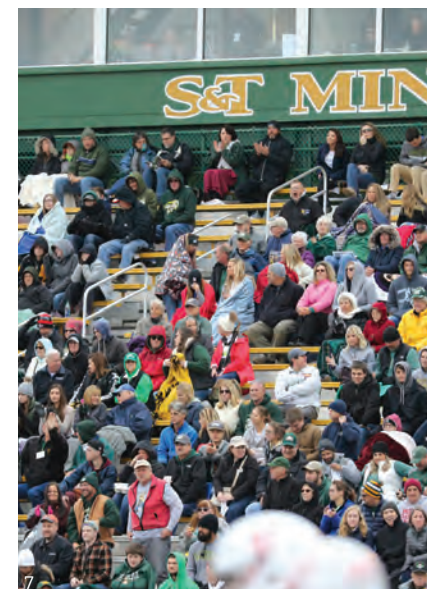





Photo by Joann Stritz

## POURING THE CORNERSTONE ON A BETTER FUTURE

The donors who paved the way to a \$6.5 million lab expansion in Butler-Carlton Civil Engineering Hall gathered in October to pour the cornerstone on the Clayco Advanced Construction and Materials Laboratory.

The lab, which marks the final phase of a \$10.5 million initiative to advance S&T's leadership in infrastructure engineering, was supported with funding from the University of Missouri System, industry partners and alumni.

Real estate and design-build firm Clayco Inc. completed fundraising for the project with a naming gift of \$2 million. The company employs approximately 35 S&T alumni, including chief operating officer and shareholder **Steve Sieckhaus**, CE'87, MS EMgt'94, and executive vice president and shareholder **Tom Sieckhaus**, CE'88.

St. Louis-based ARCO Construction Co. also played an instrumental role. In addition to a \$300,000 gift from the company's founders and a number of employees who are S&T alumni, ARCO championed the project among St. Louis-area construction companies. ARCO was founded by **Dick Arnoldy**, CE'69, MS EMgt'73, retired chairman, and **Jeff Cook**, MS EMgt'94, president and chief executive officer.

A bequest from **James A. Heidman**, CE'65, MS CE'66, was also instrumental to funding the lab.

"Infrastructure is what sustains our quality of life, supports our economy and secures our nation," says **Joel Burken**, Curators' Distinguished Professor and chair of civil, architectural and environmental engineering. "Thanks to our donors' generous support, S&T is rising to the challenge of building a stronger, smarter, safer and more sustainable future."





## HOW MANY BLASTS CAN

# A MINE SEAL TAKE?

**Kyle Perry** is building a cannon to blast things like concrete blocks, hard hats and roof bolts at concrete seals in coal mine tunnels, all to test how well those seals withstand high-speed projectiles.

His work could lead to improved seal design, which translates to safer coal mines.

"We're going to build an explosively driven projectile generator, and basically what that means is a big cannon," says Perry, an assistant professor of mining and nuclear engineering. "It will be 10 to 20 feet long. We will add explosives, concrete blocks, hard hats, roof bolts and other materials that could be left behind in a mining tunnel, and we'll throw that at a seal."

Through these tests, Perry hopes to determine the size and speed a projectile would need to travel to damage the seal.

Perry is working with Strata Worldwide, a mining safety services provider in Atlanta, to build two concrete seals like the ones in active coal mines for the project at the Experimental Mine.

"We will be building two seals — one 120 psi and one 50 psi, and then Kyle will do his best to destroy them," says Mike Fabio, senior development engineer at Strata.

S&T received a \$249,000 grant from the Alpha Foundation for the Improvement of Mine Safety to test seal integrity in underground tunnels that miners close off after finishing with them. The S&T mine was chosen because of its large-scale testing facilities and expertise.

"Damaged seals could start leaking methane into the active portion of the mine," says Perry.

"That could become an explosive mixture and would be dangerous for the miners."

The S&T seal testing started in August 2018 and should be complete by April 2020.

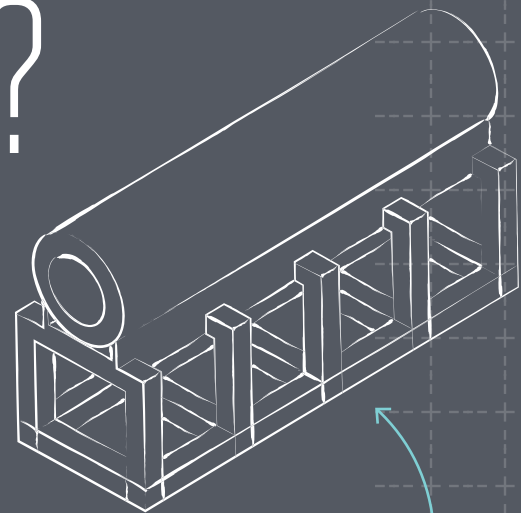

"WE'RE GOING TO BUILD AN EXPLOSIVELY DRIVEN PROJECTILE GENERATOR, AND BASICALLY WHAT THAT MEANS IS A BIG CANNON."



TRUST YOUR GUT ...

# AND YOUR EAR

Within seconds, we make personal choices daily, from what clothes to wear to what music to play in the car on the way to work. A Missouri S&T cognitive neuroscientist says these gut-level decisions are important, and that intuition tends to be accurate in revealing our true preferences.

**Amy Belfi**, assistant professor of psychological science, and her research team set out to determine how quickly people make accurate aesthetic decisions.

Belfi studies music cognition and perception, or the ways music influences our thoughts, feelings and behaviors. She's the lead author of a study on the topic, which appeared in the American Psychological Association's *Journal of Experimental Psychology: General*.

"Aesthetic judgments are subjective evaluations based on how pretty or ugly something is, or whether an observer likes or dislikes the object," says Belfi. "Intuitively, people might think aesthetic judgments require deliberate, contemplative thought."

The research covers a series of four experiments where listeners rated how much they liked or disliked a variety of musical excerpts, ranging in duration from 250 milliseconds to several seconds. Musical pieces also varied based on genre (classical, jazz, electronica) and familiarity of the music.

"Our experiments showed that listeners can accurately identify how much they like a piece of music quite quickly, within hundreds of milliseconds," says Belfi. "When we compared listeners' judgments of shorter excerpts to their judgments of the longest excerpts (10 seconds), they tended to match up quite closely. Listeners were accurately able to determine whether or not they would ultimately like a piece of music within 750 milliseconds. Some genres, such as electronic music, were judged even more quickly.

"We suggest that such rapid judgments represent initial gut-level decisions that are made quickly, but that even these initial judgments are influenced by characteristics such as genre and familiarity," Belfi says.

"Your initial decisions really mean something," she adds. "While limited to aesthetic judgments of music, in this case, the results of our research suggest that our intuitions tend to be quite accurate."

Belfi believes the research will be used by other experimental psychologists who study music cognition, decision-making and preferences.

## S&T MOVES TO 'HIGHLY SELECTIVE' ADMISSIONS STATUS

In June, the Missouri Coordinating Board for Higher Education approved Missouri S&T's request to be designated as "highly selective" in admission criteria. This makes S&T one of only two public universities in the state with this designation. Truman State University is the other.

Under Missouri Department of Higher Education guidelines, students who achieve a score of 27 or better on the ACT or an equivalent score on the SAT are automatically admitted to highly selective institutions.

Highly selective institutions admit first-time, full-time degree-seeking students and transfer students who have a combined "percentile score" of 140 points or greater. The percentile score is determined by adding a student's high school percentile rank and the percentile rank attained on the ACT or SAT.

S&T will continue to provide access to students, including those who may not meet the automatic admission or combined percentile score criteria. MDHE allows highly selective institutions to admit up to 10 percent of first-time, full-time degree-seeking students whose percentile scores are 139 or less.

## SAVE THE DATE: 111TH BEST EVER

All alumni, friends and guests are invited to attend the 111th St. Pat's pre-parade party on Saturday, March 16, at Hasselmann Alumni House, 1100 N. Pine St. in Rolla. A complimentary breakfast will be served before the parade along with a cash bar serving beer, bloody marys and mimosas. Make plans to travel to Rolla for St. Pat's or attend one of the section events in your area. Help make the 111th St. Pat's the Best Ever!





## NIDEC GIVES EE LAB A \$100K BOOST

A \$100,000 gift from St. Louis-based Nidec Motor Corp. will fund the relocation and expansion of the undergraduate power laboratory in Emerson Hall, which houses the electrical and computer engineering department. The gift will also support lab equipment upgrades.

"We have an awesome power program, but our undergraduate lab has been sorely in need of an upgrade," says **Daryl Beetner**, chair of electrical and computer engineering. "Nidec's donation will allow us to modernize and expand the lab equipment and to better prepare our students for jobs in industry."

The gift will allow the lab to be expanded by 25 percent with the relocation. New equipment will include digital power analyzers, multimeters, power supplies, connection panels, cables, oscilloscopes, probes and a motor drive.

"We deeply appreciate our friends at Nidec and their commitment to our students' learning," says **Joan Nesbitt**, vice chancellor for University Advancement. "Their partnership is longstanding and a source of pride for all of us affiliated with S&T."

The power lab is used by every undergraduate student in electrical engineering for required labs in electromechanics and power system design and analysis. Students use the lab to conduct experiments and tests on all aspects of electrical power including motor control, energy conversion, system integration and design optimization. The lab relocation and renovations are expected to be completed by the end of the fall 2018 semester.

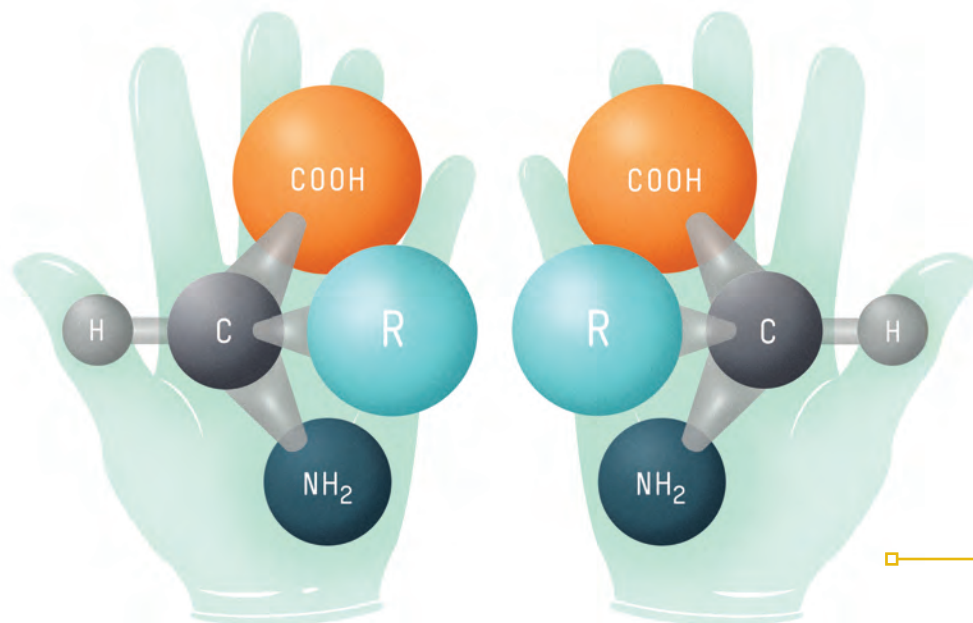

## S&T CHEMIST ROLLS THE DICE TO BETTER IDENTIFY CHIRAL MOLECULES IN DRUGS

High risk, high reward. That's the kind of discovery **Garry "Smitty" Grubbs** is looking for. And this one could significantly reduce drug costs.

Grubbs is working on a new way to rapidly identify the atomic structure of chiral molecules that make up 90 percent of today's drugs. He says it will reduce the time and expenses involved in pharmaceutical development and manufacturing.

Chiral molecules have identical atomic connectivity, but their atoms are arranged in mirror-image configurations that can't be superimposed on each other. Often described as "handedness," the atomic structures of chiral molecules contain similar physical properties (as do the mirror images of the right and left hand), but their chemical properties usually differ.

Grubbs, an assistant professor of chemistry at S&T, received nearly \$60,000 from the National Science Foundation through an early-concept "EAGER" grant for the project. EAGER projects explore untested but potentially transformative research ideas considered "high risk-high payoff" because they involve radically different approaches or new scientific problems.

Grubbs says the pharmaceutical industry spends billions of dollars a year to identify chirality, and several time-consuming methods are required to avoid synthesizing the wrong molecular structure. The wrong molecular structure can cause dangerous physiological effects.

Current techniques include traditional and vibrational circular dichroism, optical rotation, nuclear magnetic resonance and X-ray crystallography. Then they must separate the desired chiral structure from the undesired one using gas or liquid chromatography. Grubbs says the combination of these techniques can take many hours. Using a standardized analysis instead could take less than a minute.

To speed up the process, Grubbs uses an existing, advanced microwave spectroscopy technique that can distinguish molecules in three-dimensional space on molecular effects generated by singular atomic nuclei. Based on these interactions, he hopes to tease out and gather the information to identify chiral molecules.

Because these observations can occur in less than a minute, and at the same time quantify the reaction without having to separate the reaction mixture, Grubbs believes it will drastically speed up chiral discernment, which could ultimately cut costs for the pharmaceutical industry.



# INSPIRED TO SCHOLARSHIP

Never underestimate the power of a protest song. It might not spur everyone to join a cause, but it can influence people in unexpected ways.

For **Nicholas Villanueva**, Hist'06, that inspiration came one day during a history class at S&T when the instructor, assistant professor **Petra DeWitt**, Hist'96, played Barry McGuire's 1965 social protest song "Eve of Destruction."

The song and DeWitt's teaching "really made the time period in history come to life," says Villanueva, who was planning to become a history teacher after graduation. "Many of the discussions in class went far beyond what I learned during my K through 12 education, and I realized that I did not want to feel restricted as an educator. I wanted to have critical conversations with students that might even become controversial."

Now an assistant professor of ethnic studies at the University of Colorado Boulder, Villanueva is not shying away from controversial topics. His 2017 book, *Lynching of Mexicans in the Texas Borderlands*, examines the mob violence against Mexicans between 1910 and 1920. Those were the years of the Mexican Revolution, when refugees flooded into the United States.

"The Mexican Revolution destabilized the borderland and intensified Anglo fear and suspicion of ethnic Mexicans," Villanueva writes in a chapter on the "legal" lynching of a Mexican boy who was under the legal age for execution. "The destabilization led to an increase of hostile campaigns directed against ethnic Mexicans, and these crimes often went unpunished."

Villanueva's book received critical acclaim, including the National Association for Chicana and Chicano Studies 2018 Non-Fiction Prize and a 2017 Southwestern Studies Book Prize from the University of Texas and the Border Regional Library Association.

In addition to DeWitt, Villanueva credits three other history faculty for preparing him for an academic career: his undergraduate advisor, Curators' Distinguished Teaching Professor **Diana Ahmad**, whom he acknowledges in his book; current department chair **Shannon Fogg**, for setting up an independent study course that "helped me realize how much work is involved in graduate studies"; and **Larry Gragg**, Curators' Distinguished Teaching Professor emeritus, who "stressed the importance of a strong writing sample for my (graduate school) application."

"You can say that this department took me under its wing and really wanted to see that I succeeded," he says.

Villanueva's second book project, titled *Critical Sport Studies: Social Issues in Sport and Practical Solutions*, aligns with another academic focus of his as director of CU Boulder's critical sports studies program.



A photograph of a student in a classroom, viewed from the side, looking down at an open book on a desk. The student is wearing a dark blue long-sleeved shirt. The background is blurred, showing other students in a classroom setting. The text 'MENTORS, GUIDES' is overlaid in large, bold, lime green letters.

# **MENTORS, GUIDES**



# LEADERS,

## A LOOK AT THE NEW FACES OF LEARNING AT MISSOURI S&T.

By Mary Helen Stoltz, [mhstoltz@mst.edu](mailto:mhstoltz@mst.edu)

Missouri S&T's faculty members are passionate about teaching. They are highly credentialed. They came to S&T for many different — although quite specific — reasons, and now that they're here, they are productive in ways that extend beyond the classroom and the lab.

From advising the Rock Climbing Club — and turning physical feats on the rock face into mental challenges in the classroom — to taking a group of college students throughout the Western Hemisphere to help solve the clean-water crisis in developing countries, these experiences help our faculty build bonds with their students that form the foundation of student success.

Whether they came from a small Midwestern college or a top-tier research university, our faculty find S&T's

diversity, STEM focus and unique student body a real draw. Some were also lured by research facilities and small class sizes that are unavailable at peer institutions.

Missouri S&T is known for graduating tomorrow's problem-solvers, tomorrow's leaders. That's thanks in no small part to the educators who have imparted their wisdom, whether through research, teaching or mentorship.

Read on and meet a few of the new faces of learning at S&T. ■



# THE ROAD TO ROLLA

## NEW FACULTY SEEK TO MAKE A DIFFERENCE AT S&T

By Alan Scher Zagier, zagiera@mst.edu

**W**hen he first came to campus a decade ago, **David Lipke** had no idea that he would one day call Missouri S&T home. The Georgia Institute of Technology Ph.D. student instead had a more narrow focus: gaining access to a piece of specialized equipment that his home institution — one of the nation's top programs in materials science and engineering — didn't have at the time.

"That's one of the uncommon strengths of this campus, that it maintains those facilities," says Lipke, an assistant professor of ceramic engineering who joined S&T in 2017.

Whether engineering or psychology, computer science or history, the professors whose academic careers lead them to Rolla often hail from some of the top institutions of higher education in this country and beyond, from Oxford to the Ivy League.

Their reasons are varied, but interviews with members of the current crop of new faculty and recent hires suggest a common thread: the chance to conduct world-class research

and teach some of the best and brightest while living in a family-friendly community where the commute is usually measured in minutes, not hours.

"I'm much happier in a small town like Rolla than a big city like L.A. or the huge Bay Area," says **Jason Murphy**, an assistant professor of mathematics and statistics since 2017 who spent three years as a postdoctoral fellow at the University of California, Berkeley and earned his doctorate from the University of California, Los Angeles. "It was easy for me to make the choice to come here."

"It felt like home," says **William Gillis**, ME'99, PhD EMgt'13, an assistant teaching professor in architectural engineering. "While walking around campus as a student in 1995, I had a distinct feeling that I was supposed to be here, though I had no clue why. Now, throughout my time at S&T as a student, engineer and instructor, I have met many amazing people all across the campus. So many of them reached out, supported me and helped me to succeed."

**YUN SEONG SONG**: ASSISTANT PROFESSOR OF  
MECHANICAL AND AEROSPACE ENGINEERING

A man with dark hair, wearing a blue button-down shirt, stands in a brightly lit hallway with a grid ceiling. He is smiling slightly and looking towards the camera. The background is slightly blurred, showing the perspective of the hallway.

*“What convinced me to come here was the faculty support for young faculty.”*







AMY BELFI: ASSISTANT PROFESSOR  
OF PSYCHOLOGICAL SCIENCE

*“This is a place where I could explore the questions I wanted to answer.”*





# “...I had a distinct feeling that I was supposed to be here...”

For **Amy Belfi**, an assistant professor of psychological science, trading the sights and sounds of Greenwich Village as a New York University postdoctoral researcher for her first faculty job at Missouri S&T was admittedly an adjustment.

It also was a homecoming for a St. Louis native who spent her undergraduate years at St. Olaf College in Minnesota and earned a Ph.D. in neuroscience from the University of Iowa.

“Our apartment in New York was a 400-foot studio walk-up,” she recalls with a laugh. “It’s so nice to have a house that feels like a palace. ... Now I don’t miss that much about New York.”

An expert in how the human brain reacts and responds to music, she left a department with nearly 50 faculty members, and a bevy of brain-imaging equipment, for a much smaller group of colleagues at a university better known for its engineering programs. In Belfi’s case, that meant quickly finding a supportive environment where she can stand out rather than risk getting lost in the shuffle.

“It feels so much more collegial here,” says Belfi, while emphasizing the “amazing” time she had at NYU. “I didn’t really know a lot of people at NYU outside my lab. I felt a bit sequestered.”

“This is a place where I could explore the questions I wanted to answer.”

Credit *Star Wars* for luring **Yun Seong Song** to S&T by way of Carnegie Mellon University, the Massachusetts Institute of Technology and Georgia Tech.

The assistant professor of mechanical and aerospace engineering, whose research focuses on human-robot interaction, fell hard for the field after watching the George Lucas film series as a child.

“I wanted to build a C-3PO, a robot that moves like a human,” he says.

That childhood passion led Song to study engineering as an undergraduate in his native Korea before stops in Pittsburgh for his master’s degree, greater Boston for his Ph.D. and both Atlanta and Switzerland for a pair of postdoctoral fellowships. He joined S&T in 2016.

“It wasn’t a difficult choice,” Song says. “What convinced me to come here was the faculty support for young faculty. It’s really the culture of the department.”

“There’s a lot of uncertainty as you transition from a postdoc to a young faculty member,” he continues. “I hear stories from my friends who started their careers at the same time. That support is not always available.”

Murphy, another St. Louis native and a scholar of harmonic analysis and partial differential equations, was also familiar with the campus and community. He too cites the advantage of working in an academic department where more isn’t necessarily better.

“This department is a tight-knit group of like-minded people who all seem to be on the same team,” he says. “It’s easier to feel like you as an individual can make a positive difference.”

Lipke, the ceramic engineer whose first faculty position was at Alfred University in New York, singles out the campus’ Center for Advancing Faculty Excellence for its role in providing new faculty with both resources and a forum to engage with peers from across academic disciplines.

“It’s really clear to me that the school values and supports its new faculty,” he says. “They provide you with all kinds of perspectives and open the doors to network. Even as someone who already has four years of faculty experience on the tenure track, I’m still learning and benefiting from that program. That’s something you don’t see at a lot of other schools. It’s reflective of the culture here.” ■

**WILLIAM GILLIS:**  
ASSISTANT TEACHING  
PROFESSOR IN  
ARCHITECTURAL  
ENGINEERING

**JASON MURPHY:**  
ASSISTANT PROFESSOR  
OF MATHEMATICS AND  
STATISTICS



**DAVID LIPKE** : ASSISTANT PROFESSOR  
OF CERAMIC ENGINEERING



# TEACHING STUDENTS IS PRIORITY NO. 1

By Sarah Potter, sarah.potter@mst.edu

When **Michelle Schwartz** arrived for a tour of Missouri S&T, students kept interrupting her guide, **Larry Gragg**, Curators' Distinguished Teaching Professor emeritus and former chair of history and political science, to say hello and talk with him. Those interactions drew her to S&T.

*“Everything we do is based on what is best for the students.”*

“I liked that he knew the students by name,” says Schwartz, an assistant teaching professor of teacher education and certification. “This isn’t a campus where the students just come to class, and you don’t get to know them. But rather I could tell that relationships are important here, and that is important to me as a teacher.”

## DEMONSTRATIONS OF GREAT TEACHING

Schwartz is helping prepare the next generation of K–12 teachers in the teacher education and certification department, and she says the Missouri S&T faculty exhibit many key elements of good teaching. At an active-learning day on campus, she saw classroom videos other faculty members had made.

“It was great seeing them engage with their students,” says Schwartz. “I saw great questioning skills among the faculty as well as a variety of formative assessment tools such as clickers, Quizzizz and Plickers. The faculty here do a great job of staying up-to-date on the latest educational trends.”

Some faculty members are rethinking the large lecture-hall style of teaching students at the college level.

**Amardeep Kaur**, MS EE’09, PhD EE’14, assistant teaching professor of electrical and computer engineering, says it was a challenge, at first, teaching electrical circuits to 200 students who are not all electrical engineering majors. She improved student engagement through feedback from colleagues. The result is less lecture time and a more interactive classroom experience — a partially “flipped classroom” where students learn some content on their own before class.

Right, top: Sarah Hercula teaches linguistics courses in English and technical communication. She challenges her students to use their critical-thinking skills and believes teaching is the top priority for faculty members.

Right, bottom: Michelle Schwartz teaches S&T’s future teachers. She says that building a relationship with her students leads to success in the classroom. She believes S&T faculty do a great job of keeping up with the latest educational trends.

Far right: Amardeep Kaur earned two graduate degrees at S&T and decided to join the faculty after she graduated. She also believes in the power of relationship-building — particularly outside the classroom. She advises the S&T student chapter of IEEE.

“Once in class, we focus on applying those concepts, discussing their application and value in real-world applications and thus providing students more time to spend on each concept,” says Kaur. “The intent of all of our activities is to engage all the students that may have different levels of preparation or understanding and bring their shared knowledge together to get rid of misconceptions.”

Her students say her teaching style is to make sure they know the material inside and out.

“She cared that we not only know how to do the math but understand the concepts as well,” says **Joseph Reger**, a senior in mechanical engineering. “Dr. Kaur was always available and made time for her students regarding the material.”

That could be because it hasn’t been too long since Kaur was a student herself.

“I was a graduate student here and got to experience the campus community for six years before I became part of the faculty,” Kaur says. “The campus atmosphere, congenial colleagues, helpful seniors, and transparent and easy-to-approach administrators are all great assets, but a smile on everybody’s face is the highlight for me.”

Kaur says S&T’s pride in diversity and inclusion makes students, faculty and staff all feel like they belong in Rolla.

“Finding the type of campus culture that is respectful toward everyone — is inclusive, open and promotes a healthy atmosphere for students to learn in — is not very easy,” says Kaur. “I am glad that I was able to find that here.”

## FACILITATORS OF LEARNING

**Sarah Hercula**, assistant professor of applied linguistics, started out teaching high school before deciding she wanted



**SARAH HERCULA:** ASSISTANT PROFESSOR OF APPLIED LINGUISTICS



**MICHELLE SCHWARTZE:** ASSISTANT TEACHING PROFESSOR OF TEACHER EDUCATION AND CERTIFICATION



**AMARDEEP KAUR:** ASSISTANT TEACHING PROFESSOR OF ELECTRICAL AND COMPUTER ENGINEERING

to teach at the college level. She sees herself more as a facilitator of learning than as a transmitter of knowledge.

"The students at S&T are motivated and dedicated; I have never before worked with students who have more drive and commitment to their studies," Hercula says. "Their energy and enthusiasm allows for deeper exploration of the content both in and outside the classroom, as students are prepared and eager to learn, and they don't shy away from considering important questions or pivotal societal problems."

One of her students, **Lindsay McNamee**, says Hercula challenged her to search out and follow evidence to reach her own conclusions in her classwork.

"Dr. Hercula's influence has been unique in the sense of how she engaged that part of us to make her students active learners in the classroom," says McNamee, a junior in English education at S&T. "One of my favorite things has been how she has challenged me to be critical in my thinking and not just accept what I am taught."

Hercula says that faculty see teaching as their top priority at Missouri S&T.

"Everything we do is based on what is best for the students. We're constantly thinking about how to reach our students and improve our craft," she says. "There's a passion for teaching in the English department as an essential part of what we do."

Schwartze, Kaur and Hercula all pointed to relationship-building as key to student learning.

"If students don't trust you or don't think you have their best interest at heart, then they will not want to learn from you," says Schwartze. "When you build a strong relationship with your students, they will also be more comfortable in your class and want to share more."

## OUTSIDE THE CLASSROOM

One way S&T faculty are building those relationships is by taking time outside of teaching hours to help advise students

through design teams, student organizations and extracurricular activities.

Kaur advises the student chapter of the Institute of Electrical and Electronics Engineers (IEEE), a large professional organization dedicated to advancing technology to benefit humanity. She's also helped international students feel welcome by advising the India Association for two years.

"The most rewarding part of the process has been knowing the students beyond the classroom," says Kaur. "The students are comfortable because they know me, and I am comfortable because I see familiar faces in class. The whole dynamic allows for a better classroom culture."

"Dr. Kaur is the person's teacher first, but she wants to be the person's friend second," says Reger. "If I have any problems with electrical components in any other class, I feel confident going by her office to ask her for help." ■





# TEACHING FOR THE

# REAL WORLD

By Delia Croessmann, [croessmann@msst.edu](mailto:croessmann@msst.edu)

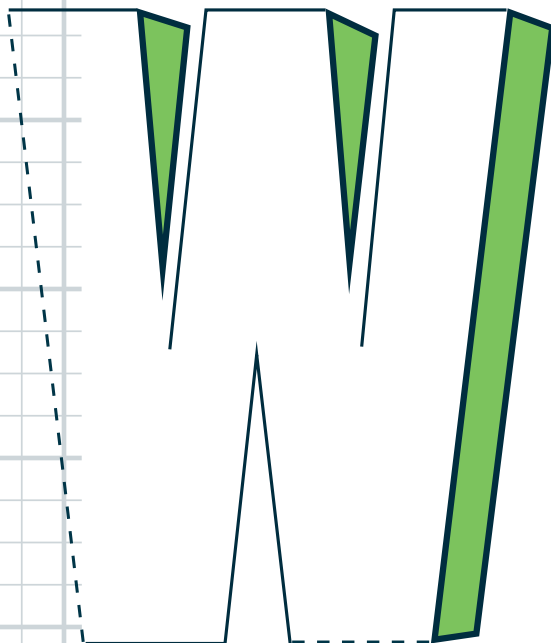

When you recall your most influential college professors, what comes to mind?

They were the ones who showed a sincere interest in you and the outcome of your education. Their words of encouragement and hands-on involvement helped you find your way and build confidence. They were the teachers who clued you in to experiences that helped you launch into a career or graduate school.

**Julie Semon**, an assistant professor of biological sciences since 2014, is one such educator. True to her research interests, Semon teaches courses in stem cell biology, tissue engineering, and biological design and innovation.

Beyond her course load, she mentors nine undergraduates and a graduate student in her regenerative medicine stem cell lab.

Semon recently reconstructed an undergraduate biological design and innovation class that gave six student teams the opportunity to create new approaches to biological challenges that would offer both health and economic benefits. The student teams took their ideas through market evaluations, research designs and cost-of-proof concepts.

Right: Christi Luks, an associate teaching professor of chemical and biochemical engineering at Missouri S&T, advises the student chapter of the American Institute of Chemical Engineers, the S&T Chem-E-Car Team and Engineers Without Borders. She is pictured here with local children on a recent trip to Honduras with EWB.

Below: Julie Semon, an assistant professor of biological sciences, mentors nine undergraduates and a graduate student in her regenerative medicine lab. She credits a recent hands-on, real-world project for changing her views on the importance of learning outside the classroom.



*It gives me a chance to really do engineering."*

"The hands-on, real-life experiences with my students caused me to think differently about taking their learning outside of the classroom," Semon says.

Her student teams delivered some significant results, including borate dental implants, a high-tech treatment for sexually transmitted infections and an Uber-like, ride-sharing system for home-care nurses. Most of the teams also landed funding or have filed patent disclosures to advance their creations. One team's prototype is now in test mode at BioSTL in Clayton, Mo.

What started out as a one-semester class for Semon is continuing on as a project follow-up class.

"We're investigating ways to funnel S&T students into other relevant programs, using what they've learned in our program. We're talking to the medical school at the

University of Missouri-Columbia, the Missouri Department of Conservation, the USDA Forest Service and with companies affiliated with S&T's Innovation Park to help students with startups and support their future goals."

**Devin Burns**, assistant professor of psychological science, joined S&T in 2016 and teaches undergraduate classes in research methods and sensation and perception, and a graduate-level course in psychometrics, the science of measuring mental capacities and processes. He appreciates the type of students that Missouri S&T attracts.

"I have found a much greater willingness to learn, experiment and be pushed among the students here than I've seen at the other colleges where I've taught," says Burns. "There are a lot of really smart students here looking to get involved in research."



JULIE SEMON: ASSISTANT PROFESSOR  
OF BIOLOGICAL SCIENCES





**DEVIN BURNS:** ASSISTANT PROFESSOR OF PSYCHOLOGICAL SCIENCE



In his research methods class, Burns' students coordinated with labs from three other universities on a research project and submitted their results to a peer-reviewed journal. Their finding disputes earlier, third-party research that showed wearing particular kinds of clothing could influence a person's core cognitive processes, such as attention. The study aggregated Burns' expertise in research methods, sensation and perception, and psychometrics into a single, comprehensive learning experience.

"I can take the time to tailor projects to different students' needs, letting each one select a topic that appropriately challenges their ability level," he says.

Burns grew up in Albuquerque, N.M., where he learned to love the outdoors. Now he advises the S&T Rock Climbing Club. Its outings draw students across all majors and experience levels.

Left: As an assistant professor of psychological science, Devin Burns teaches undergraduate courses in research methods and sensation and perception. He also advises the S&T Rock Climbing Club and uses climbing to demonstrate how we fundamentally perceive the world in terms of how we interact with it.

Above: In her biological design and innovation class, Julie Semon gave her students a chance to find solutions to biological challenges with both economic and health benefits.



# *“I love being pushed by my students to explore new topics that they’re interested in that may not be my area of expertise.”*

Burns believes the principles of perception and sensation are important for engineers working in computer science and robotics, and he uses the example of climbing to demonstrate how we fundamentally perceive the world in terms of how we interact with it, rather than in objective units of measurement, like feet and inches.

“I love being pushed by my students to explore new topics that they’re interested in that may not be my area of expertise,” Burns says. “I do my best to position myself as a collaborator, jointly confronting new and confusing ideas.”

**Christi Luks**, associate teaching professor of chemical and biochemical engineering, is always looking for new ways to enhance her students’ learning.

Luks is a faculty advisor to three student groups: the student chapter of the American Institute of Chemical Engineering (AIChE); the S&T Chem-E-Car Team, which constructs a car powered by chemical reactions; and a sub-team for Engineers Without Borders (EWB).

With EWB, Luks is helping students develop sustainable engineering projects for communities in Latin America. As founder of an EWB chapter at the University of Tulsa, where she previously taught, Luks has managed student engineering teams in small communities in Bolivia, Guatemala and Honduras for 12 years.

“It gives me a chance to really do engineering,” says Luks. “I’m very practical and love forming relationships with the students. I know we

will communicate years from now because we’re making a difference in lots of lives.”

Starting her fifth year at S&T, Luks is currently working stateside with the EWB team on an “eco latrine” project to design biochemical methods to process human waste into fertilizer to improve crop yield. They plan to take the project to a university in Nicaragua to further its use in disadvantaged international communities.

“Late at night, in a foreign country, after 110-degree days with no air conditioning, you form bonds with the students,” says Luks. “It is always so great when you see them later and know you helped ground them for success in their field.” ■

## *HONORING RISING STARS IN THE CLASSROOM*

By Maridel Allinder, allinderm@mst.edu

**I**rina Ivliyeva is emphatic about why the Miner Alumni Association’s Class of ‘42 Excellence in Teaching Award is important. It shines the spotlight on a tough job: being an early career faculty member at S&T.

“It takes a semester just to get a feel for the culture and students,” says Ivliyeva, a professor of Russian and chair of the Outstanding Teaching Awards Committee, which also administers the Class of ‘42 award. “A teacher has to click not just on an intellectual level, but also on a human level. It’s extremely difficult to earn high student-evaluation scores.”

The judging criteria for the Class of ‘42 award is the same as that for the Outstanding Teaching Awards — a candidate must score at least a 3.6 out of a possible 4.0 on student evaluations.

There is one difference: only tenure-track faculty members who are not yet tenured are eligible for the Class of ‘42 award.

“It’s a little like a lifetime achievement award for junior faculty members,” says Ivliyeva. “The campuswide recognition is important, and it counts when it comes to promotion and tenure.” Honorees receive a cash award of \$2,000.

The Class of ‘42 Excellence in Teaching Award was established in 1992 when class members celebrated the 50th anniversary of their graduation. **Bob Brackbill**, MinE’42, was among the class leaders who spearheaded fundraising for two endowments: one for a scholarship and the other for the teaching award.

“We pushed everyone pretty hard to get involved with our fundraising efforts,” said Brackbill in a *Missouri S&T Magazine* story published in 2009. Also quoted was another classmate, the late **George Bradshaw**, ME’42: “We all had been through the Depression as children, and so we learned to live frugally and to help others. We continue that expression of helping others through our endowments.”

The first Class of ‘42 award was presented in 1993 and 25 early career faculty members have been honored to date, including Ivliyeva, who received the award in 2007. **Max Tohline**, EngI’07, assistant professor of art and film, received the 2017 award, and **Wenqing Hu**, assistant professor of mathematics and statistics, was honored in 2018.

“Many awards are based on years of experience, but the Class of ‘42 award is different,” says Ivliyeva. “It spotlights rising stars who illuminate the classroom.”



# COME TOGETHER

With over 50 sections across the country, the Miner Alumni Association offers an abundance of opportunities for you to expand your professional and social circle. From sporting events to St. Pat's festivities, Miners like you get together year-round to connect and play. Don't miss out on the fun. Check out the events calendar at [mineralumni.com/events](http://mineralumni.com/events).



Kansas City student send-off



MD-VA-DC section St. Pat's celebration



Bay Area Oktoberfest

# LET YOUR VOICE BE HEARD

Your opinion matters to the Miner Alumni Association, which represents over 60,000 alumni. If you have comments, questions or ideas, please share them with your elected representatives listed below.

## PRESIDENT

Stephen W. Rector '72

## PRESIDENT-ELECT

Michael McEvilly '80

## VICE PRESIDENTS

Daniel Bailey '03

Ernest K. Banks '81

Kurt Haslag '07

Delores Hinkle '75

Ronald W. Jagels '86

Christopher Ramsay '83

## TREASURER

W. Keith Wedge '70

## SECRETARY

William Brune '73

## DIRECTORS-AT-LARGE

Robert "R.J." Agee '03

Tessa C. Baughman '04

Brian Bradley '86

Daniel Dziejzik '83

Michael Emanuel '87

George Schindler '73

## AREA DIRECTORS

Area 1: Rhonda Pautler '87

Area 2: Joshua Hoffman '07

Area 3: Daniel Ryan '12

Area 4: John Burgess '85

Area 5: John Stutsman '77

Area 6: Gary Hines '95

Area 7: Tamra Scheibelhofer '95

Area 8: Richard Berning '69

Area 9: Michael Gross '88

## Areas 10-18:

Kenneth Bandelier '97

Elizabeth Baumbach '09

Julie Hawkins '06

Rachel Jung '09

William McAllister III '76

Steven Puzach '09

Carl Schmitz '10

Robert Telker '82

Chadwell Vail '05

Area 19: Jennifer Marshall '96

Area 20: John R. Campbell '74

Area 21: Hugh Cole '72

Area 22: vacant

Area 23: Pete Heerboth '03

Area 24: David W. Heineck '79

## PAST PRESIDENTS

Robert D. Bay '49

Robert T. Berry '72

James E. Bertelsmeyer '66

Robert M. Brackbill '42

Matteo A. Coco '66

John Eash '79

Richard W. Eimer Jr. '71

Helene Hardy Pierce '83

Larry L. Hendren '73

Zebulun Nash '72

James R. Patterson '54

Darlene (Meloy) Ramsay '84

Perrin R. Roller '80

Susan Hadley Rothschild '74

Gerald L. Stevenson '59

To contact your representatives, go to [mineralumni.com](http://mineralumni.com).

# CLASS NOTES

## SHARE A CLASS NOTE

Let your classmates know what you've been doing. Send us information about your professional and personal accomplishments — career changes or promotions, weddings, births and other news — and we will publish it in an upcoming issue. Email your update and a high-resolution photo (if available) to [alumni@mst.edu](mailto:alumni@mst.edu).

Deadline:

**Summer issue — March 15**

## PUBLICATION POLICY

We publish information submitted by alumni, news submitted by employers of alumni, and selected news stories that mention alumni and their affiliation with Missouri S&T. We are happy to announce weddings, births, promotions and other special occasions after they have occurred. We will print addresses if specifically requested to do so by the alumnus/alumna submitting the note and will mention a spouse's name if it is specifically included in the submission. We reserve the right to edit alumni notes and will use submitted print-quality photos as space permits. Due to the production time required for each issue, submissions may take up to six months to appear. Your patience is appreciated.

1951

**Earl Jackson**, MinE: "Lou and I just celebrated our 91st birthdays and 70-plus years of marriage. Our granddaughter just presented us with our seventh great-grandchild. Lou's Alzheimer's disease prevents us from much traveling. Life is good, though."

1953

**John R. Ford**, CerE, after leaving Rolla joined the Naval Aviation Cadet program and reported to Pensacola, Fla. He served with VS 27 flying the Grumman S2F at Norfolk NAS and on USS *Valley Forge*, *Leyte* and *Wasp*. After his military career, he worked at Sangamo Electric Co. in Springfield, Ill.; Vernay Labs Inc. in Yellow Springs, Ohio; Ion Capacitor Corp. in Columbia City, Ind.; and finally at Vernay Products Inc. in Thomasville, Ga. Ford also spent many years in private consulting and is now retired.

1957

**Russell Wege**, PetE: "Life is good. I enjoy good health, have a vegetable garden, and enjoy camping and fishing. My wife and I planned an eastern Mediterranean Bible cruise in October."

1961

**J. Dale West**, ChE: "Following graduation, I served in the U.S. Army Corps of Engineers until 1963 at which time I began employment at Eastman Chemical in Longview, Texas, then a division of Eastman Kodak. Several years ago, I retired from Eastman Chemical Co. after 35-plus years of service as a staff engineer, holding several management-level positions, including project manager for constructing two successive UNIPOL Polypropylene production units. I attended Texas A&M and earned a master's degree in chemical engineering in 1971. Soon after retirement, I began teaching at LeTourneau University. Last year, I retired

as adjunct professor of engineering after 15 years of service. My wife, Verlyn, and I have been married 57 years and have two children and two granddaughters."

1964

**Michael Meehan**, ChE: "Sue and I are enjoying retirement in Wake Forest, N.C."

1970

**Harry J. Auman**, EE, was inducted into the Academy of Electrical and Computer Engineering.

1974

**Roger Phillips**, CE, retired from Toth and Associates Inc. in Springfield, Mo. He worked for the firm for over eight years as a professional engineer and land surveyor followed by a career in private practice for over 40 years. He has since retired and is enjoying traveling.

**Michael Whitson**, ME: "I am now officially retired after 33 years at Armco/AK Steel and 10 years at Zane



Photo submitted

## BENNINGTON RIDES THE PONY EXPRESS TRAIL

**Leslie Bennington**, ME'68, took part in the National Pony Express Association's 2018 spring 10-day ride, which covered 2,000 miles between St. Joseph, Mo., and Sacramento, Calif. Each year, hundreds of association members re-ride the over-150-year-old Pony Express route on horseback, traveling through eight states. They pass off a mailbag — called a mochila — to each other at each stop.

The National Pony Express Association is a non-profit, volunteer-led historical organization that preserves the original Pony Express trail to continue the memory and importance of Pony Express in American history.

Bennington has been involved with the association for 38 years, serving as past national president and as of spring 2018, Wyoming state division president.





## RICHARDSON WINS NATIONAL TEACHING AWARD

**David Richardson**, CE'71, MS CE'73, PhD CE'84, Chancellor's Professor of civil, architectural and environmental engineering, received the James M. Robbins Excellence in Teaching Award from the Chi Epsilon national civil engineering honor society.

One nomination cited Richardson's teaching track record, which includes 11 separate graduate and undergraduate courses — four of which Richardson created — taken by more than 4,000 students.

Richardson has taught at Missouri S&T since 1984 and has received 18 national and campus teaching awards, as well as 12 faculty and professional awards. In 2017, he was awarded the Alumni Merit Award from the Miner Alumni Association. Richardson is a registered professional engineer in two states, a fellow of the American Concrete Institute and member of the Missouri S&T Academy of Civil Engineers. He has served as director of the QC/QA Training and Certification program at S&T for 20 years, and has authored over 60 publications.

"Successful teaching should be viewed as student-learning facilitation," Richardson says. "The successful teacher should be passionate about the subject matter and willing to devote great personal effort in self-education about all aspects of the subject matter."

State College. My wife and I are now traveling and enjoying our four grandkids."

### 1976

**Robert Brandt**, EE, was recently elevated to senior engineer in IEEE.

**Bob Fleischman**, MetE, MS MetE'78, received the Oklahoma Arts Council 2018 Governor's Arts Award.

### 1977

**Patricia Carson**, EMgt, retired after 40 years in engineering and finance in a corporate position. She currently serves as mayor of the town of North, S.C. "The discipline of an engineering education from Missouri School of Mines and Metallurgy has been fundamental in my success in former and current positions."

### 1978

**Daniel Reed**, CSci, a computational science scholar at the University of Iowa and a former Microsoft executive, was named senior vice president of academic affairs at the University of Utah.

### 1981

**Terry Bodine**, CE, joined Hanson Professional Services Inc.'s Chicago regional office.

### 1982

**Janet Kavandi**, MS Chem, was endorsed by the NASA administrator as his pick for the next deputy administrator.

### 1983

**Linda (Bangert) Weathered**, AE: "I retired after 37-plus years with NASA Langley Research Center. I spent 15 years at the 16-foot transonic wind tunnel researching thrust vectoring and reversing nozzles, and propulsion integration for fighter/attack aircraft. I was high lift lead for the High Speed Research Program, which ended in 1999, deputy and project manager for the Quiet Aircraft Technology Program, and aerodynamics lead in the Supersonics Project, now the Low Boom Supersonic Flight Demonstrator, which will provide data to prove that the loudness of a sonic boom can

be reduced and enable supersonic airliners to fly over land, which is not legal today."

**Don Taylor**, MS GGph, was elected to Titan Mining board of directors after receiving the Prospectors and Developers Association of Canada's 2018 Thayer Lindsley Award for the 2014 discovery of the Taylor lead-zinc-silver deposit in Arizona.

### 1986

**Richard Altice**, ChE, was named president and chief executive officer of NatureWorks.

### 1987

**Greg R. Vetter**, EE, was named associate dean for the University of Houston Law Center.

### 1991

**Eric Haynes**, Hist, completed his master's degree in urban education through Park University as part of the two-year Kansas City Teacher Residency Program to place highly qualified teachers in high-need urban schools. Haynes is teaching sixth-grade writing at KIPP: Endeavor Academy,

a K-8 public charter school in Kansas City.

### 1994

**Keith Esarey**, ME, has been promoted to president of McClure Engineering. He works as a mechanical engineer and principal of the firm and has served on the board of directors since 2009.

### 1995

**Randy Gorton**, CE, a 16-year veteran with BHC Rhodes, a Kansas City-area based civil engineering and surveying firm, was promoted to public works services group leader.

### 1996

**Brian Lasey**, ME, director of the physical plant in the Arkansas Tech University facilities management office, earned the Certified Educational Facilities Professional credential from the Association of Physical Plant Administrators.

### 1997

**Jonathan Robison**, CE, MS CE'03, principal

*Continued on page 40*



## HALL EARNS MATH ASSOCIATION AWARD

**Leon Hall**, Math'69, MS Math'71, PhD Math'74, former chair and professor emeritus of mathematics and statistics, earned the Missouri Section of the Mathematical Association of America's (MAA) Meritorious Service Award. A Missouri section member is eligible for this award once every five years. The award is presented for services rendered at the organization's national or section level. The MAA works to advance the understanding of mathematics and its impact on the world.

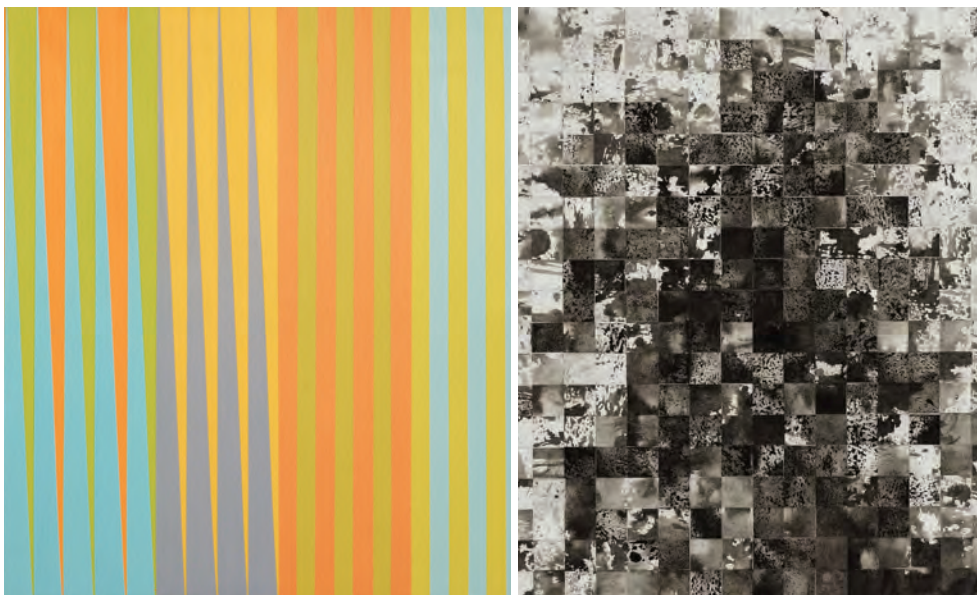

## ALUMNUS DONATES ARTWORK TO ST. LOUIS ART MUSEUM

**Ronald Ollie**, ME'73, and his wife, Monique, added depth and breadth to the Saint Louis Art Museum's holdings by providing 81 works by contemporary African-American artists.

Ollie's parents were frequent visitors to the museum and instilled in him and his siblings a deep appreciation of art. His childhood fascination with abstract art grew into a passion when, as an adult, he began to acquire abstract works by artists he admired and, often, befriended.

"My wife and I share the Saint Louis Art Museum's commitment of advancing knowledge while introducing art to people of all ages and backgrounds," said Ollie, who retired from a 30-year career in business development that included leadership positions at Fortune 500 firms and top architecture and engineering firms across the country. "The museum's collection helped ignite my passion — we are delighted to know works we have stewarded might do the same for future generations."

The Thelma and Bert Ollie Memorial Art Collection includes 81 paintings, drawings, prints, photographs and sculpture, including significant works by African-American artists.

The Ollies also gave an extensive collection of related resources — including a library of relevant books and an archive of ephemera and other research materials — that will support the study of the collection and provide a basis for future scholarship.



## ALUMNA PUBLISHES SECOND CHILDREN'S BOOK

**Sarah Boutte**, BSci'03, recently published her second children's book — this one focused on introducing STEM to young minds. Boutte says she was inspired to write books while working as a teacher to educate pilots on how to fly helicopters for the oil industry. With a busy career, she did not want to lose sight of her family priorities.

"As a teacher, making sure to get my message across is very important," says Boutte. "I think spiritual growth plays a big part in that, and when I had kids, I couldn't find many resources to help my children grow in that way. I want my kids to know and understand how much they are loved, especially when we are so busy in life, so I decided to write a book."

*Mama, Do You Know?* was released in March 2018. The book attempts to answer the hard-to-answer questions that toddlers often ask.

"Last summer my son asked me things like, 'Why don't sea turtles get cold when they are in water all the time?' or, 'Mama, do you love (my sibling) more than me?'" says Boutte. "A lot of parents clam up and freeze, and I tried to find a way to come up with explanations."

Boutte's first book, *Do You Know How Much Your Momma Loves You?*, was published in October 2017. (Photo courtesy of Michelle Robicheaux Photography)





Photo courtesy of Ron Jenkins



## VANDERSPIEGEL CHAMPIONS SWE INCLUSION EFFORTS

**Natalie Vanderspiegel**, CerE'02, MS EMgt'04, MS CerE'04, a past Miner Alumni Association awardee, director of diversity and inclusion for the Society of Women Engineers (SWE) and an employee of electricity generation company Solar Turbines, was featured in SWE's August edition of its "Live Out Loud" blog, a monthly post about practicing intentional inclusion.

In her post, Vanderspiegel tells how she came to the realization that she still considers herself a student. Especially when it comes to using the ideas behind diversity and inclusion to explore better ways to reach common goals through empathy and commitment to seek to understand diverse perspectives.

She says that SWE members are all students of intentional inclusion and that "the diversity and inclusion journey is one that never ends."

## LANDING A JOB AT MICROSOFT

The college selection process was a slam dunk for **Zach Ellis**, EMgt'16. He knew he wanted a place where he could grow academically and personally while continuing to play basketball, a sport he has loved since his youth.

"During the recruiting process, Coach **Jim Glash** sold me on attending Missouri S&T when we discussed how graduates of Missouri S&T graduate with multiple job offers and have great success in their respective fields," he says. "During a campus visit, Dr. **Stephen Raper** (EMgt'85, MS EMgt'87, PhD EMgt'89) helped me realize that engineering management would be a perfect fit, challenging me academically while helping me showcase my strengths."

Before graduating from Missouri S&T, Ellis completed internships as a project manager at The Boeing Co. in Seattle and Express Scripts in St. Louis. He also earned his Lean Six Sigma Green Belt certification. "Six Sigma" refers to the statistical analysis used when measuring process variation; "lean" methodology focuses on waste reduction and efficient work processes.

Now a consultant at Microsoft in Dallas, Ellis is part of a cross-functional team that provides continuous service improvements for everything from service strategies to operations.

"The curriculum for engineering management was a perfect fit for these opportunities," he says. "Missouri S&T put me in the perfect position to graduate and succeed!"

at GeoEngineers, was chosen by the American Society of Civil Engineers to lead the task committee creating a manual of practice about the trenchless method of direct pipe. The committee is comprised of engineers, contractors, and equipment manufacturers and suppliers from across North America and Europe.

1998

**Kevin McKenna**, MS EMgt, was appointed president and chief executive officer of Authentix, a leading global authentication and information services company.

2006

**Lynell Gilbert-Saunders**, PhD Chem,

an associate professor of chemistry at Missouri Southern State University, received the 2018 Governor's Award for Excellence in Education. The award is presented annually to an outstanding faculty member from each participating higher education institution in the state.

**Nicholas Villanueva**, Hist, was honored with the 2018 Faculty

Member of the Year Award from disability services at the University of Colorado, where he was recently promoted to assistant professor.

2009

**Stephanie Kline-Tissi**, GeoE, joined Jett Environmental Consulting in March 2018. The company specializes in groundwater

statistical analysis and environmental compliance consulting for solid waste management facilities.

**Eric Kopinski**, CE, joined the American Association of State Highway and Transportation's engineering department at the Washington, D.C., headquarters.

2010

**Brian Straus**, ChE: "After a brief career in industrial wastewater treatment, I followed the call to seminary and was ordained a Catholic priest in Springfield, Mo., on June 8, 2018."

2016

Missouri Gov. Mike Parson appointed

*Continued on page 43*



# ROCK-AND-ROLL GRANDPA EARNS PH.D.

He's driven the backroads with some of the biggest names in rock and roll, from Def Leppard and KISS to John Denver and the Eurythmics, hauling both gear and performers as a truck- and bus-driving roadie.

Yet despite his many brushes with fame, what gets **Mike Lusher**, CE'96, MS CE'04, PhD CE'18, most excited these days is his research into an unassuming desert shrub that some predict will revolutionize the rubber industry.

A fascination with the guayule (why-YOO-lee) plant that began a dozen years ago while watching an episode of the History channel show "Modern Marvels" culminated in a Ph.D. in civil engineering for the 64-year-old grandfather, who received his diploma last May.

"Along with being a source of rubber, this is a renewable, domestic source of binder-

modifiers for asphalt," Lusher says of guayule. The plant, native to northern Mexico and the southwestern U.S., is a source of resin that he and others envision as an eco-friendly alternative to petroleum-based additives used in asphalt pavement.

Such scientific insights were far from Lusher's mind while growing up as a music-obsessed teen in Union, Mo., he says. The drummer instead returned home from college to pursue his rock-and-roll dreams, touring regionally with several bands before deciding to settle down in the mid-1970s.

Starting with soul band the O'Jays in 1977, Lusher spent more than a decade on and off the road, driving for the likes of Jackson Browne, Kris Kristofferson, Rick James, and Southside Johnny and the Asbury Jukes. He returned to school in 1990, earning an associate's degree in engineering from East Central College in his hometown while in his mid-30s.

In school, the lure of the road persisted for Lusher, who spent some summers as a 40-something undergraduate hauling around groups like Boz Scaggs and Jimmy Buffett. Since 2005, he's worked full-time for S&T as a research specialist and lab manager under **David Richardson**, CE'71, MS CE'73, PhD CE'84, Chancellor's Professor of civil, architectural and environmental engineering and Lusher's advisor.

"When I first saw Mike in the classroom, he looked like a middle-aged truck driver — not your typical college student," Richardson recalls. "But it was quickly apparent that he was the smartest guy in the room. The type of research Mike was doing with guayule helped move our binder laboratory capability up several notches."



## BAILEY NAMED TO INGRAM'S 40 UNDER 40

**Dan Bailey**, GeoE'03, MS EMgt'05, a project manager for Cogent, was named to the Kansas City business magazine *Ingram's 40 Under 40* list for 2018. Bailey, a member of the S&T Order of the Golden Shillelagh and a vice president of the Miner Alumni Association board of directors, recently assisted in equipping the newly constructed Clayco Advanced Construction and Materials Laboratory at Missouri S&T.

Bailey started his career as an engineering project manager with Lee Mathews, an equipment supplier specializing in industrial pumps and other products. He currently serves as the company's director of engineering projects. Lee Mathews is one of nine partner companies that operate under Cogent.

## TRAP AND SKEET CLUB FUNDRAISES WITH ALUMNI

The St. Louis section of the Miner Alumni Association joined the S&T Trap and Skeet Club for the student organization's first fundraiser. Approximately 30 members of the club, alumni and friends each shot 25 skeet, 25 trap and 50 sporting clays. There were also merchandise sales and a raffle, which raised \$700 for the club. Club members hope to host the event again in 2019. Find the club on Facebook at Missouri S&T Trap and Skeet.



## WILLIAMS FEATURED ON CNN'S 'GREAT BIG STORY'

A video featuring **Dajae Williams**, EMgt'17, recently appeared on the cinematic storytelling website "Great Big Story." Williams' story focused on her work to ensure that young women are given the opportunities to pursue careers in STEM. She tells how she never saw anyone like her represented in the world of STEM while growing up.

Williams, a manufacturing engineer at NASA's Jet Propulsion Laboratory, rhymes and raps about math and science, making STEM fun and accessible for the next generation. Watch her story, titled "The NASA Engineer Making STEM Sing," at [rol.la/DajaeCNN](http://rol.la/DajaeCNN).

A graphic advertisement with a dark blue background and orange accents. The text reads: "BEST ENGINEERING PROGRAMS for Non-Traditional Students (Ranked No. 2, College Factual 2018)". Below this, it says "CERTIFICATES | MASTERS | DOCTORATES". At the bottom left is the "S&T" logo. At the bottom right, it says "Spring Classes Start - JAN. 22" and "distance.mst.edu" with an arrow pointing to the website.

**BEST** ENGINEERING PROGRAMS  
for Non-Traditional Students  
*(Ranked No. 2, College Factual 2018)*

CERTIFICATES | MASTERS | DOCTORATES

**S&T** Spring Classes Start - **JAN. 22**  
[distance.mst.edu](http://distance.mst.edu)

**Avery Welker**, PetE, a graduate student in petroleum engineering from Perryville, Mo., to serve as the student representative to the University of Missouri Board of Curators. He has held internships with Devon Energy in Oklahoma City, where he was a reservoir engineering intern, and with TG Missouri in Perryville, where he worked in the chrome plating division.

2017

**Matt Dorsey**, ChE, was awarded the Congress-Bundestag Fellowship to study and work for one year in Germany. While in Germany, he will attend a two-month intensive German language course, study at a German university or professional school for four months, and complete a five-month internship with a German company in his career field.

**Nathan Monzyk**, CE, joined Byrne & Jones Construction's micro surfacing division as a project manager and estimator. Byrne & Jones is a diversified St. Louis civil site contractor serving clients in concrete, sports, asphalt, soil stabilization, marine and micro surfacing.

**Owen Smith**, Phys, received a Fulbright scholarship grant to study in Russia from the J. William Fulbright Foreign Scholarship Board. Smith is an English-language teaching assistant at a Russian university for the academic year from September 2018 to June 2019. □

# FUTURE MINERS



1. **Nick Adams**, MinE'10, and his wife, **Kathryn (Hendricks) Adams**, EMgt'14, had a boy, Gunnar Breck, on March 3, 2018.
2. **David Clemenson**, NucE'14, and his wife, **Emma Clemenson**, Hist'11, had a girl, Freya Evelyn, on Dec. 30, 2017.
3. **Lindsey Dunstedter**, TComm'09, and her husband, Daniel, had a boy, Henry Daniel, on Feb. 9, 2018. He joins big sisters Anna, 10, Emme, 6, and Nora, 3.
4. **Gary Graham**, CE'96, and his wife, **Melissa (Kuenzel) Graham**, ChE'94, had a girl, Margaret, on June 30, 2016. She joins siblings Alex (a current S&T student, holding Margaret), Allison, Nicholas, Peter, Clare and Sara.
5. **Shawn Meeks**, ME'13, and his wife, **Sara (Shafer) Meeks**, ArchE'11, MBA'12, had a boy, Roman Nikola, on March 29, 2018. He joins brother Abel.





**Rebecca Molt**, a junior in ceramic engineering from Camdenton, Mo., joins a group of students writing thank-you notes to their scholarship donors in Hasselmann Alumni House.

# POSTMARK GRATITUDE

Every semester since fall 2014, the students who receive endowed scholarships at Missouri S&T have done something “old fashioned” in the Instagram age — they’ve picked up pen and paper and written thank-you notes to their donors. This fall, more than 1,100 students joined in.

During the first week of classes every semester, scholarship students visit Hasselmann Alumni House to participate in Postmark Gratitude, a letter-writing marathon designed to highlight the partnership that students share with their

scholarship donors, and connect students and their benefactors in a meaningful way.

“The act of writing a thank-you note — and the reciprocal act of receiving it — creates a one-to-one connection that is powerful in its simplicity and profound in its impact,” says **Joan Nesbitt**,

vice chancellor for University Advancement. “The feedback we receive from donors is exceptionally positive. But what is equally gratifying is the fact that so many students say they appreciate the opportunity to communicate with their donors.”

For **Steve Rector**, PetE’72, MS PetE’73, a first-generation college graduate who came to S&T on a scholarship, giving back is important. Rector and his wife, **Susan**, receive approximately 30 thank-you notes every year from students supported by the Stephen and Susan Rector Petroleum Engineering Endowed Scholarship.

“We read every one of those cards,” says Rector, president of the Miner Alumni Association board of directors. “It’s always a delight to learn about the students who hold our scholarships. Many S&T students are first-generation college students like I was. I owe my career success to the scholarship I held for four years.”

# MINERS REMEMBERED

Missouri S&T Magazine will announce deaths when information is submitted by an immediate family member or published in a newspaper obituary. Notification of deaths that have occurred more than two years before the date of publication will not be published unless a special request is made by a family member. Yearbook photos, if available, will be included for alumni when families submit obituary information. Due to the production time required for each issue, submissions may take up to six months to appear. Your patience is appreciated.

**James A. Martin,**  
GGph (April 16, 2018)

## 1957

**Robert L. Dugan,**  
CE (May 12, 2018)

**Robert G. Nutter,**  
EE (July 22, 2017)

## 1958

**Robert F. Campbell,**  
NDD (April 2, 2018)

**George T. Ritter,** ME  
(May 28, 2018)

**Leman C. Schruppf,**  
ME, was a member of Independents, Geeks for God and Army ROTC. (Jan. 15, 2017)

## 1959

**S. Fred Isaacs,** EE  
(May 11, 2018)

## 1960



**Gerald A. Fink,** CE, was a member of Chi Epsilon Fraternity and Army ROTC. Mr. Fink participated in the American Society of Civil Engineers, Tech Engine Club, Independents and Honors Association. He worked for the U.S. Forest Service, the Illinois Department of Transportation and Southern Illinois University. (Dec. 20, 2017)

**Robert N. Henkel,**  
ME (Feb. 28, 2018)

**J. Paul Kemper,** MinE,  
MetE (Feb. 23, 2018)

Alumni Association, Mr. Edwards was also active in the Jackling Jocks, a group of alumni who are former Missouri S&T athletes. (May 6, 2018)

## 1954



**Herbert E. Lincoln III,** CE, was a member of Sigma Nu Fraternity and Blue Key. Mr. Lincoln was an avid sailor, cyclist, handball player and tennis player. He was a master woodworker, boat builder, toymaker and artist. (April 3, 2018)

**B. Thomas Wykoff,**  
ME (March 1, 2018)

## 1955

**Elmer L. Luehring,**  
EE (Dec. 23, 2017)

## 1956

**Larry N. Fussell,** ChE  
(April 30, 2018)

## 1939

**Donald D. Burris,**  
MinE (May 28, 2016)

## 1942

**Niles Brill,** MinE  
(April 13, 2018)

## 1946

**Arthur R. Meenen,**  
CE (April 25, 2018)

## 1948

**Peter F. Bermel,** CE  
(Oct. 21, 2017)

**Max L. Kasten,** ChE  
(May 23, 2018)

## 1949

**Robert C. Hansen,**  
EE (Feb. 9, 2018)

**John Hegwer,** PetE  
(Dec. 11, 2016)

**Henry J. Hellrich,**  
EE (April 17, 2018)

## 1950

**Morton Deutch,** MetE  
(June 15, 2018)



**David C. Grimm,** MetE, was a member of Pi Kappa Alpha Fraternity and Blue Key. Mr. Grimm was a basketball athlete. He served in the Navy during World War II and earned an MBA from Saint Louis University in 1953. He worked as a metallurgical engineer in St. Louis at McDonnell Aircraft Corp. until moving to New England in 1964. In 2005, he was inducted into the S&T Academy of Mines and Metallurgy. (May 7, 2018)

**William B. Heisler,**  
ChE (March 1, 2018)



**Frank A. Soukup,** MetE, was a U.S. Navy veteran of World War II and a member of the

PVB Mariner Marlin Association. Mr. Soukup was a metallurgical engineer for Bullard's in Bridgeport for 30 years. (Aug. 9, 2013)

**Dale E. Walker,** CE  
(May 25, 2018)

## 1951

**Kon-Hock Khaw,**  
MS MinE, was a member of AIME. (April 1, 2013)

**Robert L. Kronmueller,**  
ME (Feb. 13, 2018)

**Samuel Shaw III,**  
MinE (Jan. 6, 2017)

## 1952

**Ralph H. Lilienkamp,**  
MS Phys (May 7, 2018)

**Everett Stevens,** CerE  
(Aug. 21, 2016)



**Waldemar D. Stopkey,** CE, was a member of Chi Epsilon Fraternity, Tau Beta Pi and Independents. Mr. Stopkey earned a master's degree in

structural engineering from Illinois Institute of Technology in 1958. He began working for Procter & Gamble in 1952 and joined Union Carbide in 1963. He retired as senior vice president of administration from Walk, Haydel and Associates in New Orleans in 1996. He received a direct commission into the Navy Reserves Civil Engineering Corps in 1956 and retired in 1982 as commander. (April 10, 2018)

**Robert O. Wickey,**  
ChE (June 5, 2018)

## 1953

**Wayne C. Dannenbrink,**  
CE (March 8, 2018)



**Gene W. Edwards,** CE, was a member of Triangle Fraternity and Army ROTC, played basketball and ran track for the Miners. An active member of the Miner



# IN MEMORIAM

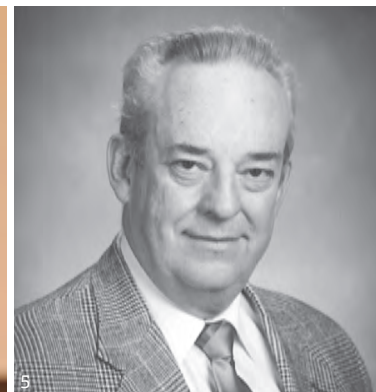
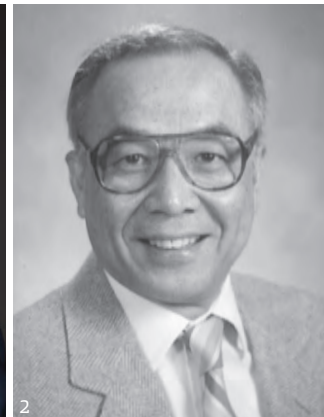

1. Dr. **Ju-Chang "Howard" Huang**, professor emeritus of civil engineering and former director of the Environmental Research Center, died on Jan. 16, 2018, in Hong Kong. Dr. Huang joined the Missouri S&T faculty in 1967 and served until 1992. In 1993, he joined Hong Kong University of Science and Technology to help develop its environmental engineering program. He was a professor and researcher there until his retirement in 2006. Dr. Huang held a bachelor of science degree in civil engineering from the National Taiwan University and master of science and Ph.D. degrees in environmental health engineering from the University of Texas at Austin. He was an expert in wastewater cleanup and treatment and was a founding member of the Overseas Chinese Environmental Engineers and Scientists Association.
2. Dr. **Shen Ching Lee**, professor emeritus of mechanical engineering at Missouri S&T, died on May 30, 2018. Dr. Lee was born in Penglai City, Shandong, China, then moved to Taiwan after the Japanese invasion. He earned a bachelor of science degree in mechanical engineering from the National Taiwan University, a master of science degree from Illinois Institute of Technology and a Ph.D. from the University of Washington in Seattle. He worked for Perfex Plastic Inc. in Chicago and then for Boeing 1957–66. In 1966, he joined the University of Tennessee Space Institute faculty before joining the Missouri S&T faculty in 1967. He retired as professor emeritus in 2001.

3. Dr. **Russell D. Buhite**, professor emeritus of history and political science and former dean of the College of Arts and Sciences at Missouri S&T, died on May 27, 2018. He was 79. A noted scholar in U.S. diplomatic history, he was the author of 12 books, one of which was nominated for the Pulitzer Prize in Letters. Before he became an author and a history professor, Dr. Buhite was a minor league first baseman and outfielder for the New York Giants, the Baltimore Orioles and the Washington Senators. His experiences informed his book, *The Continental League*. Dr. Buhite joined Missouri S&T as dean of the College of Arts and Sciences in 1997 and held that position until 2002. Prior to joining the Missouri S&T faculty, Dr. Buhite taught for 25 years at the University of Oklahoma, serving 10 years as chair of the history department, and was head of the history department at the University of Tennessee.
4. Dr. **Charles Alvin Wentz Jr.**, ChE'57, MS ChE'59, died on June 21, 2018. He earned a Ph.D. in chemical engineering from Northwestern University after graduating from S&T and was employed by Phillips Petroleum, the University of North Dakota and Argonne National Laboratory. Dr. Wentz served as president of New Park Waste Treatment Systems, Wentz Healthcare and International Scientific Management, and ENS Co. Dr. Wentz held patents in the chemical and polymer fields and published numerous technical and business papers. He authored college textbooks

- in environmental and safety engineering and was a visiting professor at Southern Illinois University in Edwardsville and associate dean at Chulalongkorn University in Bangkok, Thailand. He was an avid cook and published a cookbook. A member of the Missouri S&T Academy of Chemical Engineers and the S&T Alpha Kappa Educational Foundation, he was active in Pi Kappa Alpha as well as in numerous civic and professional organizations. He established many college and vocational scholarships at Edwardsville High School, Missouri S&T, area churches and East St. Louis High School.
5. Dr. **Madison McDonald "Mack" Daily**, PhD EMgt'84, professor emeritus of engineering management, died on July 22, 2018. Missouri S&T's engineering management department awarded its first Ph.D. to Dr. Daily. He joined S&T's faculty following graduation and retired in 1999. During his tenure at S&T, Dr. Daily helped set the foundation for online courses and distance learning at S&T. He championed using the most advanced technology available at the time, starting with satellites and then moving to computer and video technology. Dr. Daily also taught classes through the National Technological University, a consortium of 45 universities. Prior to joining S&T, Dr. Daily earned a bachelor's degree from the U.S. Naval Academy in 1954 and a master's degree from the Air Force Institute of Technology in 1958. He served 25 years in the Air Force before retiring as a colonel in 1979.

## 1961

**John Hustad, EE**  
(June 7, 2017)

**Jack R. Long, MetE**  
(May 14, 2018)

**Fred H. Marshall, ME**  
(March 29, 2018)

**Ernest B. Perry Jr., CE**  
(Feb. 19, 2018)

**Richard B. Spieldoch, CE**  
(Feb. 4, 2017)

**James A. Stidham, CE**  
(April 27, 2018)

## 1962

**Rufus D. Johnson, ChE**  
(Jan. 28, 2017)

**Boyd Miller, NDD**  
(March 14, 2018)

**Marvin L. Wolfenbarger, EE**  
(March 8, 2018)

## 1963

**Donald W.C. Frierdich, ME**  
(Jan. 28, 2018)

**Troyce D. Jones, MS Math**  
(March 28, 2018)

**George Krieger, ME**  
(May 8, 2018)

## 1965

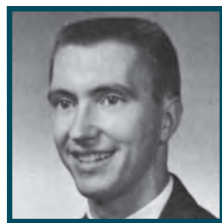

**Danny L. Chilton, CE**, was a member of the Independents and the American Society of Civil Engineers. Mr. Chilton worked for the Illinois Department

of Transportation and as a consulting engineer and led WVP Corp. to its merger with URS. He retired after being diagnosed with Parkinson's disease in 2004. He and his wife, Suzanne, wrote *Blue & Gray Cross Current* based on family memoirs and official records of the Civil War in the Ozarks. (June 18, 2018)

**Robert L. Kettelkamp, EE**  
(April 28, 2018)

**Glenn L. Osick, CE**  
(April 9, 2018)

**Harold R. Rochester, EE**  
(June 13, 2016)

## 1966

**Donald E. Watke, EE, MS EE'68**, was a member of the Independents, Tau Beta Pi and Phi Kappa Phi. (April 12, 2018)

## 1967

**Cleo F. Aebel Jr., EE**  
(Jan. 14, 2017)



**Garry S. Brown, EE**, was a member of Tau Beta Pi and Phi Kappa Phi. Mr. Brown earned a master's degree from the University of New Mexico and spent his career at Sandia National Laboratories. A lifelong student of history, he pursued genealogical research. (April 30, 2018)

**Ronald E. Evans, CE**  
(Feb. 26, 2018)

## 1968

**James W. Bortmess, CE**  
(Dec. 28, 2017)

**Robert S. Hawkins II, EE**  
(May 9, 2018)

## 1969

**Joseph Davis, MS CE**, served in the U.S. Army and worked as a civil engineer for NASA at the Kennedy Space Center for 30 years. (Aug. 24, 2017)



**Douglas R. Williams, ME**, was part owner and operator of Bonnie View Golf course in Eaton Rapids, Ohio, for 35 years. Mr. Williams retired from Oldsmobile after 29 years. He enjoyed golf and restoring cars. (July 18, 2016)

## 1970

**Charles B. Gaston, MinE**  
(March 20, 2018)

**Anthony Novembre, Psych**  
(Oct. 1, 2017)

**John O'Brien, EMgt**  
(Oct. 13, 2017)

## 1973

**David P. Owsley, MS EE**  
(March 6, 2018)

## 1974

**Phillip W. Inman, Hist**  
(Dec. 25, 2017)

## 1975

**James R. Fleming, CSci**, was a member of the *Rollamo* staff, Tech Engine Club and Phi Kappa Phi. (Feb. 25, 2018)

**William Peach, NDD Econ**  
(March 12, 2018)

## 1976

**William P. Donovan, MS MetE**  
(March 14, 2018)

**Gary A. Schaeffer, ChE**  
(March 23, 2018)

## 1977

**Patrick J. Cody, ME**  
(April 10, 2018)

## 1979

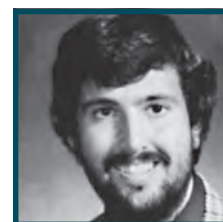

**Robert W. Fleming, Econ, EMgt'82**, was in the band and was a member of the Tech Engine Club, the Economics Club and intramurals. (Nov. 26, 2017)

**Ronald H. Jansen, EE**  
(March 8, 2018)

## 1981

**Eric Schramm, CerE**  
(April 12, 2018)

## 1985

**Scott Richard Ernst, EE**  
(April 20, 2018)

**Scott White, ME**  
(May 28, 2018)

## 1986

**Fereidoun Shokouhi, MinE**  
(April 28, 2018)

## 1994

**Edward Hohlt Sr., Econ**  
(April 24, 2018)

## 1999

**Megan McDonough, MetE**  
(June 11, 2018)

## 2016

**Vincent A. Harris, ME**  
(Aug. 27, 2017)

## FRIENDS

**Donald Z. Barklage**  
(March 27, 2018)

**Oscar S. Beckham**  
(May 9, 2018)

**Nadyne Bender**, wife of the late John Bender, CerE'53 (Dec. 25, 2016)

**Howard E. Boyer**, former S&T student (May 13, 2018)

**Ellanore Breit**  
(Sept. 7, 2016)

**Richard Bullock**, retired S&T physical facilities staff member (Dec. 14, 2017)

**Marian Clark**, wife of Kenneth K. Clark (Nov. 16, 2017)

**Juanita Collier**  
(April 9, 2018)

**Lloyd Miller Cross**, former S&T staff member (June 24, 2018)

**William Green**, former S&T student (Nov. 1, 2016)

**William W. Hoertel**  
(March 5, 2018)

**Patricia Kinhead**, former S&T student (April 7, 2018)

**Lucille M. Korsmeyer**  
(Feb. 4, 2018)

**Sharon L. Lang**, wife of Gregory A. Lang, MinE'78 (Feb. 23, 2018)

**Elsie R. Leake**  
(May 23, 2018)

**Kevin Light**, former S&T student (June 2, 2018)

**Doris Packheiser**, wife of Elmer D. Packheiser, ME'51 (Feb. 14, 2018)

**Albert T. Padovano**  
(March 16, 2018)

**Lois Purdy**, wife of the late George E. Purdy, ChE'47 (Oct. 27, 2017)

**Wanda Pyeatt**  
(April 6, 2018)

**Norma Schneider**, wife of the late Donald Schneider, Chem'54 (Jan. 27, 2018)

**Lorraine Settgas**, wife of the late Robert Settgas, ME'50 (Sept. 21, 2018)

**Kay Vietti**, wife of the late Michael Vietti, Phys'72 (April 9, 2018)

**Heidi Wallace**  
(March 25, 2018)

**N. Weinrich**  
(March 1, 2018)

**Helen White**, former S&T staff member (May 8, 2018) □



Tom, Bob and Steve Sieckhaus.  
Photo by August Jennewein.

# KEEPING CIVIL IN THE FAMILY: BOB, STEVE AND TOM SIECKHAUS



It's no surprise that **Steve Sieckhaus**, CE'87, MS EMgt'94, and **Tom Sieckhaus**, CE'88, both became civil engineers — or that both earned degrees at S&T. After all, they're the sons of Miner and civil engineer **Bob Sieckhaus**, CE'63.

"I never considered anything but civil," says Steve, chief operating officer and shareholder of Clayco Inc., one of the nation's largest privately owned real estate and design-build firms. "I remember watching my dad work most evenings at the kitchen table estimating projects. He took us on site visits. My passion for construction was fueled by those visits."

Tom, Clayco executive vice president and shareholder, shares similar memories. "My father exposed me to industrial job sites growing up, and that fostered my interest in construction," he says. "I never really considered a different major. Dad was passionate about Rolla and pushed me hard in that direction."

Like the sons he mentored, Bob, who retired from the Murphy Co. after a 40-year career, credits civil engineers with inspiring his passion for the profession. As a 17-year-old Army recruit at Fort Leonard Wood, Bob joined the 18th Engineering Brigade.

"I was quartered with a bunch of college graduates who were civil engineers," says Bob. "They took me under their wing. After that, I pretty well knew I wanted to be a civil engineer. Logging many miles on old Route 66 (between St. Louis and Fort Leonard Wood), I always noticed the Missouri School of Mines signs in Rolla. I took this as a sign that was where I needed to be."

The Sieckhauses have been making trips from St. Louis to Rolla ever since. All three are members of the Academy of Civil Engineers and return to campus for meetings. In April 2018, they were recognized by the academy for

their philanthropic leadership in supporting a major S&T project, the Clayco Advanced Construction and Materials Laboratory, with a \$2 million donation from Clayco. The new lab marks the final phase of a \$10.5 million initiative to strengthen S&T's leadership in infrastructure engineering.

"Clayco was pleased to make a major investment in this project," says Steve. "Many of our construction professionals are civil engineers who graduated from Missouri S&T. We have benefited as a company from the great education the university provides."

"We believe the lab will be a difference-maker for the university," says Tom. "And the research conducted there will affect the daily lives of millions for generations to come."





## CELEBRATION OF NATIONS

This Chinese dragon, carried by S&T students from China, was just one entry in the 10-block procession that formed the 2018 Parade of Nations, the kick-off event in S&T's ninth annual Celebration of Nations. The celebration, which showcases the cultural diversity found in the Rolla community, features cultural performances and international food, among other entertainment. Photo by Terry Barner.





Miner Alumni Association  
1100 N. Pine St.  
Rolla, MO 65409-0650

**CHANGE SERVICE REQUESTED**

*Parents: If this issue of Missouri S&T Magazine is addressed to your son or daughter who has established a separate permanent address, please notify us of the new address: 800-10-MINER or alumni@mst.edu.*

Nonprofit Org.  
U.S. Postage Paid  
Liberty, MO  
Permit #143

A PUBLICATION OF THE  
MINER ALUMNI ASSOCIATION  
REPRESENTING AND SERVING  
ALUMNI OF MSM, UMR AND  
MISSOURI S&T

**MENTORS, LEADERS,  
GUIDES**

FALL/WINTER 2018  
VOL. 92 NO. 3  
MAGAZINE.MST.EDU



# WITH GRATITUDE TO OUR ALUMNI AND FRIENDS

Thank you for the great gift of your support. This past fiscal year, Missouri S&T was honored to receive charitable gifts and pledges of more than \$22.6 million — the second-largest fundraising year in our history. From labs and learning centers to scholarships and student athletics, your partnership made it a milestone year for Miner pride.

