

1-1-2005

Gamma-Ray Induced Photoconductivity in Pyrex, Quartz, and Vycor

Shoaib Usman

Missouri University of Science and Technology, usmans@mst.edu

Lubna Shoaib

James N. Anno

Follow this and additional works at: http://scholarsmine.mst.edu/min_nuceng_facwork



Part of the [Nuclear Engineering Commons](#)

Recommended Citation

S. Usman et al., "Gamma-Ray Induced Photoconductivity in Pyrex, Quartz, and Vycor," *IEEE Transactions on Nuclear Science*, Institute of Electrical and Electronics Engineers (IEEE), Jan 2005.

The definitive version is available at <https://doi.org/10.1109/TNS.2005.861419>

This Article - Journal is brought to you for free and open access by Scholars' Mine. It has been accepted for inclusion in Mining and Nuclear Engineering Faculty Research & Creative Works by an authorized administrator of Scholars' Mine. This work is protected by U. S. Copyright Law. Unauthorized use including reproduction for redistribution requires the permission of the copyright holder. For more information, please contact scholarsmine@mst.edu.

Gamma-Ray Induced Photoconductivity in Pyrex, Quartz, and Vycor

Shoaib Usman, Lubna Shoaib, and James N. Anno

Abstract—Results of an experimental investigation are reported on photoconductive response of Pyrex, Quartz and Vycor. This research was conducted as a feasibility study for developing a new gamma dose measurement device based on the principle of photoconductivity. However, data collected in this study are equally valuable for various other applications where these materials are to be used in high radiation field. Our experiments and analyzes indicated that the selected dosimeter materials exhibit photoconductivity and respond to changes in gamma dose rate within a useful range. Pyrex glass suffered radiation damage at a relatively high dose rate of 0.25 Gys^{-1} . Quartz and Vycor exhibit significant advantages over Pyrex as dosimeter material. However, their limit of operability was found to be at a dose rate of approximately 28 mGy s^{-1} . Vycor dosimeter in particular appears promising for gamma measurement applications. From an endurance point of view, Quartz appears to be the most suitable material for applications in high dose rate conditions, in that photo-currents in Quartz were observed to be minimum.

Index Terms—Biomedical applications of radiation, gamma-ray effects, photoconductivity, substrates materials.

I. INTRODUCTION

THIS paper reports the observed effect of photoconductivity in three commonly used materials, i.e., Pyrex, Quartz, and Vycor. Experimental results presented in this paper may be useful for researchers using these or similar materials in high radiation fields.

Use of high intensity radiation in various industrial and medical applications has increased rapidly in the recent years. Therefore, there is a need for better understanding the effects of radiation on various materials directly exposed to gamma radiation or X-rays. Pacific Northwest National Laboratory (PNNL) has conducted an extensive study to develop fundamental understanding of radiation effects in glasses and ceramics. This effort resulted in numerous publications cited by Weber in his final report [1]. Other investigators have reported effects of gamma radiation on materials. For example, dimensional changes in glass induced by gamma were studied by Allred [2]. McIlvaine [3] investigated effect of gamma radiation on tensile strength and impact characteristics of glasses. Likewise, radiation induced discoloration is also reported in the literature [4], [5].

Doweidar and co-workers [6] investigated other physical and mechanical effects induced by gamma radiation in glasses, including; hardness, density changes, and infrared spectra shift. All these changes are very significant for various applications including medical and pharmaceutical uses, micro-electro-mechanical (MEMS) devices and imaging.

Photoconductivity in various materials has been an area of significant interest [7]–[9]. Investigators have reported various aspects of the phenomenon. In this paper, we report our observation on gamma induced photoconductivity in bulk materials at very high dose rates. The purpose of this study is two folds. First of all, we wanted to measure the gamma induced currents in Pyrex, Quartz and Vycor, as these materials are being used in MEMS, Active Matrix Flat-Panel Imagers (AMFPI's) and other applications as structure and substrates. Secondly, if the phenomenon is significant and linear in dose rate, we wanted to investigate the feasibility of a dosimeter based on gamma induced photo-currents. An objective of this research was to study the feasibility of developing a high intensity dosimeter using gamma-induced photoconductivity.

Unsatisfactory performance of the existing devices for high dose rate applications, have given rise to the need for a better gamma measurement system. The single most important factor limiting the lifetime and operability of such devices is the radiation environment they encounter [10]. Three materials studied in this research are known to have high radiation tolerance. Moreover, use of Pyrex, Quartz and Vycor as insulator and/or substrate in high radiation environment has necessitated a need for better understanding the photoconductive response of these materials. We investigated this response by irradiating the sample material in Co-60 gamma field at Winkel Radiation Laboratory at the University of Cincinnati. For the dose rates studied, photo-current was observed to be in the range of nano-Amperes (nA) to micro-Amperes (μA). These results demonstrated validity and applicability of the concept. Moreover, data collected in this study is valuable for other application involving exposure of these materials to high radiation fields and voltage potential.

II. PHENOMENON OF PHOTOCONDUCTIVITY

Phenomenon of photoconductivity has been known for well over half a century [11]. It is well known [12]–[16] that photoconductivity (under steady state conditions) is related to the (photon) dose rate. In fact, the observations show that photoconductivity increases as the dose rate increases and that the governing [12] expression is

$$\sigma_p = kD^x. \quad (1)$$

Manuscript received August 15, 2005; revised December 21, 2005.

Shoaib Usman was with University of Cincinnati, Cincinnati, OH 45220 USA. He is now with the University of Missouri-Rolla, Rolla, MO 65409 USA (e-mail: usmans@umr.edu).

L. Shoaib was with University of Cincinnati, Cincinnati, OH 45220 USA. She is now with Yathrib Associates Cincinnati, OH 45069 USA.

J. N. Anno, deceased, was with University of Cincinnati, Cincinnati, OH 45220 USA.

Digital Object Identifier 10.1109/TNS.2005.861419

where σ_p is the photoconductivity, k is the proportionality constant, and D is the dose rate. Traditionally, the value of x is known to range [13] from 0.5 to 1.0 depending upon the dose rate and the material properties. For low dose rate and for high impurity material (impurities give rise to traps and hence influence gamma induced photoconductivity) the value of x approaches unity and the photoconductivity therefore becomes directly proportional to the dose rate.

Using this law of photoconductivity one can measure the dose rate by measuring the current, and the total dose (integrated dose) by measuring the integrated current. Electrical resistance may be written as

$$R = \frac{C}{\sigma_t} \quad (2)$$

where R is the electric resistance, C is the geometry constant and σ_t is the total conductivity. The total conductivity is the sum of the dark or "out-of-pile" conductivity (σ_d) and the photoconductivity (σ_p)

$$\sigma_t = \sigma_p + \sigma_d. \quad (3)$$

It is important to note that σ_d should be as small as possible to enhance the relative response of the material to photons. In other words, photoconductivity (σ_p) should be the dominant part of the total conductivity. For a material with very low σ_d resistance is approximated by

$$R = \frac{C}{\sigma_p + \sigma_d} = \frac{C}{\sigma_p} \quad (4)$$

Therefore, current can be written as

$$I = \frac{V}{R} = \frac{V}{C/\sigma_p} = \frac{V\sigma_p}{C}. \quad (5)$$

This means the current can be a direct measure of photoconductivity and can therefore be used to measure the dose rate to which the material is exposed, once the constants in (1) have been determined. Photoconductivity is dependent on the electron mobility and the density of the photon-induced free electrons as [12]

$$\sigma_p = \mu en \quad (6)$$

where μ , electron mobility, e , electron charge, and n , the density of photoelectron. The time dependence of the density of photoelectron is known to be given approximately by the expression

$$\frac{dn(t)}{dt} = P - An^2(t) - BNn(t). \quad (7)$$

In this expression $An^2(t)$ is the recombination term and $BNn(t)$ is the trapping term, where N is the number of impurities per unit volume. For a high impurity substance A should be small relative to B and hence the steady state result can be written as

$$n_\infty = \frac{P}{BN} \quad (8)$$

where n_∞ is saturation electron density, P , is the production term and BN , is the constant for trapping. In order to have high photoconductivity there must be a high photoelectron production rate (i.e., large photon cross section for electron ejection). Therefore, in addition to the high impurities (for linear re-

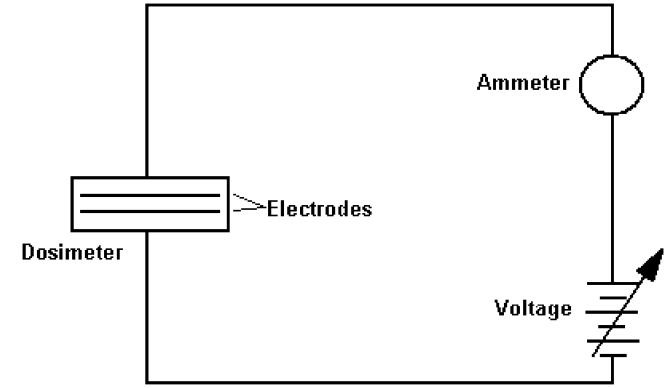

Fig. 1. Schematic diagram of the detector circuit.

sponse), the detector material should also have large cross section for (γ, e^-) reaction. Incorporating the foregoing expressions in (5) we have

$$I = \frac{V}{C} \mu e \frac{P}{BN}. \quad (9)$$

All the terms in the above expression are constant (material and/or geometry specific), therefore at steady state the current at a constant voltage is proportional to the production rate of the electrons. After proper calibration it seems feasible to measure gamma dose rate by recording photo-currents. It is interesting to note that as long as one can appropriately calibrate the electronics, the linear relationship (i.e., high impurity in the materials) between dose rate and photoconductivity (although desirable) is not necessary.

III. MATERIALS AND METHODS

A. Geometry

Emphasis was placed on simplicity of the dosimeter design and circuitry, as is shown in Fig. 1, circular disc geometry was selected in order to minimize the surface and bulk emission effects. It was found necessary that the electrodes be embedded in the dosimeter material or otherwise electrically shielded, to avoid stray ionization and electron emission currents from the outer electrode surfaces. For this study, bulk material was preferred over very fine layer to reproduce substrates geometry. Specific dimensions are discussed in the following section.

B. Electronic Circuit

For research purposes the dosimeter has been developed as the photoconductive sensor connected in series with a pico-ammeter and a variable power source (Fig. 1). Neither of the latter two components is expected to be included in a practical dosimeter application. Rather, a fixed voltage source and a direct readout circuit, using micro-processors, responding directly to the output current from the sensor would be used. A current mode operation rather than a pulse mode operation is tested in this study. This choice is due to two reasons. Firstly, at the intended high dose rates, pulse mode operation of any detection system is not feasible [17], [18]. Secondly, we wanted to measure leakage current from the substrates made from these materials. For this purpose current mode measurements are more appropriate. Keithley 485 (Serial no. 0547183) pico-ammeter

was used for current measurements. Current measurement uncertainty using Keithley 485 model ammeter is less than 0.5%. Therefore, these small uncertainties are not shown in the results.

C. Material Selection

It is known that one effect of gamma radiation is to decrease the electrical resistivity of materials [12]–[14]. Based on the comparison of the relative radiation endurance of insulating materials and capacitors [12] to permanent effects, a special Pyrex glass, Quartz and Vycor were chosen as the initial choices for sample dosimeter base materials. This selection was based on their relatively high radiation damage threshold dose.

Pyrex glass (Lithia Potash Borosilicate-Corning #7070, mesh #325) in powder form (U.S. standard mesh size of 4 through 25) was used as the first material for dosimeter. It had a lower softening point ($\sim 1000^\circ\text{C}$) than Quartz ($\sim 1800^\circ\text{C}$), therefore it was more workable. Discs shaped dosimeters were fabricated from Pyrex. Quartz (Spectrosil A), the highest grade of TSL synthetic silica, with SiO_2 content $>99.9\%$ (supplied by Quartz Product Company, Louisville, KY) was used as the second dosimeter. Semi-conductor grade Quartz (VITREOSIL OSC) discs (diameter = 5.08 cm, thickness = 0.63 cm) were used. Vycor (Glass Code 7913) was selected as the third base material. This selection was based on the observation that Pyrex dosimeters (with high impurity) produce photoconductive currents of significantly high magnitude while Quartz (high purity material) produces photoconductive currents of low magnitude. Hence, it was deduced that by using a base material with moderate level of impurities the current would be in a more useful range. Vycor has a SiO_2 content of approximately 96%. Vycor discs (5.08 cm in diameter and 0.63 cm in thickness) were obtained from Cincinnati Gasket. Electrodes were painted on the polyurethane (used as the insulation) for both Vycor and Quartz sample. Detail material specifications are reported by Shoab [19].

D. Gamma Source Description

The Cobalt Radiation Facility (Winkel Radiation Laboratory), at the University of Cincinnati was used for sample irradiations. This extensively calibrated source consists of eighteen Cobalt-60 pins in a cylindrical-ring array. Various exposure rates are possible by using various source pin combinations and different irradiation chambers. For this project, in all the exposures the sample was placed in a cylindrical aluminum chamber 16.7 cm in diameter and 57.2 cm high and lowered into the source. The exposure dose rate was altered by changing the height of the sample within the chamber. The maximum dose rate possible using this arrangement was approximately 0.32 Gys^{-1} .

Using the 18 pin configuration of the gamma source, the Pyrex sensor was exposed to different gamma dose rates. A high voltage power supply was used, and at each dose rate the voltage was varied from 0 Volts to 350 Volts, in steps of 50 or 70 V. Data were collected for the three materials at each voltage for about twenty minutes. This procedure was repeated for different dose rates. Using the data obtained from the sample dosimeters irradiation, current-time and current-voltage curves were obtained.

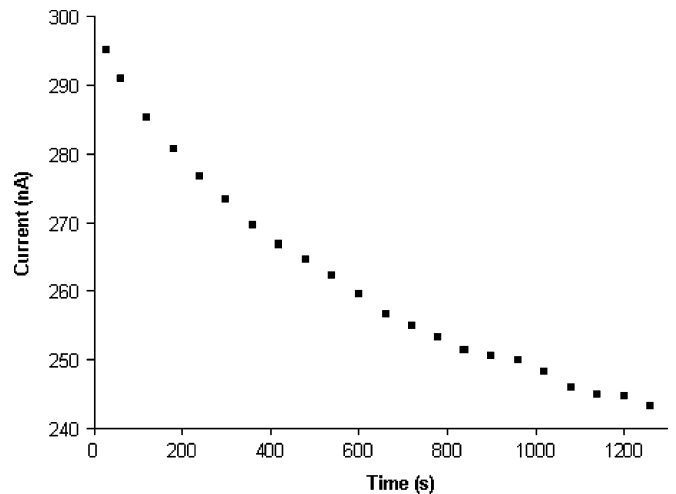

Fig. 2. Pyrex transient response of photocurrent at 0.15 Gys^{-1} .

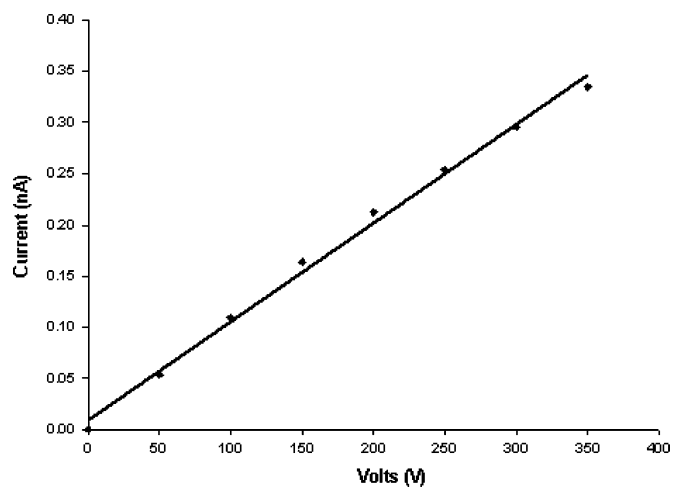

Fig. 3. Pyrex current voltage relationship at 0.1 Gys^{-1} .

IV. RESULTS

A. Pyrex Results

Stability of photo-conductivity was studied by observing transient response at a fix voltage immediately after exposing the specimen to a fixed dose rate. As seen in Fig. 2, current rises rapidly and then decreases in an exponential manner. Initial transient behavior of similar shape has been reported previously [20]. However, gamma irradiation relaxation time for Pyrex glass is orders of magnitude larger than reported [20] for ultrafast photoconductive GaAs and AlGaAs.

A typical current versus voltage graph is shown in Fig. 3. In current-voltage graph the straight line shows a linear or Ohmic relationship. It is encouraging to confirm that our results are in agreement with the information available in the literature [21] and with theoretical predictions.

At very high dose rates, of the order of 0.25 Gys^{-1} and higher, the linear relationship between current and voltage was no longer observed. The behavior at these high dose rates is shown in Fig. 4. This change in behavior is attributed to radiation damage.

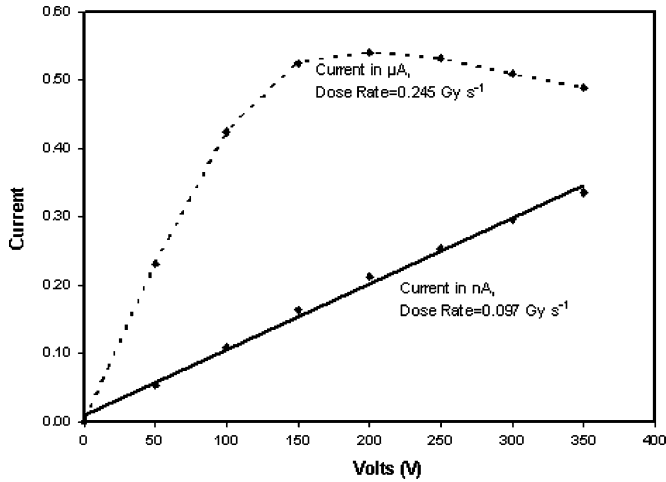

Fig. 4. Pyrex current voltage relationship showing Ohmic response at lower dose rate and non-Ohmic at higher dose rate.

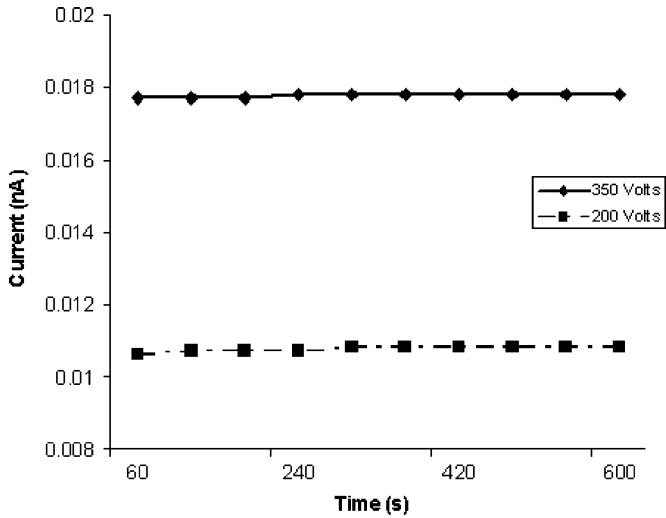

Fig. 5. Quartz transient response of photocurrent in at 0.03 Gys⁻¹.

B. Quartz Results

In the second phase of the research, Quartz was studied for its photoconductive response. Quartz exhibited fast return to steady state photocurrent. Our instrumentation was not capable of recording the ultra-fast transient response therefore we only observed steady photocurrents as shown in Fig. 5. As expected, at higher potential (350 V) the current was observed to be higher than at lower potential (200 V).

Fig. 6 shows almost perfect Ohmic response of Quartz. For all four dose rates tested, Quartz shows almost perfect linear relationship between current and voltage. Moreover, slope of the line depends on the dose rate to which the specimen was exposed. This behavior is consistent with previously reported results [21].

At higher dose rate (in excess of 0.07 Gys⁻¹) Quartz samples seem to experience radiation damage as observed in form of departure from Ohmic response. These effects were found to be transient in nature because after long (24 hours or more) relaxation time the samples returned to their initial behavior.

C. Vycor Results

Vycor is the last material tested in this research. Generally, Vycor behavior was very similar to Quartz in both its transient

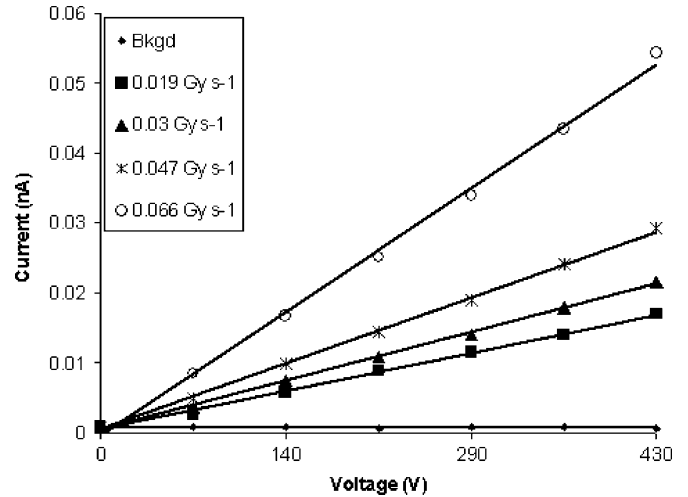

Fig. 6. Quartz current voltage relationship showing Ohmic response.

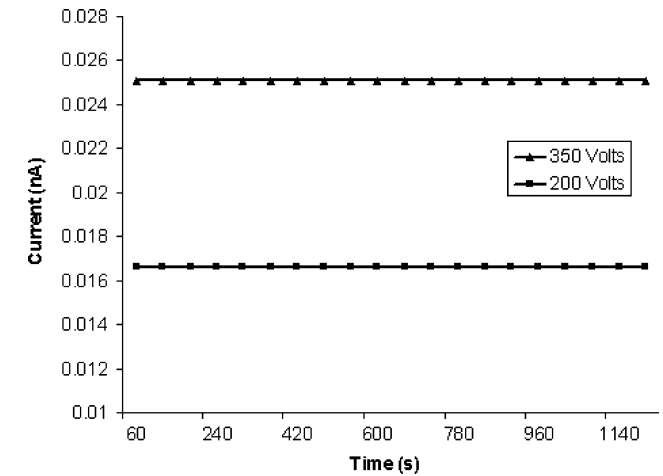

Fig. 7. Vycor transient response of photocurrent in at 0.03 Gys⁻¹.

response and Ohmic relationship. Vycor demonstrate quick return to stability after unobservable transient (Fig. 7). As expected, higher currents are produced at higher voltages. It was also consistently observed that currents for Vycor under similar applied voltages and irradiation conditions were higher than that for Quartz sample under similar conditions. This comparison is obvious in Figs. 5 and 7.

Like Quartz, Fig. 8 also shows a perfect Ohmic response for Vycor samples. For the three dose rates tested the linear relationship between current and voltage seems to hold well. As expected, slope for high dose rate was steeper than that for low dose rate. Vycor however depart from Ohmic response at a lower dose rate of approximately 0.03 Gys⁻¹.

V. DISCUSSION AND CONCLUSION

All our observations are consistent with previous data reported for other materials. We also observed gamma radiation discoloration in Pyrex when exposed to high cumulative doses. A much lesser degree of discoloration was also noticed in Vycor specimen while Quartz did not show any visible effect even after significantly large doses.

Departure from Ohmic behavior was observed in all three materials test at high dose rate. However, the nature of this devia-

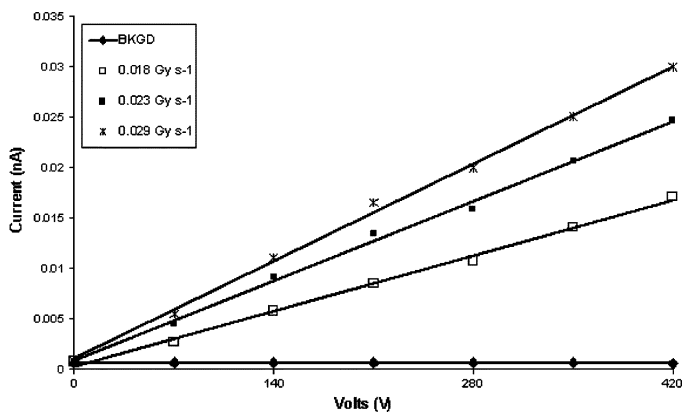

Fig. 8. Vycor current voltage relationship showing Ohmic response.

tion was quite different, in that Pyrex experienced a permanent damage with very long recovery time (in the order of several days or weeks). While both Quartz and Vycor recovered from this damage rather quickly. After approximately a day of relaxation, both Quartz and Vycor returned to their initial behavior. Pyrex was found to endure much larger dose rate before experiencing the non-Ohmic threshold. On the other hand, Vycor had a much lower threshold while Quartz displayed relatively better radiation endurance. Quartz departure from Ohmic response was observed at approximately 0.07 Gys^{-1} , while Vycor threshold was reached at half of this value.

Subsequently, both Vycor and Quartz were exposed to prolonged irradiations. Quartz was exposed to gamma continuously for 121 hours at a dose rate of 0.03 Gys^{-1} . During this prolonged period of irradiation a slight upward trend in current was observed with fluctuations.

When a similar prolonged (168 hours) exposure was performed for Vycor, a similar upward trend was observed with very little or no fluctuations. It is difficult to draw any firm conclusion from the observation as electronic drift may be responsible for the observed drift.

Using the slope of the current-voltage lines an effective photoconductivity (σ_p) of the material was computed for each observed dose rate. Using photoconductivity data as a function of dose rate, the value of x was computed by regression of (1). For Pyrex, apparently due to radiation damage the value of x was found to be 1.4, much larger than expected. Quartz produced $x = 0.55$. This result is quite close to the expected value of 0.5 based on the theoretical prediction for high purity material. Vycor data produced $x = 1.2$ which is again a little higher than expected.

Our experimental results indicated that in principle the use of photoconductivity for gamma dose measurement is possible. However, Pyrex dosimeter with our fabrication technique will not perform well. Vycor appears to be the best of the three materials tested from detector construction point of view. Comparison of Quartz and Vycor data indicated that a very precise control over impurity level would be necessary for a successful dosimeter design.

Experimental observation reported in this paper may also be significant for research using these or similar materials in high radiation environment. Kang and co-worker [22] discussed most

important issues associated with direct detection of X-ray for diagnostic imaging using HgI_2 and PbI_2 . High leakage current and leakage current drift was noted to be one of the main challenges. Our data may be helpful in a careful analysis of substrate material's photoconductive response which may eventually lead to better material selection and possibly devising a correction scheme for leakage currents.

REFERENCES

- [1] W. J. Weber, R. C. Ewing, C. A. Angell, G. W. Arnold, A. N. Cormack, J. M. Delage, D. L. Griscom, L. W. Hobbs, A. Navrotsky, D. L. Price, A. M. Stoneham, and M. C. Weinberg, "Radiation effects in glasses used for the immobilization of high-level waste and plutonium disposition," *J. Mater. Res.*, vol. 12, no. 8, pp. 1946–1975, 1997.
- [2] C. L. Allred, "Effect of radiation on silicon and borosilicate glass," Ph.D. dissertation, Materials Sci. Eng., Mass. Inst. Tech., Cambridge, MA, 2003.
- [3] J. E. McIlvaine, "The effect of gamma sterilization on glass-reinforced and lubricated thermoplastics," *Medical Plastics Biomaterials*, p. 49, Jan. 1997.
- [4] R. Huettneraich and K. Matthey, "Radiation-induced discoloration of glass medicine bottles," in *Proc. 2nd Conf. Applied Physical Chemistry*, Budapest, Aug. 1971, pp. 635–643.
- [5] Radiation-Induced Discoloration [Online]. Available: <http://www.birns.com/gis/gisbrowning.htm>
- [6] H. Doweidar, M. A. Abou Zeid, and G. M. El-Damrawy, "Effect of gamma radiation and thermal treatment on some physical properties of $\text{ZnO-PbO-B}_2\text{O}_3$ glasses," *J. Phys. D: Appl. Phys.*, vol. 24, pp. 2222–2228, Dec. 1991.
- [7] G. Mathew and J. Philip, "Characteristics of photoconductivity in As-Sb-Se glasses," *Pramana J. Phys.*, vol. 53, no. 5, pp. 891–902, Aug. 1999.
- [8] J. F. Federici and D. M. Bubb, "The role of defects in persistent photoconductivity in $\text{YBa}_2\text{Cu}_3\text{O}_{6+x}$," *J. Supercond.: Incorporating Novel Magnetism*, vol. 14, no. 2, pp. 331–340, 2001.
- [9] S. Singh, R. S. Sharma, R. K. Shukla, and A. Kumar, "Steady state photoconductivity in $\text{A-Ge}_{90}\text{Ge}_{10-x}\text{In}_x$ thin films," *J. Optoelectron. Adv. Mater.*, vol. 6, no. 3, pp. 769–776, Sep. 2004.
- [10] M. S. Lazo, D. M. Wodall, and P. J. McDaniel, "Radiation damage analysis for state-of-the-art microelectronics," in *Space Nuclear Power System*. Malabar, FL: Orbit, 1986.
- [11] N. V. Joshi, *Selected papers on photoconductivity*. Bellingham, WA: SPIE Optical Engineering Press, 1992.
- [12] J. N. Anno, *Notes on Radiation Effects on Materials*. New York: Hemisphere, 1984, pp. 76–100.
- [13] J. W. Winslow and R. S. Alger, "Radiation-induced currents in solids organic insulators," *USNRDL-TR-326, US Navy Radiological Defense Laboratory*, 1959.
- [14] V. E. Culler, H. E. Rexford, and W. H. Barney, "Gamma radiation induced conductivity in solids insulators," presented at the AIEE Conference, 1960. Paper CP 60-1085.
- [15] W. C. Riley, W. G. Coppins, and W. H. Duckworth, "The effect of nuclear radiation in glass," *Radiation Effects Information of Nuclear Center Technical Memorandum no. 9*, Nov. 30, 1958.
- [16] R. E. Chrien, "Radiation-induced conductivity in glass," M.S. thesis, Rensselaer Polytechnic Institute, Troy, NY, 1952.
- [17] G. F. Knoll, *Radiation Detection and Measurements*. New York: Wiley, 2000, pp. 103–127.
- [18] N. Tsoufanidis, *Measurement and Detection of Radiation*. New York: McGraw-Hill, 1983, pp. 187–189.
- [19] L. Shoaib, "Development of photoconductive gamma dosimeter," M.S. thesis, Univ. Cincinnati, Cincinnati, OH, 1995.
- [20] D. Cooke, Z. Wu, X. Mei, J. Liu, H. E. Ruda, K. L. Kavanagh, and F. A. Hegmann, "Transient Photoconductivity of GaAs and AlGaAs Nanowires. The Canadian Institute for Photonic Innovations (CIPI). [Online]. Available: <http://www.cipi.ulaval.ca/publications/publications/>
- [21] J. N. Anno, "Factors influencing the effects of reactor radiation on electrical components," *Nucl. Applicat.*, vol. 2, pp. 371–378, 1966.
- [22] Y. Kang, L. E. Antonuk, Y. El-Mohri, L. Hu, Y. Li, A. Sawant, A. Su, Y. Wang, J. Yamamoto, and Q. Zhao, "Examination of PbI_2 and HgI_2 photoconductive materials for direct detection, active matrix flat-panel imagers for diagnostic X-ray imaging," *IEEE Trans. Nucl. Sci.*, vol. 52, no. 1, pp. 38–45, Feb. 2005.